

## **SYSMAC CP Series**

**CP1E-E□□SD□-□**

**CP1E-N□□S□D□-□**

**CP1E-E□□D□-□**

**CP1E-N□□D□-□**

**CP1E-NA□□D□-□**

# **CP1E CPU Unit Software**

## **USER'S MANUAL**

**OMRON**

## **NOTE**

All rights reserved. No part of this publication may be reproduced, stored in a retrieval system, or transmitted, in any form, or by any means, mechanical, electronic, photocopying, recording, or otherwise, without the prior written permission of OMRON.

No patent liability is assumed with respect to the use of the information contained herein. Moreover, because OMRON is constantly striving to improve its high-quality products, the information contained in this manual is subject to change without notice. Every precaution has been taken in the preparation of this manual. Nevertheless, OMRON assumes no responsibility for errors or omissions. Neither is any liability assumed for damages resulting from the use of the information contained in this publication.

## **Trademarks**

- Microsoft, Windows are either registered trademarks or trademarks of Microsoft Corporation in the United States and other countries.

Other company names and product names in this document are the trademarks or registered trademarks of their respective companies.

## **Copyrights**

Microsoft product screen shots reprinted with permission from Microsoft Corporation.



**SYSMAC CP Series**  
**CP1E-E□□SD□-□**  
**CP1E-N□□S□D□-□**  
**CP1E-E□□D□-□CP1E-**  
**N□□D□-□CP1E-NA□□**  
**D□-□CP1E CPU Unit**  
**Software**

**User's Manual**

*Revised September 2022*



# Introduction

---

Thank you for purchasing a SYSMAC CP-series CP1E Programmable Controller.

This manual contains information required to use the CP1E. Read this manual completely and be sure you understand the contents before attempting to use the CP1E.

## Intended Audience

This manual is intended for the following personnel, who must also have knowledge of electrical systems (an electrical engineer or the equivalent).

- Personnel in charge of installing FA systems
- Personnel in charge of designing FA systems
- Personnel in charge of managing FA systems and facilities

## Applicable Products

### ● CP-series CP1E CPU Units

- Basic Models CP1E-E□□(S)D□-□  
A basic model of CPU Unit that support basic control applications using instructions such as basic, movement, arithmetic, and comparison instructions.
- Application Models CP1E-N/NA□□(S□)D□-□  
An application model of CPU Unit that supports connections to Programmable Terminals, inverters, and servo drives.

The CP Series is centered around the CP1H, CP1L, and CP1E CPU Units and is designed with the same basic architecture as the CS and CJ Series.

Always use CP-series Expansion Units and CP-series Expansion I/O Units when expanding I/O capacity. I/O words are allocated in the same way as for the CPM1A/CPM2A PLCs, i.e., using fixed areas for inputs and outputs.

# CP1E CPU Unit Manuals

Information on the CP1E CPU Units is provided in the following manuals.  
Refer to the appropriate manual for the information that is required.

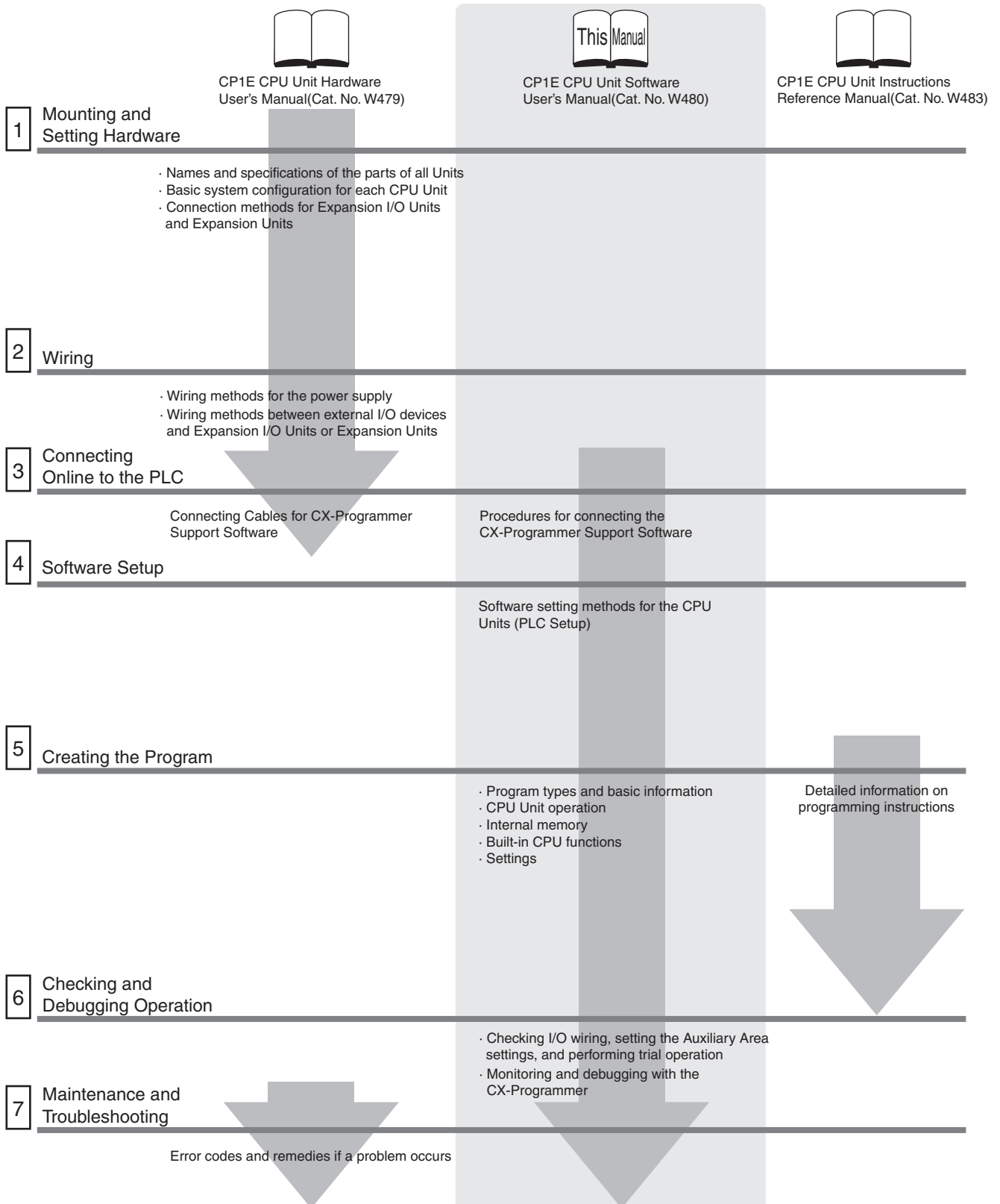

## Manual Configuration

The CP1E CPU manuals are organized in the sections listed in the following tables. Refer to the appropriate section in the manuals as required.

### CP1E CPU Unit Software User's Manual (Cat. No. W480) (This Manual)

Section	Contents
<b>Section 1 Overview</b>	This section gives an overview of the CP1E, describes its application procedures.
<b>Section 2 CPU Unit Memory</b>	This section describes the types of internal memory in a CP1E CPU Unit and the data that is stored.
<b>Section 3 CPU Unit Operation</b>	This section describes the operation of a CP1E CPU Unit.
<b>Section 4 Programming Concepts</b>	This section provides basic information on designing ladder programs for a CP1E CPU Unit.
<b>Section 5 I/O Memory</b>	This section describes the types of I/O memory areas in a CP1E CPU Unit and the details.
<b>Section 6 I/O Allocation</b>	This section describes I/O allocation used to exchange data between the CP1E CPU Unit and other units.
<b>Section 7 PLC Setup</b>	This section describes the PLC Setup, which are used to perform basic settings for a CP1E CPU Unit.
<b>Section 8 Overview and Allocation of Built-in Functions</b>	This section lists the built-in functions and describes the overall application flow and the allocation of the functions.
<b>Section 9 Quick-response Inputs</b>	This section describes the quick-response inputs that can be used to read signals that are shorter than the cycle time.
<b>Section 10 Interrupts</b>	This section describes the interrupts that can be used with CP1E PLCs, including input interrupts and scheduled interrupts.
<b>Section 11 High-speed Counters</b>	This section describes the high-speed counter inputs, high-speed counter interrupts, and the frequency measurement function.
<b>Section 12 Pulse Outputs</b>	This section describes positioning functions such as trapezoidal control, jogging, and origin searches.
<b>Section 13 PWM Outputs</b>	This section describes the variable-duty-factor pulse (PWM) outputs.
<b>Section 14 Serial Communications</b>	This section describes communications with Programmable Terminals (PTs) without using communications programming, no-protocol communications with general components, and connections with a Modbus-RTU Easy Master, Serial PLC Link, and host computer.
<b>Section 15 Analog I/O Function</b>	This section describes the built-in analog function for NA-type CPU Units.
<b>Section 16 Built-in Functions</b>	This section describes PID temperature control, clock functions, DM backup functions, security functions.
<b>Section 17 Ethernet Option Board</b>	This section gives an overview of the Ethernet Option Board, describes its setting methods, I/O memory allocations, troubleshooting, how to connect the CX-Programmer, and how to install an Ethernet network.
<b>Section 18 Analog Option Board</b>	This section describes an overview of the Analog Option Board, describes its installation and setting methods, memory allocations, start-up operation, refresh time, troubleshooting and how to use the Analog Option Board.
<b>Section 19 Operating the Programming Device</b>	This section describes basic functions of the CX-Programmer, such as using the CX-Programmer to write ladder programs to control the CP1E CPU Unit, to transfer the programs to the CP1E CPU Unit, and to debug the programs.
<b>Appendices</b>	The appendices provide lists of programming instructions, the Auxiliary Area, cycle time response performance, PLC performance at power interruptions.

## CP1E CPU Unit Hardware User's Manual (Cat. No. W479)

Section	Contents
<b>Section 1 Overview and Specifications</b>	This section gives an overview of the CP1E, describes its features, and provides its specifications.
<b>Section 2 Basic System Configuration and Devices</b>	This section describes the basic system configuration and unit models of the CP1E.
<b>Section 3 Part Names and Functions</b>	This section describes the part names and functions of the CPU Unit, Expansion I/O Units, and Expansion Units in a CP1E PLC .
<b>Section 4 Programming Device</b>	This section describes the features of the CX-Programmer used for programming and debugging PLCs, as well as how to connect the PLC with the Programming Device by USB.
<b>Section 5 Installation and Wiring</b>	This section describes how to install and wire CP1E Units.
<b>Section 6 Troubleshooting</b>	This section describes how to troubleshoot problems that may occur with a CP1E PLC, including the error indications provided by the CP1E Units.
<b>Section 7 Maintenance and Inspection</b>	This section describes periodic inspections, the service life of the Battery, and how to replace the Battery.
<b>Section 8 Using Expansion Units and Expansion I/O Units</b>	This section describes application methods for Expansion Units.
<b>Appendices</b>	The appendices provide information on dimensions, wiring diagrams, and wiring serial communications for the CP1E.

## CP1E CPU Unit Instructions Reference Manual (Cat. No. W483)

Section	Contents
<b>Section 1 Summary of Instructions</b>	This section provides a summary of instructions used with a CP1E CPU Unit.
<b>Section 2 Instruction</b>	This section describes the functions, operands and sample programs of the instructions that are supported by a CP1E CPU Unit.
<b>Section 3 Instruction Execution Times and Number of Steps</b>	This section provides the execution times for all instructions used with a CP1E CPU Unit.
<b>Section 4 Monitoring and Computing the Cycle Time</b>	This section describes how to monitor and calculate the cycle time of a CP1E CPU Unit that can be used in the programs.
<b>Appendices</b>	The appendices provide a list of instructions by Mnemonic and ASCII code table for the CP1E CPU Unit.

# Manual Structure

## Page Structure and Icons



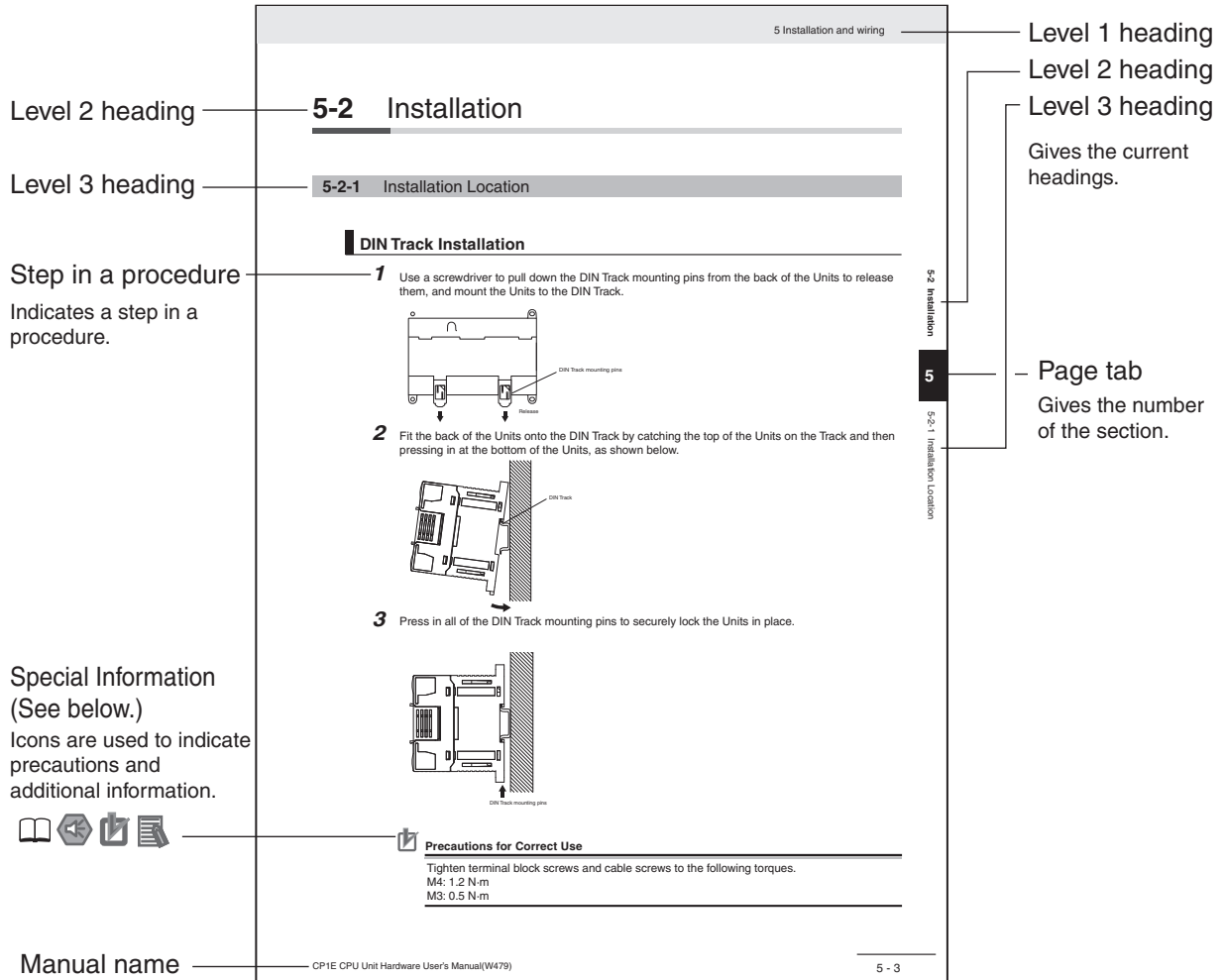

The following page structure and icons are used in this manual.



This illustration is provided only as a sample and may not literally appear in this manual.

## Special Information

Special information in this manual is classified as follows:

-  **Precautions for Safe Use**  
Precautions on what to do and what not to do to ensure using the product safely.
-  **Precautions for Correct Use**  
Precautions on what to do and what not to do to ensure proper operation and performance.
-  **Additional Information**  
Additional information to increase understanding or make operation easier.
-  **References**  
References to the location of more detailed or related information.

## Terminology and Notation

Term	Description
<b>E-type CPU Unit</b>	<p>A basic model of CPU Unit that support basic control applications using instructions such as basic, movement, arithmetic, and comparison instructions.</p> <p>Basic models of CPU Units are called “E□□(S)-type CPU Units” in this manual.</p> <p>The models of E□□(S)-type CPU Units are shown below.</p> <p>CP1E-E□□D□-□ CP1E-E□□SD□-□</p>
<b>N-type CPU Unit</b>	<p>An application model of CPU Unit that supports connections to Programmable Terminals, inverters, and servo drives.</p> <p>Application models of CPU Units are called “N□□(S)-type CPU Units” in this manual.</p> <p>The models of N□□(S)-type CPU Units are shown below.</p> <p>CP1E-N□□D□-□ CP1E-N□□SD□-□ CP1E-N□□S1D□-□</p>
<b>NA-type CPU Unit</b>	<p>An application model of CPU Unit that supports built-in analog and connections to Programmable Terminals, inverters, and servo drives.</p> <p>Application models of CPU Units with built-in analog are called “NA-type CPU Units” in this manual.</p>
<b>CX-Programmer</b>	<p>A programming device that applies for programming and debugging PLCs.</p> <p>The CX-Programmer includes the Micro PLC Edition CX-Programmer (CX-One Lite), the CX-Programmer (CX-One) and the CX-Programmer for CP1E.</p> <p>This manual describes the unique applications and functions of the Micro PLC Edition CX-Programmer version 9.03 or higher/CX-Programmer for CP1E.</p> <p>“CX-Programmer” refers to the Micro PLC Edition CX-Programmer version 9.03 or higher/ CX-Programmer for CP1E in this manual.</p> <p><b>Note</b> E20/30/40(S) and N20/30/40(S□) CPU Units are supported by CX-Programmer version 8.2 or higher. E10/14(S), N14/60(S□) and NA20 CPU Units are supported by CX-Programmer version 9.03 or higher. E60S CPU Units are supported by CX-Programmer version 9.42 or higher.</p>

# Sections in this Manual

---

<b>1</b>	<b>Overview</b>	<b>11</b>	<b>High-speed Counters</b>	<b>1</b>	<b>11</b>
<b>2</b>	<b>Internal Memory in the CPU Unit</b>	<b>12</b>	<b>Pulse Outputs</b>	<b>2</b>	<b>12</b>
<b>3</b>	<b>CPU Unit Operation</b>	<b>13</b>	<b>PWM Outputs</b>	<b>3</b>	<b>13</b>
<b>4</b>	<b>Understanding Programming</b>	<b>14</b>	<b>Serial Communications</b>	<b>4</b>	<b>14</b>
<b>5</b>	<b>I/O Memory</b>	<b>15</b>	<b>Analog I/O Function</b>	<b>5</b>	<b>15</b>
<b>6</b>	<b>I/O Allocation</b>	<b>16</b>	<b>Other Functions</b>	<b>6</b>	<b>16</b>
<b>7</b>	<b>PLC Setup</b>	<b>17</b>	<b>Ethernet Option Board</b>	<b>7</b>	<b>17</b>
<b>8</b>	<b>Overview of Built-in Functions and Allocations</b>	<b>18</b>	<b>Analog Option Board</b>	<b>8</b>	<b>18</b>
<b>9</b>	<b>Quick-response Inputs</b>	<b>19</b>	<b>Programming Device Operations</b>	<b>9</b>	<b>19</b>
<b>10</b>	<b>Interrupts</b>	<b>A</b>	<b>Appendices</b>	<b>10</b>	<b>APP</b>

# CONTENTS

---

Introduction .....	1
CP1E CPU Unit Manuals .....	2
Manual Structure .....	5
Terms and Conditions Agreement.....	15
Safety Precautions .....	17
Precautions for Safe Use.....	22
Regulations and Standards.....	24
Related Manuals .....	25

## Section 1 Overview

---

1-1 CP1E Overview .....	1-2
1-1-1 Overview of Features .....	1-2
1-2 Basic Operating Procedure .....	1-4
1-3 Difference between E/N/NA□□-type and E/N□□S(1)-type .....	1-5

## Section 2 Internal Memory in the CPU Unit

---

2-1 Internal Memory in the CPU Unit.....	2-2
2-1-1 CPU Unit Memory Backup Structure.....	2-2
2-1-2 Memory Areas and Stored Data.....	2-3
2-1-3 Transferring Data from a Programming Device .....	2-4
2-1-4 Backup .....	2-4

## Section 3 CPU Unit Operation

---

3-1 CPU Unit Operation .....	3-2
3-1-1 Overview of CPU Unit Operation .....	3-2
3-1-2 CPU Unit Operating Modes.....	3-3
3-2 Backing Up Memory .....	3-5
3-2-1 CPU Unit Memory Configuration.....	3-5
3-2-2 Backing Up Ladder Programs and PLC Setup.....	3-6
3-2-3 I/O Memory Backup .....	3-6
3-2-4 Initializing I/O Memory at Startup .....	3-8

## Section 4 Understanding Programming

---

4-1 Programming .....	4-2
4-1-1 User Programs .....	4-2
4-1-2 Program Capacity .....	4-3
4-1-3 Basics of Programming.....	4-3
4-2 Tasks, Sections, and Symbols .....	4-6
4-2-1 Overview of Tasks.....	4-6



4-2-2	Overview of Sections .....	4-6
4-2-3	Overview of Symbols .....	4-6
<b>4-3</b>	<b>Programming Instructions.....</b>	<b>4-8</b>
4-3-1	Basic Understanding of Instructions.....	4-8
4-3-2	Operands .....	4-9
4-3-3	Instruction Variations.....	4-10
4-3-4	Execution Conditions .....	4-10
4-3-5	Specifying Data in Operands .....	4-12
4-3-6	Data Formats .....	4-13
4-3-7	I/O Refresh Timing.....	4-15
<b>4-4</b>	<b>Constants .....</b>	<b>4-16</b>
<b>4-5</b>	<b>Specifying Offsets for Addresses .....</b>	<b>4-19</b>
4-5-1	Overview .....	4-19
4-5-2	Application Examples for Address Offsets.....	4-21
<b>4-6</b>	<b>Ladder Programming Precautions.....</b>	<b>4-22</b>
4-6-1	Special Program Sections.....	4-22

## Section 5 I/O Memory

---

<b>5-1</b>	<b>Overview of I/O Memory Areas.....</b>	<b>5-2</b>
5-1-1	I/O Memory Areas.....	5-2
5-1-2	I/O Memory Area Address Notation .....	5-5
5-1-3	I/O Memory Areas.....	5-6
<b>5-2</b>	<b>I/O Bits .....</b>	<b>5-7</b>
<b>5-3</b>	<b>Work Area (W).....</b>	<b>5-8</b>
<b>5-4</b>	<b>Holding Area (H) .....</b>	<b>5-9</b>
<b>5-5</b>	<b>Data Memory Area (D) .....</b>	<b>5-11</b>
<b>5-6</b>	<b>Timer Area (T) .....</b>	<b>5-13</b>
<b>5-7</b>	<b>Counter Area (C).....</b>	<b>5-15</b>
<b>5-8</b>	<b>Auxiliary Area (A) .....</b>	<b>5-17</b>
<b>5-9</b>	<b>Condition Flags .....</b>	<b>5-19</b>
<b>5-10</b>	<b>Clock Pulses .....</b>	<b>5-21</b>

## Section 6 I/O Allocation

---

<b>6-1</b>	<b>Allocation of Input Bits and Output Bits .....</b>	<b>6-2</b>
6-1-1	I/O Allocation.....	6-2
6-1-2	I/O Allocation Concepts.....	6-3
6-1-3	Allocations on the CPU Unit.....	6-3
6-1-4	Allocations to Expansion Units and Expansion I/O Units.....	6-4

## Section 7 PLC Setup

---

<b>7-1</b>	<b>Overview of the PLC Setup.....</b>	<b>7-2</b>
<b>7-2</b>	<b>PLC Setup Settings .....</b>	<b>7-3</b>
7-2-1	Startup and CPU Unit Settings.....	7-3
7-2-2	Timing and Interrupt Settings.....	7-3
7-2-3	Input Constant Settings.....	7-4
7-2-4	Built-in RS-232C Port.....	7-5
7-2-5	Serial Option Port / Built-in RS-485 Port.....	7-8
7-2-6	Built-in Inputs .....	7-11
7-2-7	Pulse Output 0 Settings .....	7-13

7-2-8	Pulse Output 1 Settings .....	7-14
7-2-9	Built-in AD/DA: Built-in Analog I/O Settings .....	7-16

## Section 8 Overview of Built-in Functions and Allocations

---

<b>8-1</b>	<b>Built-in Functions .....</b>	<b>8-2</b>
<b>8-2</b>	<b>Overall Procedure for Using CP1E Built-in Functions .....</b>	<b>8-3</b>
<b>8-3</b>	<b>Terminal Allocations for Built-in Functions .....</b>	<b>8-4</b>
8-3-1	Specifying the Functions to Use.....	8-4
8-3-2	Selecting Functions in the PLC Setup.....	8-4
8-3-3	Allocating Built-in Input Terminals.....	8-6
8-3-4	Allocating Built-in Output Temrnals.....	8-8

## Section 9 Quick-response Inputs

---

<b>9-1</b>	<b>Quick-response Inputs.....</b>	<b>9-2</b>
9-1-1	Overview .....	9-2
9-1-2	Flow of Operation.....	9-3

## Section 10 Interrupts

---

<b>10-1</b>	<b>Interrupts.....</b>	<b>10-2</b>
10-1-1	Overview .....	10-2
<b>10-2</b>	<b>Input Interrupts .....</b>	<b>10-3</b>
10-2-1	Overview .....	10-3
10-2-2	Flow of Operation.....	10-4
10-2-3	Application Example.....	10-7
<b>10-3</b>	<b>Scheduled Interrupts.....</b>	<b>10-10</b>
10-3-1	Overview .....	10-10
10-3-2	Flow of Operation.....	10-11
<b>10-4</b>	<b>Precautions for Using Interrupts.....</b>	<b>10-13</b>
10-4-1	Interrupt Task Priority and Order of Execution.....	10-13
10-4-2	Related Auxiliary Area Words and Bits .....	10-13
10-4-3	Duplicate Processing in each Task.....	10-13

## Section 11 High-speed Counters

---

<b>11-1</b>	<b>Overview.....</b>	<b>11-2</b>
11-1-1	Overview .....	11-2
11-1-2	Flow of Operation.....	11-3
11-1-3	Specifications.....	11-7
<b>11-2</b>	<b>High-speed Counter Inputs.....</b>	<b>11-8</b>
11-2-1	Pulse Input Methods Settings .....	11-8
11-2-2	Counting Ranges Settings .....	11-10
11-2-3	Reset Methods.....	11-11
11-2-4	Reading the Present Value .....	11-12
11-2-5	Frequency Measurement .....	11-13
<b>11-3</b>	<b>High-speed Counter Interrupts.....</b>	<b>11-14</b>
11-3-1	Overview .....	11-14
11-3-2	Present Value Comparison .....	11-17
11-3-3	High-speed Counter Interrupt Instruction .....	11-21
<b>11-4</b>	<b>Related Auxiliary Area Bits and Words .....</b>	<b>11-26</b>
<b>11-5</b>	<b>Application Example .....</b>	<b>11-27</b>

## Section 12 Pulse Outputs

---

<b>12-1 Overview</b> .....	<b>12-2</b>
12-1-1 Overview.....	12-2
12-1-2 Flow of Operation.....	12-4
12-1-3 Specifications.....	12-12
<b>12-2 Positioning Control</b> .....	<b>12-13</b>
12-2-1 Positioning Control Configuration.....	12-13
12-2-2 Relative Positioning and Absolute Positioning.....	12-13
12-2-3 Application Example.....	12-15
<b>12-3 Jogging</b> .....	<b>12-17</b>
12-3-1 High-speed Jogging.....	12-17
12-3-2 Low-speed Jogging.....	12-17
12-3-3 Application Example.....	12-17
<b>12-4 Defining Origin Position</b> .....	<b>12-20</b>
12-4-1 Origin Searches.....	12-20
12-4-2 Flow of Operation.....	12-21
12-4-3 Settings in PLC Setup.....	12-21
12-4-4 Origin Search Instructions.....	12-24
12-4-5 Origin Search Operations.....	12-25
12-4-6 Origin Return.....	12-32
12-4-7 Changing the Present Value of the Pulse Output.....	12-33
<b>12-5 Reading the Pulse Output Present Value</b> .....	<b>12-34</b>
<b>12-6 Related Auxiliary Area Flags</b> .....	<b>12-35</b>
<b>12-7 Application Examples</b> .....	<b>12-36</b>
12-7-1 Vertically Conveying PCBs (Multiple Progressive Positioning).....	12-36
12-7-2 Feeding Wrapping Material: Interrupt Feeding.....	12-41
<b>12-8 Precautions when Using Pulse Outputs</b> .....	<b>12-45</b>
<b>12-9 Pulse Output Pattern</b> .....	<b>12-50</b>
12-9-1 Speed Control (Continuous Mode).....	12-50
12-9-2 Positioning Control (Independent Mode).....	12-52

## Section 13 PWM Outputs

---

<b>13-1 PWM Outputs (Variable-duty-factor Pulse Outputs)</b> .....	<b>13-2</b>
13-1-1 Flow of Operation.....	13-3
13-1-2 Ladder Program Example.....	13-4

## Section 14 Serial Communications

---

<b>14-1 Serial Communications</b> .....	<b>14-2</b>
14-1-1 Types of CPU Units and Serial Ports.....	14-2
14-1-2 Overview of Serial Communications.....	14-3
<b>14-2 Program-free Communications with Programmable Terminals</b> .....	<b>14-5</b>
14-2-1 Overview.....	14-5
14-2-2 Flow of Connection.....	14-6
14-2-3 PLC Setup and PT System Settings.....	14-6
<b>14-3 No-protocol Communications with General Components</b> .....	<b>14-8</b>
14-3-1 Overview.....	14-8
14-3-2 Flow of Operation.....	14-9
14-3-3 PLC Setup.....	14-9
14-3-4 Related Auxiliary Area Bits and Words.....	14-10
<b>14-4 Modbus-RTU Easy Master Function</b> .....	<b>14-11</b>
14-4-1 Overview.....	14-11
14-4-2 Flow of Operation.....	14-11

14-4-3	Setting and Word Allocation.....	14-12
14-4-4	Programming Examples.....	14-14
<b>14-5</b>	<b>Serial PLC Links .....</b>	<b>14-20</b>
14-5-1	Overview .....	14-20
14-5-2	Flow of Operation.....	14-21
14-5-3	PLC Setup.....	14-21
14-5-4	Operating Specifications .....	14-23
14-5-5	Example Application.....	14-29
<b>14-6</b>	<b>Connecting the Host Computer .....</b>	<b>14-31</b>
14-6-1	Overview .....	14-31
14-6-2	Flow of Operation.....	14-31
14-6-3	Command/response Format and List of Commands .....	14-32
<b>14-7</b>	<b>Precautions on the usage of RS-485 .....</b>	<b>14-34</b>

## Section 15 Analog I/O Function

---

<b>15-1</b>	<b>Overview.....</b>	<b>15-2</b>
15-1-1	Flow of Operation.....	15-2
15-1-2	Analog I/O Specifications .....	15-6
<b>15-2</b>	<b>Analog Input and Output Signal Ranges.....</b>	<b>15-7</b>
15-2-1	Analog Input Signal Ranges.....	15-7
15-2-2	Analog Output Signal Ranges.....	15-9
15-2-3	Special functions.....	15-11
<b>15-3</b>	<b>I/O Allocation and Related Auxiliary Area Flags.....</b>	<b>15-12</b>
15-3-1	I/O Allocation.....	15-12
15-3-2	Related Auxiliary Area Flags.....	15-12

## Section 16 Other Functions

---

<b>16-1</b>	<b>PID Temperature Control .....</b>	<b>16-2</b>
16-1-1	Overview .....	16-2
16-1-2	Flow of Operation.....	16-3
16-1-3	Application Example.....	16-4
<b>16-2</b>	<b>Clock.....</b>	<b>16-7</b>
<b>16-3</b>	<b>DM Backup Function .....</b>	<b>16-8</b>
16-3-1	Backing Up and Restoring DM Area Data.....	16-8
16-3-2	Procedure.....	16-10
<b>16-4</b>	<b>Security Functions .....</b>	<b>16-12</b>
16-4-1	Ladder Program Read Protection .....	16-12
16-4-2	Protecting Program Execution Using the Lot Number .....	16-14

## Section 17 Ethernet Option Board

---

<b>17-1</b>	<b>Features and Specifications.....</b>	<b>17-2</b>
17-1-1	Ethernet Option Board Function Guide.....	17-2
17-1-2	Features .....	17-3
17-1-3	Specifications.....	17-5
17-1-4	Software Configuration.....	17-5
17-1-5	FINS Communications .....	17-6
17-1-6	Differences in version of the Ethernet Option Board.....	17-8
<b>17-2</b>	<b>Startup Procedure .....</b>	<b>17-9</b>
17-2-1	Startup Procedure.....	17-9
<b>17-3</b>	<b>Settings .....</b>	<b>17-11</b>
17-3-1	Ethernet Option Board Setup.....	17-11

17-3-2	Transferring Data from the CPU Unit.....	17-12
17-3-3	Default Settings .....	17-13
17-3-4	Web Browser Setting Function .....	17-15
<b>17-4</b>	<b>Memory Allocations .....</b>	<b>17-26</b>
17-4-1	DM Area Allocation .....	17-26
17-4-2	CIO Area Allocation .....	17-31
<b>17-5</b>	<b>Trouble Shooting.....</b>	<b>17-33</b>
17-5-1	Error Log.....	17-33
17-5-2	Error Codes .....	17-34
17-5-3	Error Status.....	17-36
<b>17-6</b>	<b>Connection Method with the CX-Programmer .....</b>	<b>17-37</b>
<b>17-7</b>	<b>Network Installation .....</b>	<b>17-40</b>
17-7-1	Devices Required for Constructing a Network.....	17-40
17-7-2	Network Installation .....	17-40
<b>17-8</b>	<b>Comparison with Previous Models.....</b>	<b>17-42</b>
<b>17-9</b>	<b>Buffer Configuration (CP1W-CIF41).....</b>	<b>17-43</b>

## Section 18 Analog Input/Output Option Board

---

<b>18-1</b>	<b>General Specifications.....</b>	<b>18-2</b>
<b>18-2</b>	<b>Part Names .....</b>	<b>18-3</b>
<b>18-3</b>	<b>Installation and Setting .....</b>	<b>18-4</b>
18-3-1	Installation.....	18-4
18-3-2	Setting .....	18-4
18-3-3	Removing.....	18-5
<b>18-4</b>	<b>Memory Allocation .....</b>	<b>18-6</b>
18-4-1	CIO Area Allocation .....	18-6
18-4-2	Auxiliary Area Allocation.....	18-6
<b>18-5</b>	<b>Analog Input Option Board.....</b>	<b>18-7</b>
18-5-1	Main Specifications.....	18-7
18-5-2	Analog Input Signal Ranges .....	18-7
18-5-3	Wiring.....	18-8
<b>18-6</b>	<b>Analog Output Option Board.....</b>	<b>18-11</b>
18-6-1	Main Specifications.....	18-11
18-6-2	Analog Output Signal Ranges .....	18-11
18-6-3	Wiring.....	18-12
<b>18-7</b>	<b>Analog I/O Option Board.....</b>	<b>18-15</b>
18-7-1	Main Specifications.....	18-15
18-7-2	Analog I/O Signal Ranges .....	18-15
18-7-3	Wiring.....	18-17
<b>18-8</b>	<b>Startup Operation .....</b>	<b>18-20</b>
<b>18-9</b>	<b>Analog Option Board Refresh Time.....</b>	<b>18-21</b>
<b>18-10</b>	<b>Trouble Shooting.....</b>	<b>18-22</b>
<b>18-11</b>	<b>The Use of Analog Option Board .....</b>	<b>18-23</b>
18-11-1	Procedure .....	18-23
18-11-2	Program Example .....	18-24

## Section 19 Programming Device Operations

---

<b>19-1</b>	<b>Programming Devices Usable with the CP1E.....</b>	<b>19-2</b>
<b>19-2</b>	<b>Overview of CX-Programmer.....</b>	<b>19-4</b>
19-2-1	CX-Programmer.....	19-4

19-2-2	CX-Programmer Flow from Startup to Operation.....	19-4
19-2-3	Help.....	19-7
<b>19-3</b>	<b>Creating a Ladder Program .....</b>	<b>19-8</b>
19-3-1	Inputting a Ladder Program .....	19-8
19-3-2	Saving and Reading Ladder Programs.....	19-15
19-3-3	Editing Ladder Programs .....	19-16
<b>19-4</b>	<b>Connecting Online to the CP1E and Transferring the Program.....</b>	<b>19-19</b>
19-4-1	Connecting Online.....	19-19
19-4-2	Changing Operating Modes .....	19-20
19-4-3	Transferring a Ladder Program and the PLC Setup .....	19-21
19-4-4	Starting Operation.....	19-22
<b>19-5</b>	<b>Online Monitoring and Debugging.....</b>	<b>19-24</b>
19-5-1	Monitoring Status .....	19-24
19-5-2	Force-set/Reset Bits.....	19-26
19-5-3	Online Editing.....	19-27

## Section A Appendices

<b>A-1</b>	<b>Instruction Functions .....</b>	<b>A-2</b>
A-1-1	Sequence Input Instructions.....	A-2
A-1-2	Sequence Output Instructions.....	A-3
A-1-3	Sequence Control Instructions.....	A-5
A-1-4	Timer and Counter Instructions.....	A-7
A-1-5	Comparison Instructions .....	A-10
A-1-6	Data Movement Instructions .....	A-12
A-1-7	Data Shift Instructions.....	A-15
A-1-8	Increment/Decrement Instructions .....	A-17
A-1-9	Symbol Math Instructions.....	A-18
A-1-10	Conversion Instructions.....	A-22
A-1-11	Logic Instructions .....	A-26
A-1-12	Special Math Instructions.....	A-27
A-1-13	Floating-point Math Instructions.....	A-27
A-1-14	Table Data Processing Instructions .....	A-30
A-1-15	Data Control Instructions.....	A-31
A-1-16	Subroutine Instructions .....	A-35
A-1-17	Interrupt Control Instructions.....	A-36
A-1-18	High-speed Counter/Pulse Output Instructions.....	A-37
A-1-19	Step Instructions .....	A-44
A-1-20	Basic I/O Unit Instructions.....	A-45
A-1-21	Serial Communications Instructions.....	A-49
A-1-22	Clock Instructions.....	A-50
A-1-23	Failure Diagnosis Instructions .....	A-51
A-1-24	Other Instructions.....	A-51
<b>A-2</b>	<b>Auxiliary Area Allocations by Address.....</b>	<b>A-52</b>
A-2-1	Read-only Words .....	A-52
A-2-2	Read/Write Words.....	A-70
<b>A-3</b>	<b>Response Performance .....</b>	<b>A-80</b>
A-3-1	I/O Response Time .....	A-80
A-3-2	Interrupt Response Time.....	A-82
A-3-3	Serial PLC Link Response Performance.....	A-83
A-3-4	Pulse Output Start Time.....	A-84
A-3-5	Pulse Output Change Response Time.....	A-84
<b>A-4</b>	<b>PLC Operation for Power Interruptions.....</b>	<b>A-85</b>
	<b>Index .....</b>	<b>1-1</b>
	<b>Revision History .....</b>	<b>Revision-1</b>

# Terms and Conditions Agreement

---

## Warranty, Limitations of Liability

### Warranties

---

- **Exclusive Warranty**

Omron's exclusive warranty is that the Products will be free from defects in materials and workmanship for a period of twelve months from the date of sale by Omron (or such other period expressed in writing by Omron). Omron disclaims all other warranties, express or implied.

- **Limitations**

OMRON MAKES NO WARRANTY OR REPRESENTATION, EXPRESS OR IMPLIED, ABOUT NON-INFRINGEMENT, MERCHANTABILITY OR FITNESS FOR A PARTICULAR PURPOSE OF THE PRODUCTS. BUYER ACKNOWLEDGES THAT IT ALONE HAS DETERMINED THAT THE PRODUCTS WILL SUITABLY MEET THE REQUIREMENTS OF THEIR INTENDED USE.

Omron further disclaims all warranties and responsibility of any type for claims or expenses based on infringement by the Products or otherwise of any intellectual property right.

- **Buyer Remedy**

Omron's sole obligation hereunder shall be, at Omron's election, to (i) replace (in the form originally shipped with Buyer responsible for labor charges for removal or replacement thereof) the non-complying Product, (ii) repair the non-complying Product, or (iii) repay or credit Buyer an amount equal to the purchase price of the non-complying Product; provided that in no event shall Omron be responsible for warranty, repair, indemnity or any other claims or expenses regarding the Products unless Omron's analysis confirms that the Products were properly handled, stored, installed and maintained and not subject to contamination, abuse, misuse or inappropriate modification. Return of any Products by Buyer must be approved in writing by Omron before shipment. Omron Companies shall not be liable for the suitability or unsuitability or the results from the use of Products in combination with any electrical or electronic components, circuits, system assemblies or any other materials or substances or environments. Any advice, recommendations or information given orally or in writing, are not to be construed as an amendment or addition to the above warranty.

See <http://www.omron.com/global/> or contact your Omron representative for published information.

### Limitation on Liability; Etc

---

OMRON COMPANIES SHALL NOT BE LIABLE FOR SPECIAL, INDIRECT, INCIDENTAL, OR CONSEQUENTIAL DAMAGES, LOSS OF PROFITS OR PRODUCTION OR COMMERCIAL LOSS IN ANY WAY CONNECTED WITH THE PRODUCTS, WHETHER SUCH CLAIM IS BASED IN CONTRACT, WARRANTY, NEGLIGENCE OR STRICT LIABILITY.

Further, in no event shall liability of Omron Companies exceed the individual price of the Product on which liability is asserted.

## Application Considerations

### Suitability of Use

---

Omron Companies shall not be responsible for conformity with any standards, codes or regulations which apply to the combination of the Product in the Buyer's application or use of the Product. At Buyer's request, Omron will provide applicable third party certification documents identifying ratings and limitations of use which apply to the Product. This information by itself is not sufficient for a complete determination of the suitability of the Product in combination with the end product, machine, system, or other application or use. Buyer shall be solely responsible for determining appropriateness of the particular Product with respect to Buyer's application, product or system. Buyer shall take application responsibility in all cases.

NEVER USE THE PRODUCT FOR AN APPLICATION INVOLVING SERIOUS RISK TO LIFE OR PROPERTY WITHOUT ENSURING THAT THE SYSTEM AS A WHOLE HAS BEEN DESIGNED TO ADDRESS THE RISKS, AND THAT THE OMRON PRODUCT(S) IS PROPERLY RATED AND INSTALLED FOR THE INTENDED USE WITHIN THE OVERALL EQUIPMENT OR SYSTEM.

### Programmable Products

---

Omron Companies shall not be responsible for the user's programming of a programmable Product, or any consequence thereof.

## Disclaimers

### Performance Data

---

Data presented in Omron Company websites, catalogs and other materials is provided as a guide for the user in determining suitability and does not constitute a warranty. It may represent the result of Omron's test conditions, and the user must correlate it to actual application requirements. Actual performance is subject to the Omron's Warranty and Limitations of Liability.

### Change in Specifications

---

Product specifications and accessories may be changed at any time based on improvements and other reasons. It is our practice to change part numbers when published ratings or features are changed, or when significant construction changes are made. However, some specifications of the Product may be changed without any notice. When in doubt, special part numbers may be assigned to fix or establish key specifications for your application. Please consult with your Omron's representative at any time to confirm actual specifications of purchased Product.

### Errors and Omissions

---

Information presented by Omron Companies has been checked and is believed to be accurate; however, no responsibility is assumed for clerical, typographical or proofreading errors or omissions.





# Safety Precautions

## Definition of Precautionary Information

The following notation is used in this manual to provide precautions required to ensure safe usage of a CP-series PLC. The safety precautions that are provided are extremely important to safety. Always read and heed the information provided in all safety precautions.

 <b>WARNING</b>	Indicates an imminently hazardous situation which, if not avoided, will result in death or serious injury. Additionally, there may be severe property damage.
--	---

 <b>Caution</b>	Indicates a potentially hazardous situation which, if not avoided, may result in minor or moderate injury, or property damage.
--	--

-  Precautions for Safe Use  
Indicates precautions on what to do and what not to do to ensure using the product safely.
-  Precautions for Correct Use  
Indicates precautions on what to do and what not to do to ensure proper operation and performance.

## Symbols

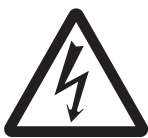

The triangle symbol indicates precautions (including warnings). The specific operation is shown in the triangle and explained in text. This example indicates a precaution for electric shock.



The circle and slash symbol indicates operations that you must not do. The specific operation is shown in the circle and explained in text.



The filled circle symbol indicates operations that you must do. The specific operation is shown in the circle and explained in text. This example shows a general precaution for something that you must do.



The triangle symbol indicates precautions (including warnings). The specific operation is shown in the triangle and explained in text. This example indicates a general precaution.



The triangle symbol indicates precautions (including warnings). The specific operation is shown in the triangle and explained in text. This example indicates a precaution for hot surfaces.

## WARNING

### **Anti-virus protection**

Install the latest commercial-quality antivirus software on the computer connected to the control system and maintain to keep the software up-to-date.



### **Security measures to prevent unauthorized access**

Take the following measures to prevent unauthorized access to our products.

- Install physical controls so that only authorized personnel can access control systems and equipment.
- Reduce connections to control systems and equipment via networks to prevent access from untrusted devices.
- Install firewalls to shut down unused communications ports and limit communications hosts and isolate control systems and equipment from the IT network.
- Use a virtual private network (VPN) for remote access to control systems and equipment.
- Adopt multifactor authentication to devices with remote access to control systems and equipment.
- Set strong passwords and change them frequently.
- Scan virus to ensure safety of USB drives or other external storages before connecting them to control systems and equipment.



### **Data input and output protection**

Validate backups and ranges to cope with unintentional modification of input/output data to control systems and equipment.

- Checking the scope of data
- Checking validity of backups and preparing data for restore in case of falsification and abnormalities
- Safety design, such as emergency shutdown and fail-soft operation in case of data tampering and abnormalities



### **Data recovery**

Backup data and keep the data up-to-date periodically to prepare for data loss.



When using an intranet environment through a global address, connecting to an unauthorized terminal such as a SCADA, HMI or to an unauthorized server may result in network security issues such as spoofing and tampering.

You must take sufficient measures such as restricting access to the terminal, using a terminal equipped with a secure function, and locking the installation area by yourself.



When constructing an intranet, communication failure may occur due to cable disconnection or the influence of unauthorized network equipment.

Take adequate measures, such as restricting physical access to network devices, by means such as locking the installation area.



When using a device equipped with the SD Memory Card function, there is a security risk that a third party may acquire, alter, or replace the files and data in the removable media by removing the removable media or unmounting the removable media.

Please take sufficient measures, such as restricting physical access to the Controller or taking appropriate management measures for removable media, by means of locking the installation area, entrance management, etc., by yourself.



**Be sure to sufficiently confirm the safety at the destination when you transfer the program or I/O memory or perform procedures to change the I/O memory.**

Devices connected to PLC outputs may incorrectly operate regardless of the operating mode of the CPU Unit.



## Caution

With an E□□(S)-type CPU Unit or with an N/NA□□(S)-type CPU Unit without a Battery, the contents of the DM Area (D) \*, Holding Area (H), the Counter Present Values (C), the status of Counter Completion Flags (C), and the status of bits in the Auxiliary Area (A) related to clock functions may be unstable when the power supply is turned ON.



\*This does not apply to areas backed up to EEPROM using the DM backup function. If the DM backup function is being used, be sure to use one of the following methods for initialization.

### 1. Clearing All Areas to All Zeros

Select the **Clear Held Memory (HR/DM/CNT) to Zero Check Box** in the **Startup Data Read Area** in the PLC Setup.

### 2. Clearing Specific Areas to All Zeros or Initializing to Specific Values

Make the settings from a ladder program.

If the data is not initialized, the unit or device may operate unexpectedly because of unstable data.

**Execute online edit only after confirming that no adverse effects will be caused by extending the cycle time.**

Otherwise, the input signals may not be readable.



The DM Area (D), Holding Area (H), Counter Completion Flags (C), and Counter Present Values (C) will be held by the Battery if a Battery is mounted in a CP1E-N/NA□□(S□)D□-□ CPU Unit. When the battery voltage is low, however, I/O memory areas that are held (including the DM, Holding, and Counter Areas) will be unstable. The unit or device may operate unexpectedly because of unstable data.



**Use the Battery Error Flag or other measures to stop outputs if external outputs are performed from a ladder program based on the contents of the DM Area or other I/O memory areas.**

**Sufficiently check safety if I/O bit status or present values are monitored in the Ladder Section Pane or present values are monitored in the Watch Pane.**

If bits are set, reset, force-set, or force-reset by inadvertently pressing a shortcut key, devices connected to PLC outputs may operate incorrectly regardless of the operating mode.



**Program so that the memory area of the start address is not exceeded when using a word address or symbol for the offset.**

For example, write the program so that processing is executed only when the indirect specification does not cause the final address to exceed the memory area by using an input comparison instruction or other instruction.

If an indirect specification causes the address to exceed the area of the start address, the system will access data in other area, and unexpected operation may occur.



**Set the temperature range according to the type of temperature sensor connected to the Unit.**

Temperature data will not be converted correctly if the temperature range does not match the sensor.



**Do not set the temperature range to any values other than those for which temperature ranges are given in the following table.**

An incorrect setting may cause operating errors.



# Precautions for Safe Use

---

Observe the following precautions when using a CP-series PLC.

## ● Handling

- To initialize the DM Area, back up the initial contents for the DM Area to backup memory using one of the following methods.
  - Set the number of words of the DM Area to be backed up starting with D0 in the *Number of CH of DM for backup* Box in the *Startup Data Read Area*.
  - Include programming to back up specified words in the DM Area to built-in EEPROM by turning ON A751.15 (DM Backup Save Start Bit).
- Check the ladder program for proper execution before actually running it on the Unit. Not checking the program may result in an unexpected operation.
- The ladder program and parameter area data in the CP1E CPU Units are backed up in the built-in EEPROM backup memory. The BKUP indicator will light on the front of the CPU Unit when the backup operation is in progress. Do not turn OFF the power supply to the CPU Unit when the BKUP indicator is lit. The data will not be backed up if power is turned OFF and a memory error will occur the next time the power supply is turned ON.
- With a CP1E CPU Unit, data memory can be backed up to the built-in EEPROM backup memory. The BKUP indicator will light on the front of the CPU Unit when backup is in progress. Do not turn OFF the power supply to the CPU Unit when the BKUP indicator is lit. If the power is turned OFF during a backup, the data will not be backed up and will not be transferred to the DM Area in RAM the next time the power supply is turned ON.
- Before replacing the battery, supply power to the CPU Unit for at least 30 minutes and then complete battery replacement within 5 minutes. Memory data may be corrupted if this precaution is not observed.
- The equipment may operate unexpectedly if inappropriate parameters are set. Even if the appropriate parameters are set, confirm that equipment will not be adversely affected before transferring the parameters to the CPU Unit.
- Before starting operation, confirm that the contents of the DM Area is correct.
- After replacing the CPU Unit, make sure that the required data for the DM Area, Holding Area, and other memory areas has been transferred to the new CPU Unit before restarting operation.
- Do not attempt to disassemble, repair, or modify any Units. Any attempt to do so may result in malfunction, fire, or electric shock.
- Confirm that no adverse effect will occur in the system before attempting any of the following. Not doing so may result in an unexpected operation.
  - Changing the operating mode of the PLC (including the setting of the startup operating mode).
  - Force-setting/force-resetting any bit in memory.
  - Changing the present value of any word or any set value in memory.

## ● External Circuits

- Always configure the external circuits to turn ON power to the PLC before turning ON power to the control system. If the PLC power supply is turned ON after the control power supply, temporary errors may result in control system signals because the output terminals on DC Output Units and other Units will momentarily turn ON when power is turned ON to the PLC.
- Fail-safe measures must be taken by the customer to ensure safety in the event that outputs from output terminals remain ON as a result of internal circuit failures, which can occur in relays, transistors, and other elements.

- If the I/O Hold Bit is turned ON, the outputs from the PLC will not be turned OFF and will maintain their previous status when the PLC is switched from RUN or MONITOR mode to PROGRAM mode. Make sure that the external loads will not produce dangerous conditions when this occurs. (When operation stops for a fatal error, including those produced with the FALS instruction, all outputs from PLC will be turned OFF and only the internal output status in the CPU Unit will be maintained.)

# Regulations and Standards

---

## Trademarks

SYSMAC is a registered trademark for Programmable Controllers made by OMRON Corporation.

CX-One is a registered trademark for Programming Software made by OMRON Corporation.

Windows is a registered trademark of Microsoft Corporation.

Other system names and product names in this document are the trademarks or registered trademarks of their respective companies.



# Related Manuals

The following manuals are related to the CP1E. Use them together with this manual.

Manual name	Cat. No.	Model numbers	Application	Contents
SYSMAC CP Series CP1E CPU Unit Software User's Manual (this manual)	W480	CP1E-E□□SD□-□ CP1E-N□□S□D□-□ CP1E-E□□D□-□ CP1E-N□□D□-□ CP1E-NA□□D□-□	To learn the software specifications of the CP1E PLCs  Use this manual together with the CP1E CPU Unit Hardware User's Manual (Cat. No. W479) and Instructions Reference Manual (Cat. No. W483).	Describes the following information for CP1E PLCs. <ul style="list-style-type: none"> <li>• CPU Unit operation</li> <li>• Internal memory</li> <li>• Programming</li> <li>• Settings</li> <li>• CPU Unit built-in functions <ul style="list-style-type: none"> <li>• Interrupts</li> <li>• High-speed counter inputs</li> <li>• Pulse outputs</li> <li>• Serial communications</li> <li>• Analog I/O function</li> <li>• Other functions</li> </ul> </li> </ul>
SYSMAC CP Series CP1E CPU Unit Hardware User's Manual	W479	CP1E-E□□SD□-□ CP1E-N□□S□D□-□ CP1E-E□□D□-□ CP1E-N□□D□-□ CP1E-NA□□D□-□	To learn the hardware specifications of the CP1E PLCs  Use this manual together with the CP1E CPU Unit Software User's Manual (Cat. No. W480) and Instructions Reference Manual (Cat. No. W483).	Describes the following information for CP1E PLCs. <ul style="list-style-type: none"> <li>• Overview and features</li> <li>• Basic system configuration</li> <li>• Part names and functions</li> <li>• Installation and settings</li> <li>• Troubleshooting</li> </ul>
SYSMAC CP Series CP1E CPU Unit Instructions Reference Manual	W483	CP1E-E□□SD□-□ CP1E-N□□S□D□-□ CP1E-E□□D□-□ CP1E-N□□D□-□ CP1E-NA□□D□-□	To learn programming instructions in detail	Describes each programming instruction in detail.  When programming, use this manual together with the CP1E CPU Unit Software User's Manual (Cat. No. W480).
CS/CJ/CP/NSJ Series Communications Commands Reference Manual	W342	CS1G/H-CPU□□H CS1G/H-CPU□□-V1 CS1D-CPU□□H CS1D-CPU□□S CS1W-SCU□□-V1 CS1W-SCB□□-V1 CJ1G/H-CPU□□H CJ1G-CPU□□P CJ1M-CPU□□ CJ1G-CPU□□ CJ1W-SCU□□-V1	To learn communications commands for CS/CJ/CP/NSJ-series Controllers in detail  <b>Note</b> This manual describes commands addressed to CPU Units. It does not cover commands addressed to other Units or ports (e.g., serial communications ports on CPU Units, communications ports on Serial Communications Units/Boards, and other Communications Units).	Describes <ol style="list-style-type: none"> <li>1) C-mode commands and</li> <li>2) FINS commands in detail.</li> </ol> Read this manual for details on C-mode and FINS commands addressed to CPU Units.
SYSMAC CP Series CP1L/CP1E CPU Unit Introduction Manual	W461	CP1L-L10D□-□ CP1L-L14D□-□ CP1L-L20D□-□ CP1L-M30D□-□ CP1L-M40D□-□ CP1L-M60D□-□ CP1E-E□□D□-□ CP1E-N□□D□-□ CP1E-NA□□D□-□	To learn the basic setup methods of the CP1L/CP1E PLCs	Describes the following information for CP1L/CP1E PLCs. <ul style="list-style-type: none"> <li>• Basic configuration and component names</li> <li>• Mounting and wiring</li> <li>• Programming, data transfer, and debugging using the CX-Programmer</li> <li>• Application program examples</li> </ul>
CX-Simulator Operation Manual	W366	CXONE-AL□□C-V4/ AL□□D-V4	Operating procedures for CX-Simulator Simulation Support Software for Windows computers Using simulation in the CX-Programmer with CX-Programmer	Describes the operating procedures for the CX-Simulator.



# 1

## Overview

This section gives an overview of the CP1E and describes its procedures.

---

<b>1-1 CP1E Overview</b> .....	<b>1-2</b>
1-1-1 Overview of Features .....	1-2
<b>1-2 Basic Operating Procedure</b> .....	<b>1-4</b>
<b>1-3 Difference between E/N/NA□□-type and E/N□□S-type</b> .....	<b>1-5</b>

# 1-1 CP1E Overview

## 1-1-1 Overview of Features

The SYSMAC CP1E Programmable Controller is a package-type PLC made by OMRON that is designed for easy application. The CP1E includes E□□(S)-type CPU Units (basic models) for standard control operations using basic, movement, arithmetic, and comparison instructions, and N/NA□□(□)-type CPU Units (application models) that supports connections to Programmable Terminals, Inverters, and Servo Drives.

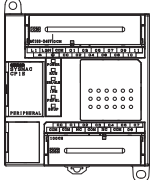
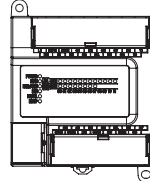
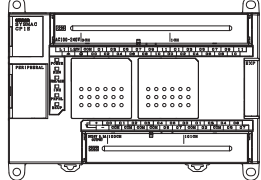
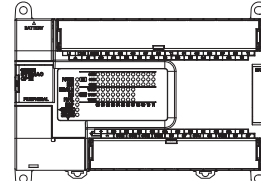
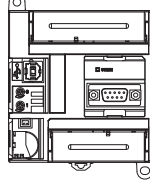
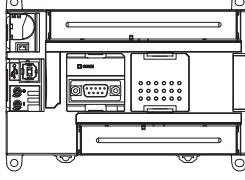
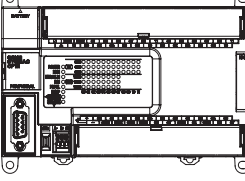
	Basic Models		CP1E Application Models		
	E□□(S)-type CPU Units		N□□(□)-type CPU Units		NA□□-type CPU Units
	CPU with 10, 14 or 20 I/O Points	CPU Unit with 30, 40 or 60 I/O Points	CPU with 14 or 20 I/O Points	CPU Unit with 30, 40 or 60 I/O Points	CPU Unit with 20 I/O Points
<b>Appearance</b>	E□□-type  E□□S-type 	E□□-type  E□□S-type 	N□□-type 	N/NA□□-type  N□□S(1)-type 	
<b>I/O points</b>	E□□ 10/14/20/30/40 E□□S 14/20/30/40/60		N□□ 14/20/30/40/60 N□□S(1) 30/40/60		20
<b>Program capacity</b>	2K steps		8K steps		
<b>DM Area capacity</b>	2K words Of these 1,500 words can be written to the built-in EEPROM.		8K words Of these 7,000 words can be written to the built-in EEPROM.		
<b>Mounting Expansion I/O Units and Expansion Units</b>	Not possible.	3 Units maximum	Not possible.	3 Units maximum	
<b>Model with transistor outputs</b>	Available (CPU Unit with 10 I/O points only)		Available		
<b>Pulse outputs</b>	Not supported.		Supported (Model with transistor outputs only)		
<b>Built-in serial communications port</b>	Not provided.		RS-232C port provided RS-485 port provided (N□□S1-type only)		
<b>Built-in analog</b>	Not available.		Not available.		Available
<b>Option Board</b>	Not supported.		Not supported.	N/NA□□-type: Supported (for one port) N□□S(1)-type: Not Supported	
<b>Connection port for Programming Device</b>	USB port		USB port		
<b>Clock</b>	Not provided.		Provided		
<b>Using a Battery</b>	Cannot be used.		Can be used (sold separately).		
<b>Backup time of built-in capacitor</b>	50 hours at 25°C		40 hours at 25°C		
<b>Battery-free operation</b>	Always battery-free operation. Only data in the built-in EEPROM will be retained if power is interrupted for longer than 50 hours.		Battery-free operation if no battery is attached. Only data in the built-in EEPROM will be retained if power is interrupted for longer than 40 hours.		



### **Precautions for Correct Use**

---

For CP1E CPU Units, the following I/O memory area will be unstable after a power interruption.

- DM Area (D) (excluding words backed up to the EEPROM using the DM function)
- Holding Area (H)
- Counter Present Values and Completion Flags (C)
- Auxiliary Area related to clock functions(A)

Mount the CP1W-BAT01 Battery (sold separately) to an N/NA□□(S)-type CPU Unit if data in the above areas need to be retained after a power interruption. A Battery cannot be mounted to an E□□(S)-type CPU Unit.

---

# 1-2 Basic Operating Procedure

In general, use the following procedure.

## 1. Setting Devices and Hardware

Connect the CPU Unit, Expansion I/O Units, and Expansion Units.  
Set the DIP switches on the Option Board and Expansion Units as required.

Refer to *Section 3 Part Names and Functions* and *Section 5 Installation and Wiring* in the *CP1E CPU Unit Hardware User's Manual* (Cat. No. W479).

## 2. Wiring

Wire the power supply, I/O, and communications.

Refer to *Section 5 Installation and Wiring* in the *CP1E CPU Unit Hardware User's Manual* (Cat. No. W479).

## 3. Connecting Online to the PLC

Connect the personal computer online to the PLC.

Refer to *Section 4 Programming Device* in the *CP1E CPU Unit Hardware User's Manual* (Cat. No. W479).

## 4. I/O Allocations

Allocations for built-in I/O on the CPU Unit are predetermined and memory is allocated automatically to Expansion I/O Units and Expansion Units, so the user does not have to do anything.

Refer to *Section 6 I/O Allocation* in the *CP1E CPU Unit Software User's Manual* (Cat. No. W480).

## 5. Software Setup

Make the PLC software settings.

With a CP1E CPU Unit, all you have to do is set the PLC Setup.

When using an E□□(S)-type CPU Unit or when using an N/NA□□(S)-type CPU Unit without a Battery, be sure to consider selecting the *Clear retained memory area (HR/DM/CNT)* Check Box in the *Startup Data Read Area* in the PLC Settings.

Refer to *3-2-4 Initializing I/O Memory at Startup*, *Section 7 PLC Setup* in the *CP1E CPU Unit Software User's Manual* (Cat. No. W480).

## 6. Writing the Programs

Write the programs using the CX-Programmer.

Refer to *Section 4 Programming Concepts* in the *CP1E CPU Unit Software User's Manual* (Cat. No. W480).

## 7. Checking Operation

Check the I/O wiring and the Auxiliary Area settings, and perform trial operation.

The CX-Programmer can be used for monitoring and debugging.

Refer to *Section 8 Overview and Allocation of Built-in Functions*.

## 8. Basic Program Operation

Set the operating mode to RUN mode to start operation.

# 1-3 Difference between E/N/NA□□-type and E/N□□S(1)-type

The differences among functions other than appearances of E/N/NA□□-type CPU Units and E/N□□S(1)-type CPU Units are as follows.

Refer to A-1 Dimensions for the dimensions.

## E-type CPU Units

### ● Difference in Characteristics and Functions

Function	E□□-type	E□□S-type
Analog adjusters	2 adjusters (Setting range: 0 to 255)	None The analog adjuster PV in A642/A643 is fixed on 0000.

### ● Product Lineup

	E□□ CPU Unit				E□□S CPU Unit			
	Relay outputs		Transistor outputs (sinking/sourcing)		Relay Outputs		Transistor outputs (sinking/sourcing)	
	AC	DC	AC	DC	AC	DC	AC	DC
10 I/O points	○	○	○	○	–	–	–	–
14 I/O points	○	–	–	–	○	–	–	–
20 I/O points	○	–	–	–	○	–	–	–
30 I/O points	○	–	–	–	○	–	–	–
40 I/O points	○	–	–	–	○	–	–	–
60 I/O points	–	–	–	–	○	–	–	–

## N-type CPU Units

### ● Difference in Characteristics and Functions

Function	N/NA□□-type	N□□S(1) -type																																																																																								
Analog adjusters	2 adjusters (Setting range: 0 to 255)	None The analog adjuster PV in A642/A643 is fixed on 0000.																																																																																								
Built-in RS-232C port	6 signals are supported: SD, RD, RS, CS, DR and ER. <table border="1"> <thead> <tr> <th>Pin</th> <th>Abbr.</th> <th>Signal</th> <th>Signal direction</th> </tr> </thead> <tbody> <tr><td>1</td><td>FG</td><td>Frame ground</td><td>–</td></tr> <tr><td>2</td><td>SD(TXD)</td><td>Send data</td><td>Outputs</td></tr> <tr><td>3</td><td>RD(RXD)</td><td>Receive data</td><td>Inputs</td></tr> <tr><td>4</td><td>RS(RTS)</td><td>Request to send</td><td>Outputs</td></tr> <tr><td>5</td><td>CS(CTS)</td><td>Clear to send</td><td>Inputs</td></tr> <tr><td>6</td><td>5V</td><td>Power</td><td>–</td></tr> <tr><td>7</td><td>DR(DSR)</td><td>Data set ready</td><td>Inputs</td></tr> <tr><td>8</td><td>ER(DTR)</td><td>Data terminal ready</td><td>Outputs</td></tr> <tr><td>9</td><td>SG(0V)</td><td>Signal ground</td><td>–</td></tr> <tr><td>Connector hood</td><td>FG</td><td>Frame ground</td><td>–</td></tr> </tbody> </table>	Pin	Abbr.	Signal	Signal direction	1	FG	Frame ground	–	2	SD(TXD)	Send data	Outputs	3	RD(RXD)	Receive data	Inputs	4	RS(RTS)	Request to send	Outputs	5	CS(CTS)	Clear to send	Inputs	6	5V	Power	–	7	DR(DSR)	Data set ready	Inputs	8	ER(DTR)	Data terminal ready	Outputs	9	SG(0V)	Signal ground	–	Connector hood	FG	Frame ground	–	4 signals are supported: SD, RD, RS and CS. DR (pin 7) and ER (pin 8) are not supported. <table border="1"> <thead> <tr> <th>Pin</th> <th>Abbr.</th> <th>Signal</th> <th>Signal direction</th> </tr> </thead> <tbody> <tr><td>1</td><td>FG</td><td>Frame ground</td><td>–</td></tr> <tr><td>2</td><td>SD(TXD)</td><td>Send data</td><td>Outputs</td></tr> <tr><td>3</td><td>RD(RXD)</td><td>Receive data</td><td>Inputs</td></tr> <tr><td>4</td><td>RS(RTS)</td><td>Request to send</td><td>Outputs</td></tr> <tr><td>5</td><td>CS(CTS)</td><td>Clear to send</td><td>Inputs</td></tr> <tr><td>6</td><td>5V</td><td>Power</td><td>–</td></tr> <tr><td>7</td><td>NC</td><td>–</td><td>–</td></tr> <tr><td>8</td><td>NC</td><td>–</td><td>–</td></tr> <tr><td>9</td><td>SG(0V)</td><td>Signal ground</td><td>–</td></tr> <tr><td>Connector hood</td><td>FG</td><td>Frame ground</td><td>–</td></tr> </tbody> </table>	Pin	Abbr.	Signal	Signal direction	1	FG	Frame ground	–	2	SD(TXD)	Send data	Outputs	3	RD(RXD)	Receive data	Inputs	4	RS(RTS)	Request to send	Outputs	5	CS(CTS)	Clear to send	Inputs	6	5V	Power	–	7	NC	–	–	8	NC	–	–	9	SG(0V)	Signal ground	–	Connector hood	FG	Frame ground	–
Pin	Abbr.	Signal	Signal direction																																																																																							
1	FG	Frame ground	–																																																																																							
2	SD(TXD)	Send data	Outputs																																																																																							
3	RD(RXD)	Receive data	Inputs																																																																																							
4	RS(RTS)	Request to send	Outputs																																																																																							
5	CS(CTS)	Clear to send	Inputs																																																																																							
6	5V	Power	–																																																																																							
7	DR(DSR)	Data set ready	Inputs																																																																																							
8	ER(DTR)	Data terminal ready	Outputs																																																																																							
9	SG(0V)	Signal ground	–																																																																																							
Connector hood	FG	Frame ground	–																																																																																							
Pin	Abbr.	Signal	Signal direction																																																																																							
1	FG	Frame ground	–																																																																																							
2	SD(TXD)	Send data	Outputs																																																																																							
3	RD(RXD)	Receive data	Inputs																																																																																							
4	RS(RTS)	Request to send	Outputs																																																																																							
5	CS(CTS)	Clear to send	Inputs																																																																																							
6	5V	Power	–																																																																																							
7	NC	–	–																																																																																							
8	NC	–	–																																																																																							
9	SG(0V)	Signal ground	–																																																																																							
Connector hood	FG	Frame ground	–																																																																																							
Option board	1 port (N30/40/60, NA20 CPU Unit only) The following option boards can be mounted. RS-232C Option Board CP1W-CIF01 RS-422A/485 Option Board CP1W-CIF11/12 Ethernet Option Board CP1W-CIF41 Analog Option Board CP1W-ADB21/DAB21V/MAB221	Cannot be mounted There is no slot for an option board.																																																																																								
Built-in RS-485 port	None	1 port (N30/40/60S1 CPU Unit only) With 2-wire connections, it can only communicate in half duplex. Terminating resistance ON/OFF can be set by DIP switch.																																																																																								
COM allocation (Transistor outputs only)	CIO 100.00 and CIO 100.01 correspond with different common terminals. <table border="1"> <tr><td>NC</td><td>00</td><td>01</td><td>02</td></tr> <tr><td>NC</td><td>COM</td><td>COM</td><td>COM</td></tr> <tr><td></td><td></td><td></td><td>03</td></tr> </table> CIO 100.00 and CIO 100.01 are different COM.	NC	00	01	02	NC	COM	COM	COM				03	CIO 100.00 and CIO 100.01 correspond with the same common terminal. <table border="1"> <tr><td>V+</td><td>00</td><td>01</td><td>02</td></tr> <tr><td>V-</td><td>COM(V-)</td><td>COM</td><td>03</td></tr> </table> CIO 100.00 and CIO 100.01 are the same COM.	V+	00	01	02	V-	COM(V-)	COM	03																																																																				
NC	00	01	02																																																																																							
NC	COM	COM	COM																																																																																							
			03																																																																																							
V+	00	01	02																																																																																							
V-	COM(V-)	COM	03																																																																																							

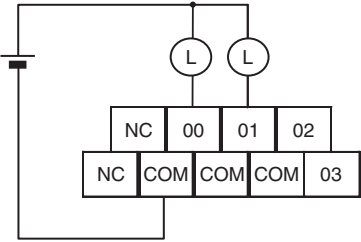
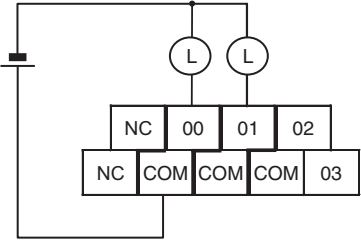
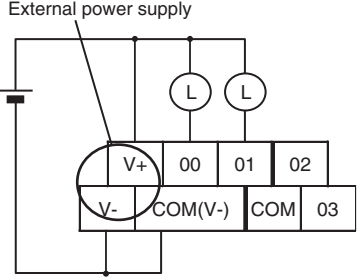
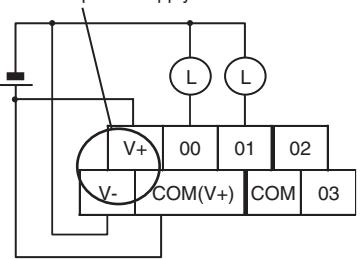

Function	N/NA□□-type	N□□S(1) -type
Power supply for transistor outputs (Transistor outputs only)	<p>Not needed Do not connect an external power supply.</p> <p><b>Wiring Example</b> Sinking outputs</p>  <p>Sourcing outputs</p> 	<p>Needed It is necessary to connect a DC24V external power supply when using terminals 00 and 01 on terminal block CIO 100. Do not connect the external power supply to the terminals except 00 and 01 on terminal block CIO 100.</p> <p><b>Wiring Example</b> Sinking outputs</p>  <p>Sourcing outputs</p> 

● Product Lineup

	N□□ CPU Unit RS-232C+1 option slot(*)				N□□S CPU Unit Built-in RS-232C				N□□S1 CPU Unit Built-in RS-232C+RS-485				
	Relay outputs		Transistor outputs (sinking/sourcing)		Relay Outputs		Transistor outputs (sinking/sourcing)		Relay Outputs		Transistor outputs (sinking/sourcing)		
	AC	DC	AC	DC	AC	DC	AC	DC	AC	DC	AC	DC	
10 I/O points		–	–	–	–	–	–	–	–	–	–	–	–
14 I/O points		○	○	○	–	–	–	–	–	–	–	–	–
20 I/O points		○	○	○	–	–	–	–	–	–	–	–	–
30 I/O points		○	○	○	○	–	–	○	○	–	–	○	○
40 I/O points		○	○	○	○	–	–	○	○	–	–	○	○
60 I/O points		○	○	○	○	–	–	○	○	–	–	○	○

\* Only N30/40/60 has option slot.



# 2

## Internal Memory in the CPU Unit

This section describes the types of internal memory in a CP1E CPU Unit and the data that is stored.

---

<b>2-1</b>	<b>Internal Memory in the CPU Unit</b> .....	<b>2-2</b>
2-1-1	CPU Unit Memory Backup Structure .....	2-2
2-1-2	Memory Areas and Stored Data .....	2-3
2-1-3	Transferring Data from a Programming Device .....	2-4
2-1-4	Backup .....	2-4

## 2-1 Internal Memory in the CPU Unit

### 2-1-1 CPU Unit Memory Backup Structure

The internal memory in the CPU Unit consists of built-in RAM and built-in EEPROM. The built-in RAM is used as execution memory and the built-in EEPROM is used as backup memory.

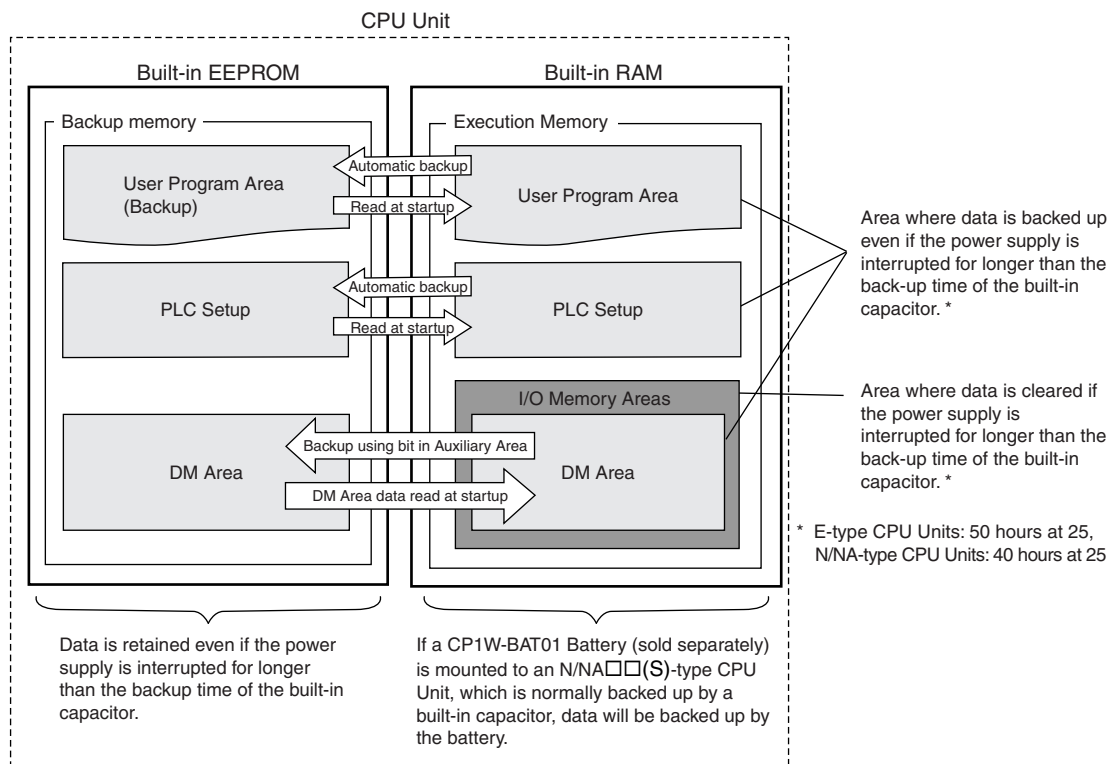

### Built-in RAM

The built-in RAM is the execution memory for the CPU Unit.

The user programs, PLC Setup, and I/O memory are stored in the built-in RAM.

The data is unstable when the power is interrupted.

If a CP1W-BAT01 Battery (sold separately) is mounted to an N/NA□□(S)-type CPU Unit, the data is backed up by the Battery.

The user programs and parameters are backed up to the built-in EEPROM, so they are not lost.

### Built-in EEPROM

The built-in EEPROM is the backup memory for user programs, PLC Setup, and Data Memory backed up using control bits in the Auxiliary Area.

Data is retained even if the power supply is interrupted. Only the Data Memory Area words that have been backed up using the Auxiliary Area control bits are backed up (Refer to 16-3 DM Backup Function). All data in all other words and areas is not backed up.

## ! Caution

With an E□□(S)-type CPU Unit or with an N/NA□□(S)-type CPU Unit without a Battery, the contents of the DM Area (D) \*, Holding Area (H), the Counter Present Values (C), the status of Counter Completion Flags (C), and the status of bits in the Auxiliary Area (A) related to clock functions may be unstable when the power supply is turned ON.



\*This does not apply to areas backed up to EEPROM using the DM backup function. If the DM backup function is being used, be sure to use one of the following methods for initialization.

### 1. Clearing All Areas to All Zeros

Select the **Clear retained memory area (HR/DM/CNT) to Zero Check Box** in the **Startup Data Read Area** in the PLC Setup.

### 2. Clearing Specific Areas to All Zeros or Initializing to Specific Values

Make the settings from a ladder program.

If the data is not initialized, the unit or device may operate unexpectedly because of unstable data.

## 2-1-2 Memory Areas and Stored Data

The following table lists the CPU Unit memory areas and the data stored in each area.

Memory area and stored data	Details	Built-in RAM	Built-in EEPROM
User Program Area		Stored	Stored
User Program	The User Program Area stores the object code for executing the user program that was created using the CX-Programmer.		
Symbol Table	The symbol table contains symbols created using the CX-Programmer (symbol names, addresses, and I/O comments).		
Comments	Comments are created using the CX-Programmer and include annotations and row comments.		
Program Index	The program index provides information on program sections created using the CX-Programmer, as well as program comments.		
Parameter Area		Stored	Stored
Setting PLC Setup	Various initial settings are made in the PLC Setup using software switches. Refer to <i>Section 7 PLC Setup</i> .		
I/O Memory Areas	The I/O Memory Areas are used for reading and writing from the user programs. It is partitioned into the following regions according to purpose. <ul style="list-style-type: none"> <li>Regions where data is cleared when power to the CPU Unit is reset, and regions where data is retained.</li> <li>Regions where data are exchanged with other Units, and regions that are used internally.</li> </ul>	Stored	Not stored
	DM Area words backed up to backup memory (built-in EEPROM) using control bits in the Auxiliary Area.	Stored	Stored

### 2-1-3 Transferring Data from a Programming Device

Data that has been created using the CX-Programmer is transferred to the internal memory in the CPU Unit as shown in the following diagram.

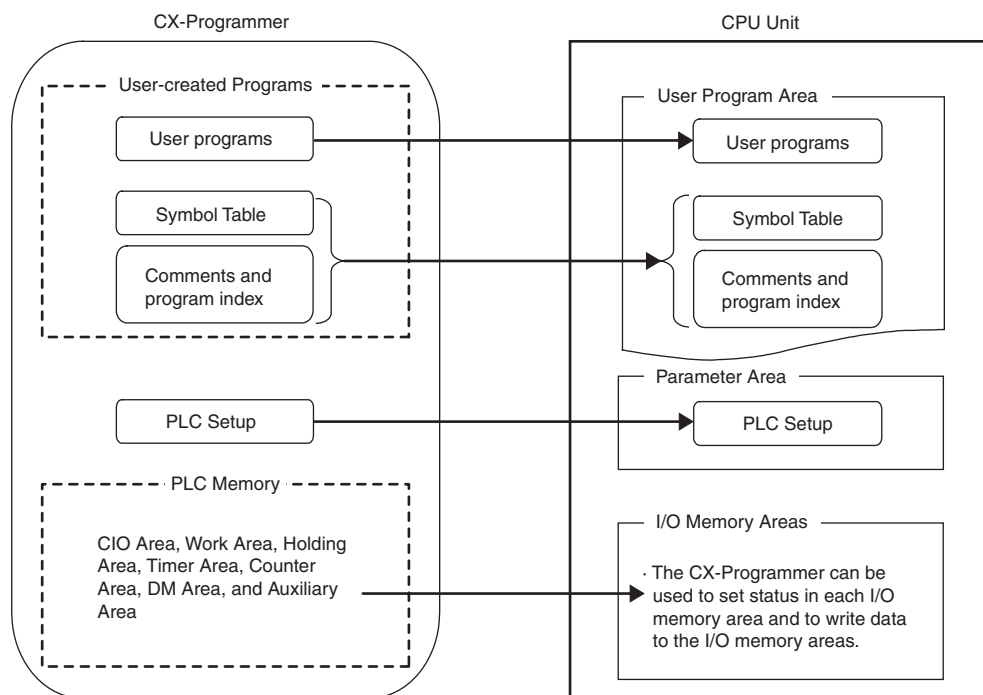

### 2-1-4 Backup

The CPU Unit will access the backup memory in the following process.

- The program or PLC Setup are transferred from the CX-Programmer.
- The program is changed during online editing.
- DM backup is operated by the Auxiliary Area.

During these processes, BKUP LED will light, indicating that the CX-Programmer is being backed up.

There are the following limitations during backup.

- The operation mode cannot be switched from PROGRAM mode to MONITOR/RUN mode.
- If the power is interrupted when the program or PLC Setup are being backed up, memory error may occur the next time power is turned ON.
- If the power is interrupted when the DM area is being backed up, the reading of backed up DM area will fail the next time power is turned ON.

# 3

## CPU Unit Operation

This section describes the operation of the CP1E CPU Unit. Make sure that you understand the contents of this section completely before writing ladder programs.

---

<b>3-1 CPU Unit Operation</b> .....	<b>3-2</b>
3-1-1 Overview of CPU Unit Operation .....	3-2
3-1-2 CPU Unit Operating Modes .....	3-3
<b>3-2 Backing Up Memory</b> .....	<b>3-5</b>
3-2-1 CPU Unit Memory Configuration .....	3-5
3-2-2 Backing Up Ladder Programs and PLC Setup .....	3-6
3-2-3 I/O Memory Backup .....	3-6
3-2-4 Initializing I/O Memory at Startup .....	3-8

## 3-1 CPU Unit Operation

This section gives an overview of the CPU Unit operation, describes the operating modes, and explains how the Unit operates when there is a power interruption.

### 3-1-1 Overview of CPU Unit Operation

The CPU Unit reads and writes data to the internal I/O memory areas while executing user ladder programs by executing the instructions in order one at a time from the start to the end.

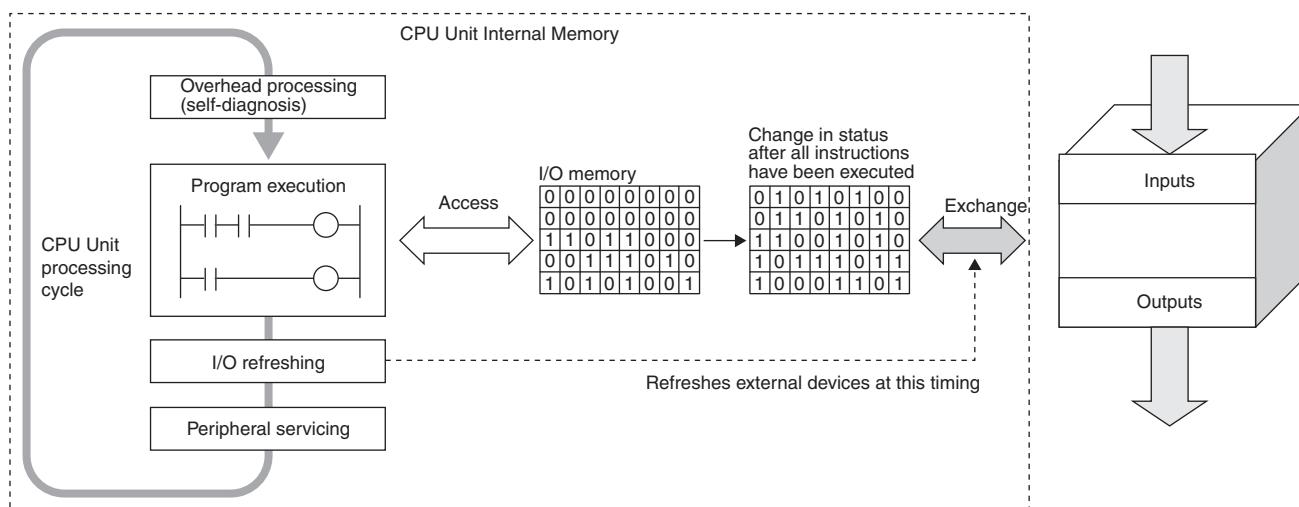

#### Overhead Processing (Self-diagnosis)

Self-diagnosis, such as an I/O bus check, is performed.

#### Ladder Program Execution

Instructions are executed from the beginning of the program and I/O memory is refreshed.

#### I/O Refresh

Data to and from external devices, such as sensors and switches, directly connected to the built-in I/O terminals and expansion I/O terminals, is exchanged with data in the I/O memory of the PLC. This process of data exchange is called the I/O refresh.

#### Peripheral Servicing

Peripheral servicing is used to communicate with devices connected to the communications port or for exchanging data with the CX-Programmer.

#### Cycle Time

The cycle time is the time between one I/O refresh and the next. The cycle time can be determined beforehand for SYSMAC PLCs.





### Additional Information

The average cycle time during operation will be displayed in the status bar on the bottom right of the Ladder Program Window on the CX-Programmer.

## I/O Memory

These are the PLC memory areas that are accessed by the ladder programs. SYSMAC PLCs refer to these areas as the I/O memory. It can be accessed by specifying instruction operands. There are words in the I/O memory area where data is cleared and words where data is retained when recovering from a power interruption. There are also words that can be set to be cleared or retained. Refer to *Section 5 I/O Memory*.

## 3-1-2 CPU Unit Operating Modes

### Overview of Operating Modes

CPU Units have the following three operating modes.

- |               |   |
|---------------|---|
| PROGRAM mode: | The programs are not executed in PROGRAM mode. This mode is used for the initial settings in PLC Setup, transferring ladder programs, checking ladder programs, and making preparations for executing ladder programs such as force-setting/resetting bits. |
| MONITOR mode: | In this mode, it is possible to perform online editing, force-set/reset bits, and change I/O memory present values while the ladder programs are being executed. Adjustments during trial operation are also made in this mode.                             |
| RUN mode:     | This is the mode in which the ladder program is executed. Some operations are disabled during this mode. It is the startup mode at initial value when the CPU Unit is turned ON.  |

### Changing the Operating Mode

The operating mode can be changed from the CX-Programmer.

#### ● Changing the Startup Mode

The default operating mode when the CPU Unit is turned ON is RUN mode.

To change the startup mode to PROGRAM or MONITOR mode, set the desired mode in Startup Setting in PLC Setup from the CX-Programmer.

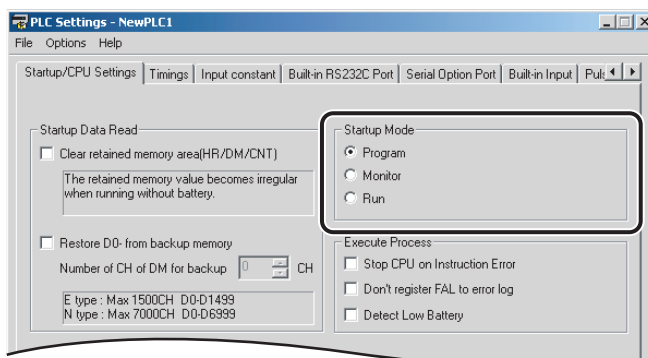

### ● Changing the Operating Mode after Startup

Use one of the following procedures.

- Select PROGRAM, MONITOR, or RUN from the Startup Mode Menu.
- Right-click the PLC in the project tree, and then select PROGRAM, MONITOR, or RUN from the Startup Mode Menu.

## Operating Modes and Operation

The following table lists status and operations for each mode.

Operating mode		PROGRAM	MONITOR	RUN	
Ladder program execution		Stopped	Executed	Executed	
I/O refresh		Executed	Executed	Executed	
External I/O status		OFF after changing to PROGRAM mode but can be turned ON from the CX-Programmer afterward.	Controlled by the ladder programs.	Controlled by the ladder programs.	
I/O memory	Non-retained memory	Cleared	Controlled by the ladder programs.	Controlled by the ladder programs.	
	Retained memory	Retained			
CX-Programmer operations	I/O memory monitoring		Yes	Yes	Yes
	Ladder program monitoring		Yes	Yes	Yes
	Ladder program transfer	From CPU Unit	Yes	Yes	Yes
		To CPU Unit	Yes	No	No
	Checking programs		Yes	No	No
	Setting the PLC Setup		Yes	No	No
	Changing ladder programs		Yes	Yes	No
	Forced-set/reset operations		Yes	Yes	No
	Changing timer/counter PV		Yes	Yes	No
	Change I/O memory PV		Yes	Yes	No

## The Retaining of I/O Memory When Changing the Operating Mode

Mode changes	Non-retained areas	Retained areas
	<ul style="list-style-type: none"> <li>• I/O bits</li> <li>• Serial PLC Link Words</li> <li>• Work bits</li> <li>• Timer PV/Completion Flags</li> <li>• Data Registers (Auxiliary Area bits/words are retained or not retained depending on the address.)</li> </ul>	<ul style="list-style-type: none"> <li>• Holding Area</li> <li>• DM Area</li> <li>• Counter PV and Completion Flags (Auxiliary Area bits/words are retained or not retained depending on the address.)</li> </ul>
<b>RUN or MONITOR to PROGRAM</b>	Cleared*	Retained
<b>PROGRAM to RUN or MONITOR</b>	Cleared*	Retained
<b>RUN to MONITOR or MONITOR to RUN</b>	Retained*	Retained

\* The data is cleared when the IOM Hold Bit is OFF. The outputs from the Output Units will be turned OFF when a fatal error is occurred, regardless of the status of the IOM Hold Bit, and the status of the output bits in CPU Unit's I/O memory is retained.

Refer to *Section 5 I/O Memory* for details on the I/O memory.

## 3-2 Backing Up Memory

This section describes backing up the CP1E CPU Unit memory areas.

### 3-2-1 CPU Unit Memory Configuration

Data backup to the CP1E CPU Unit's built-in RAM memory describes as below.

- **Ladder programs and PLC Setup**

Automatically backed up to the built-in EEPROM whenever changed.

- **DM Area in the I/O memory**

Data in specified words of the DM Area can be backed up to the built-in EEPROM by using bits in the Auxiliary Area. Other words are not backed up.

- **Other areas in the I/O memory (including Holding Area data, Counter PVs, and Counter Completion Flags)**

Not backed up to the built-in EEPROM.

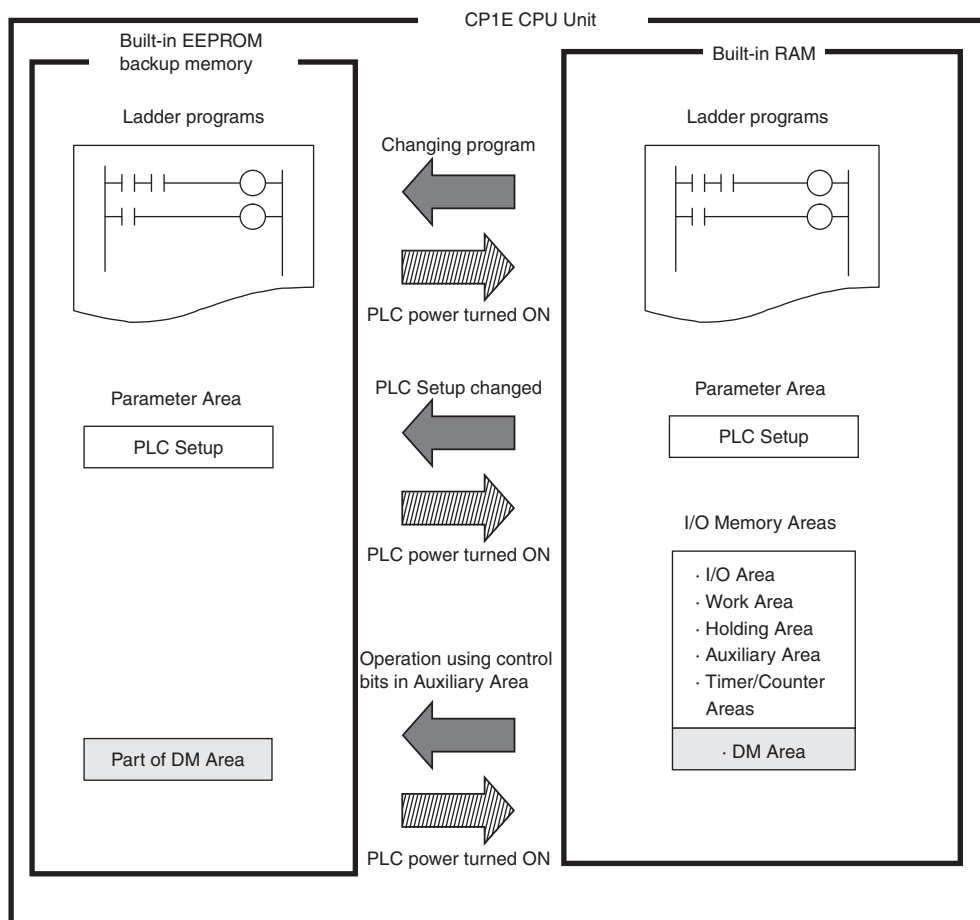

### 3-2-2 Backing Up Ladder Programs and PLC Setup

Ladder programs and the PLC Setup are automatically backed up to and restored from the built-in EEPROM backup memory.

#### ● Backing Up Memory

Ladder programs and PLC Setup are backed up to the built-in EEPROM backup memory by transferring them from the CX-Programmer or writing them using online editing.

#### ● Restoring Memory

Ladder programs and PLC Setup are automatically transferred from the built-in EEPROM backup memory to the RAM memory when power is turned ON again or at startup.



#### Precautions for Safe Use

The BKUP indicator on the front of the CPU Unit turns ON when data is being written to the built-in EEPROM backup memory. Never turn OFF the power supply to the CPU Unit when the BKUP indicator is lit.

### 3-2-3 I/O Memory Backup

I/O memory is backed up to the built-in EEPROM backup memory only when a bit in the Auxiliary Area is turned ON to back up specified words in the DM Area.

Area	Backup to built-in EEPROM backup memory	Status at startup	
		N/NA□□(S)-type CPU Unit with no Battery mounted or E□□(S)-type CPU Unit	N/NA□□(S)-type CPU Unit with Battery mounted
CIO Area	Not backed up.	Cleared to all zeros.	
Work Area (W)			
Timer Area (T)			
Holding Area (H)		Unstable when the power supply is OFF for longer than the I/O memory backup time.*	The values immediately before power interruption are retained.
Counter Area (C)			
Auxiliary Area (A)		Initialized (For N/NA□□(S)-type CPU Units, status of bits related to clock functions is unstable when the power supply is OFF for longer than the I/O memory backup time.*)	Initialized (For N/NA□□(S)-type CPU Units, status of bits related to clock functions are retained at their status immediately before power interruption.)
DM Area (D)	Number of words starting from D0 set in the Number of CH of DM for backup Box in the Startup Data Read Area in the PLC Settings.	The specified number of words starting from D0 is backed up by turning ON A751.15 (DM Backup Save Start Bit).	The specified number of words starting from D0 is restored from the built-in EEPROM backup memory if the Restore D0- from backup memory Check Box is selected in the Startup Data Read Area in the PLC Settings.
	Ranges not given above.	Not backed up.	Unstable when the power supply is OFF for longer than the I/O memory backup time.

\* The values will be cleared to all zeros at startup if the Clear retained memory area (HR/DM/CNT) Check Box is selected in the PLC Settings.

## I/O Memory Backup Time

The built-in capacitor's backup time for I/O memory during a power interruption is listed below for E□□(S)-type CPU Units and N/NA□□(S)-type CPU Units.

E□□(S)-type CPU Units: 50 hours at 25°C

N/NA□□(S)-type CPU Units (without a battery): 40 hours at 25°C

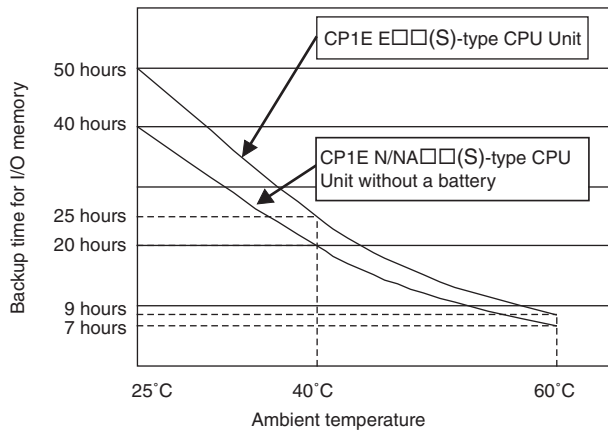

The following areas are unstable when power is interrupted for longer than the I/O memory backup times given above.

- DM Area (D) (excluding words backed up to the EEPROM using the DM backup function)
- Holding Area (H)
- Counter PVs and Completion Flags (C)
- Auxiliary Area related to clock function (A)



### Additional Information

Words in the Auxiliary Area related to clock function are unstable. Others are cleared to default values.

Words	Name	Power interruption time		CPU Unit	
		Less than I/O memory backup time	Longer than I/O memory backup time	E□□(S)-type CPU Unit	N/NA□□(S)-type CPU Unit
A100 to A199	Error Log Area	Retained	Unstable	Supported	Supported
A300	Error Log Pointer			Supported	
A351 to A354	Clock Area			Not supported.	
A510 to A511	Startup Time			Not supported.	
A512 to A513	Power Interruption Time			Not supported.	
A514	Number of Power Interruptions			Supported	
A515 to A517	Operation Start Time			Not supported.	
A518 to A520	Operation End Time			Not supported.	
A720 to A749	Power ON Clock Data 1 to 10			Not supported.	



### Precautions for Correct Use

Use an N/NA□□(S)-type CPU Unit with a Battery mounted if it is necessary to retain the contents of the DM Area (D) and Holding Area (A), the Counter Present Values (C), the status of Counter Completion Flags (C), and the status of bits in the Auxiliary Area (A) related to clock functions when the power supply is turned ON after the power has been OFF for a period of time. These contents and status cannot be retained with an E□□(S)-type CPU Unit.

### 3-2-4 Initializing I/O Memory at Startup

For E□□(S)-type or N/NA□□(S)-type (without a battery) CPU Units, the held areas in I/O memory (i.e., Holding Area, Counter Present Values, Counter Completion Flags, and DM Area) may be unstable when the power supply is turned ON. Therefore, use one of the following ways to clear these areas.

- **Clearing All Held Areas to Zero at Startup**

Select the Clear retained memory area (HR/DM/CNT) Check Box in the PLC Settings.

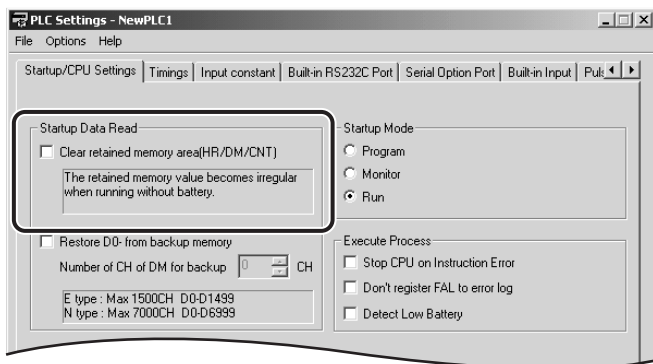

**Note** If the Restore D0- from backup memory Check Box is selected, only the specified words in the DM Area will be restored from the built-in EEPROM backup memory when the power supply is turned ON.

- **Initializing Specific Held Areas at Startup**

Write the following type of ladder programming.

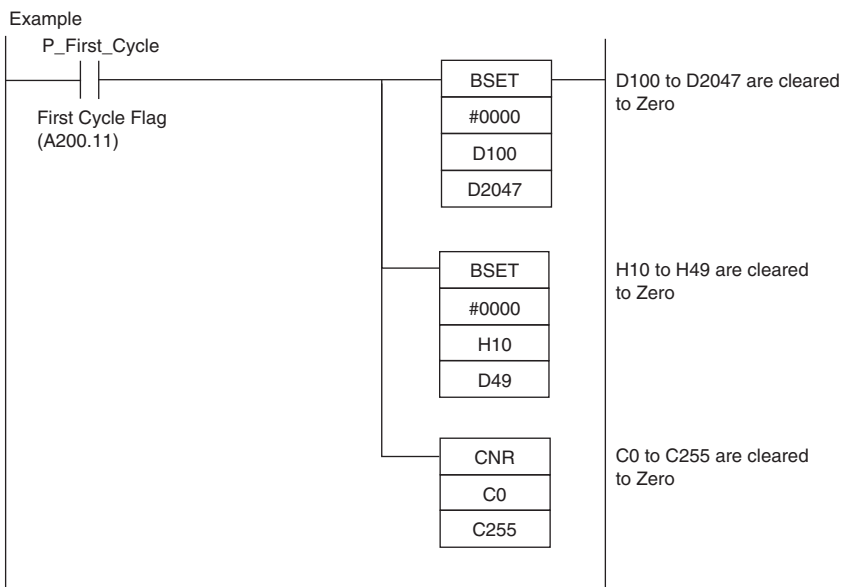

# 4

## Understanding Programming

This section provides basic information on ladder programming for CP1E CPU Units.

---

<b>4-1</b>	<b>Programming</b> .....	<b>4-2</b>
4-1-1	User Programs .....	4-2
4-1-2	Program Capacity .....	4-3
4-1-3	Basics of Programming .....	4-3
<b>4-2</b>	<b>Tasks, Sections, and Symbols</b> .....	<b>4-6</b>
4-2-1	Overview of Tasks .....	4-6
4-2-2	Overview of Sections .....	4-6
4-2-3	Overview of Symbols .....	4-6
<b>4-3</b>	<b>Programming Instructions</b> .....	<b>4-8</b>
4-3-1	Basic Understanding of Instructions .....	4-8
4-3-2	Operands .....	4-9
4-3-3	Instruction Variations .....	4-10
4-3-4	Execution Conditions .....	4-10
4-3-5	Specifying Data in Operands .....	4-12
4-3-6	Data Formats .....	4-13
4-3-7	I/O Refresh Timing .....	4-15
<b>4-4</b>	<b>Constants</b> .....	<b>4-16</b>
<b>4-5</b>	<b>Specifying Offsets for Addresses</b> .....	<b>4-19</b>
4-5-1	Overview .....	4-19
4-5-2	Application Examples for Address Offsets .....	4-21
<b>4-6</b>	<b>Ladder Programming Precautions</b> .....	<b>4-22</b>
4-6-1	Special Program Sections .....	4-22

# 4-1 Programming

---

## 4-1-1 User Programs

### Structure of User Programs

---

User programs are created by using the CX-Programmer.

The user programs consist of the following parts.

- Programs  
A program consists of more than one instruction and ends with an END instruction.
- Tasks (Smallest Executable Unit)  
A program is assigned to an interrupt task to execute it. (In the CX-Programmer, the interrupt task number is specified in the program properties.)  
Tasks include cyclic tasks (executed with normal cyclic processing), interrupt tasks (executed when interrupt conditions have been completed) and scheduled interrupt tasks (executed at specified intervals).  
The CP1E can use only one cyclic task.
- Sections  
When creating and displaying programs with the CX-Programmer, the one program can be divided into any number of parts.  
Each part is called a section.  
Sections are created mainly to make programs easier to understand.
- Subroutines  
You can create subroutines within a program.

### User Program Data

---

The user programs are saved in a project file (.CXP) for the CX-Programmer along with other parameters, such as the symbol table, PLC Setup data, and I/O memory data.

### Programming Languages

---

Programs can be written using only ladder programs.



## 4-1-2 Program Capacity

The maximum program capacities of the CP1E CPU Units for all ladder programs (including symbol table and comments) are given in the following table.

The total number of steps must not exceed the maximum program capacity.

Unit type	Model numbers	Program capacity
E□□(S)-type CPU Unit	CP1E-E□□□□□-□	2K steps
N/NA□□(S)-type CPU Unit	CP1E-N/NA□□□□□□-□	8K steps

It is possible to check the program size by selecting **Program - Memory View** in the CX-Programmer.

The size of a ladder instruction depends on the specific instruction and operands that are used.

## 4-1-3 Basics of Programming

This section describes the basics of programming for the CP1E.

### Basic Concepts of Ladder Programming

Instructions are executed in the order that they are stored in memory (i.e., in the order of the mnemonic code). Be sure you understand the concepts of ladder programming, and write the programs in the proper order.

#### ● Basic Points in Creating Ladder Programs

##### Order of Ladder Program Execution

When the ladder diagram is executed by the CPU Unit, the execution condition (i.e., power flow) flows from left to right and top to bottom.

The flow is different from that for circuits that consist of hard-wired control relays.

For example, when the diagram in figure A is executed by the CPU Unit, power flows as though the diodes in brackets were inserted so that output R2 is not controlled by input condition D.

The actual order of execution is indicated on the right with mnemonics.

To achieve operation without these imaginary diodes, the diagram must be rewritten. Also, the power flow in figure B cannot be programmed directly and must be rewritten.

Figure A (Good example)

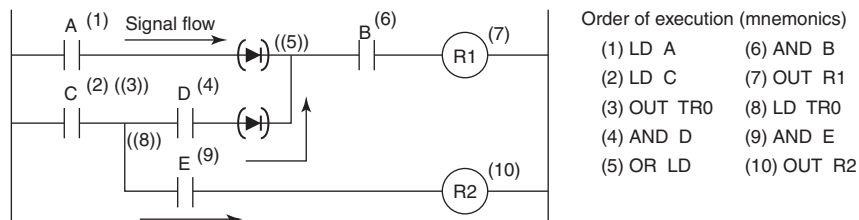
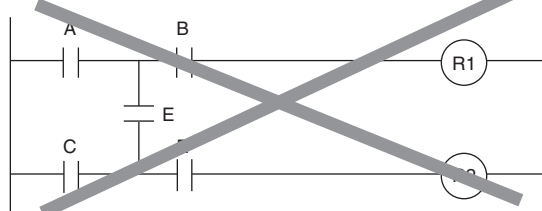
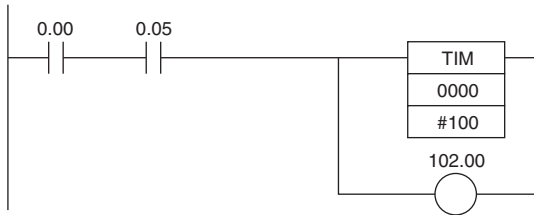

Figure B (Bad example)



● **Number of Times Bits Can be Used and Connection Method**

- There is no limit to the number of I/O bits, work bits, timers, and other input bits that can be used. Program structure should be kept as clear and simple as possible to make the programs easier to understand and maintain even if it means using more input bits.
- There is no limit to the number of input conditions that can be connected in series or in parallel on the rungs.
- Two or more OUT instructions can be connected in parallel.



- Output bits can also be used in input conditions.

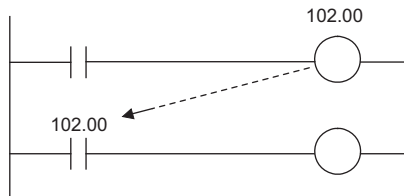

● **Ladder Programming Restrictions**

- A rung error will occur if a ladder program is not connected to both bus bars. The ladder program must be connected to both bus bars so that the execution condition will flow from the left bus bar to the right bus bar. If the rungs are not connected to both bus bars, a rung error will occur during the program check on the CX-Programmer and program transfer will be impossible.

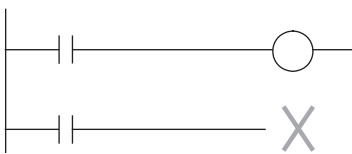

- A rung error will occur if the instruction shown below is made to directly connect to the bus bar without an input condition. OUT instructions, timers, counters, and other output instructions cannot be connected directly to the left bus bar. If one of these instructions is connected directly to the left bus bar, a rung error will occur and program transfer will be impossible.

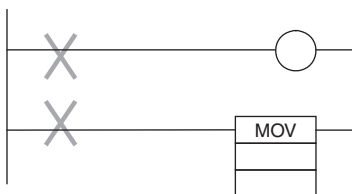

- A location error will occur if an instruction is not connected directly to the right bus bar. An input condition cannot be inserted after an OUT instruction or other output instruction. The input condition must be inserted before an OUT instruction or other output instruction. If it is inserted after an output instruction, then a location error will occur during the program check in the CX-Programmer.

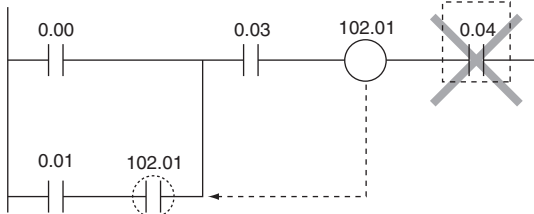

- A warning will occur if the same output bit is used more than once in an OUT instruction. One output bit can be used in one instruction only. Instructions in a ladder program are executed in order from the top rung in each cycle. The result of an OUT instruction in a lower rung will be eventually saved in the output bit. The results of any previous instructions controlling the same bit will be overwritten and not output.

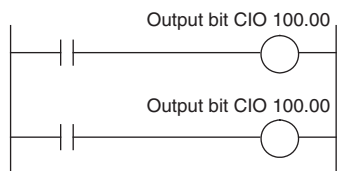

## 4-2 Tasks, Sections, and Symbols

### 4-2-1 Overview of Tasks

There are basically two types of tasks.

Task settings must be made to use interrupt tasks with a CP1E CPU Unit.

Task type	Description	Applicable programming language	Execution condition
Cyclic task	Executed once per cycle	Ladder diagram	Only one for the CP1E. (Normally, the user does not have to consider this.)
Interrupt tasks	Executed when a specific condition occurs. The process being executed is interrupted.	Ladder diagram	An interrupt task is placed into READY status when the interrupt condition occurs. A condition can be set for the following interrupt tasks. <ul style="list-style-type: none"> <li>• Scheduled interrupt tasks</li> <li>• I/O interrupt tasks</li> </ul>

### 4-2-2 Overview of Sections

With the CX-Programmer, programs can be created and displayed in functional units called sections.

Any program in a task can be divided into sections.

Sections improve program legibility and simplifies editing.

### 4-2-3 Overview of Symbols

#### Symbols

I/O memory area addresses or constants can be specified by using character strings registered as symbols.

The symbols are registered in the symbol table of the CX-Programmer.

Programming with symbols enables programming with names without being aware of the addresses.

The symbol table is saved in the CX-Programmer project file (.CXP) along with other parameters, such as the user programs.

#### Symbol Types

There are two types of symbols that can be used in programs.

##### ● Global Symbols

Global symbols can be accessed from all ladder programs in the PLC.

##### ● Local Symbols

Local symbols can be accessed from only one task. They are assigned to individual tasks.

Addresses are allocated to symbols using one of the following methods.

- User Specified allocation
- Automatic allocation using the CX-Programmer  
 The area of memory used for automatic allocations is set by selecting **Memory Allocation - Automatic Address Allocation** from the PLC Menu in the CX-Programmer.

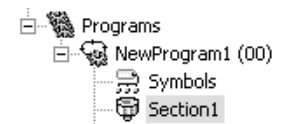
Types of symbols	Project tree in the CX-Programmer	Scope			Address and I/O comment (without a symbol name)
		Access using symbols from a network	Access from other tasks	Access from the local task	
Global symbols	PLC tree 	Not possible.	Possible.	Possible.	Supported
Local symbols	Program tree 		Not possible.	Possible.	Not supported

**Note** “Global” and “local” indicate only the applicable scope of the symbol. They have nothing to do with the applicable scope of memory addresses. Therefore, a warning but not an error will occur in the following cases, and it will be possible to transfer the user program.

- The same addresses is used for two different local symbols.
- The same addresses is used for a global symbol and a local symbol.



**Additional Information**

In programs in the CX-Programmer, global symbols and local symbols can be identified by the following character colors and symbol icons.

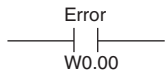
Classification	Display color	Example (default color)
Global symbols	Black (default)	
Local symbols	Blue (default)	

Select *Tools - Options*, and select *Local Symbols* or *Global Symbols in Appearance* to change the color.

# 4-3 Programming Instructions

## 4-3-1 Basic Understanding of Instructions

### Structure of Instructions

Programs consist of instructions. The conceptual structure of the inputs to and outputs from an instruction is shown in the following diagram.

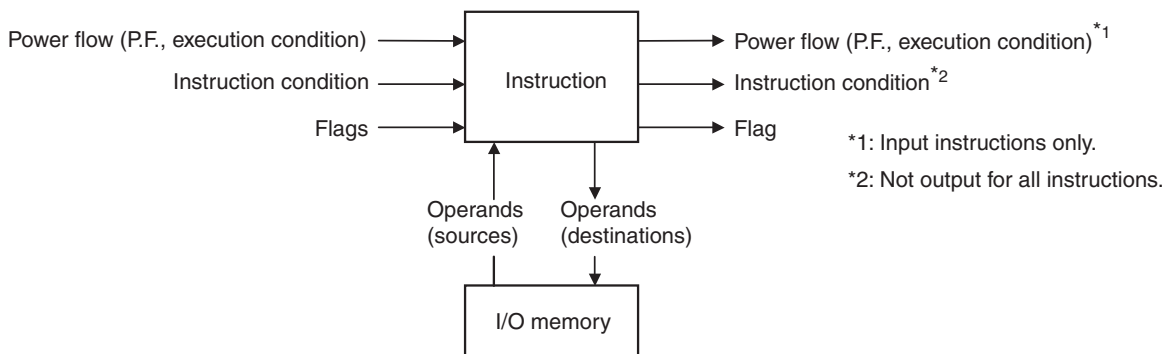

#### ● Power Flow

The power flow is the execution condition that is used to control the execution and instructions when programs are executing normally. In a ladder program, power flow represents the status of the execution condition.

#### Input Instructions

- Load instructions indicate a logical start and outputs the execution condition.

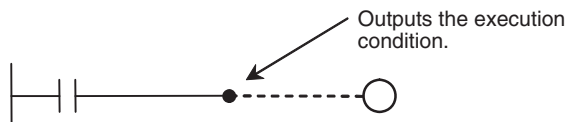

- Intermediate instructions input the power flow as an execution condition and output the power flow to an intermediate or output instruction.

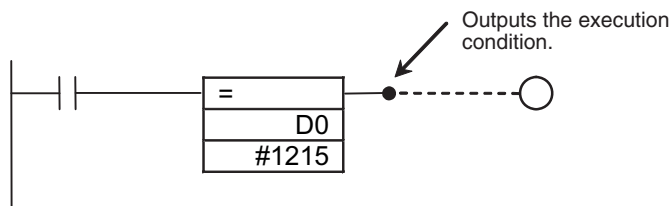

#### Output Instructions

Output instructions execute all functions, using the power flow as an execution condition.

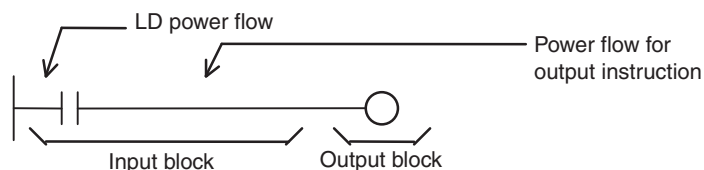

### 4-3-2 Operands

Operands specify preset instruction parameters that are used to specify I/O memory area contents or constants. Operands are given in boxes in the ladder programs.

Addresses and constants are entered for the operands to enable executing the instructions.

Operands are classified as source, destination, or number operands.

Example:

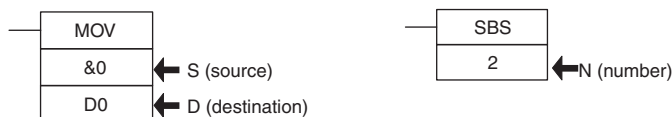

Operand type		Operand symbol	Description	
Source operand	Specifies the address of the data to be read or a constant.	S	Source operand	Source operand other than control data (C)
		C	Control data	Compound data in a source operand that has different meanings depending on bit status.
Destination operand (results)	Specifies the address where data will be written.	D	-	
Number	Specifies a particular number used in the instruction, such as a subroutine number.	N	With numbers, it is not possible to specify an address for indirect specification (except for jump instruction numbers).	

Operands are also called the first operand, second operand, and so on, starting from the top of the instruction.

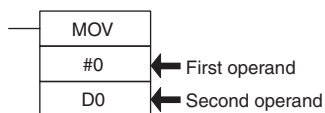

### 4-3-3 Instruction Variations

The following variations are available for instructions to differentiate executing conditions and to refresh data when the instruction is executed (immediate refreshing).

Variation		Symbol	Description
No variation used.		–	These instructions are executed once every cycle while the execution condition is satisfied.
Differentiation variations	ON	@	These instructions are executed only once when the execution condition turns ON.
	OFF	%	These instructions are executed only once when the execution condition turns OFF.
Immediate refreshing		!	Data in the built-in I/O area specified by the operands is refreshed when the instruction is executed.

Example:

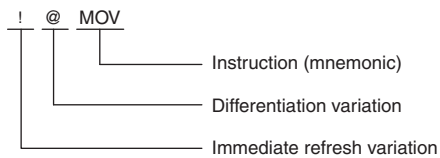

### 4-3-4 Execution Conditions

The following two types of basic and special instructions can be used.

- Non-differentiated instructions: Executed every cycle
- Differentiated instructions: Executed only once

#### Non-differentiated Instructions

##### ● Output Instructions (Instructions That Require Input Conditions)

These instructions are executed once every cycle while the execution condition is satisfied (ON or OFF).

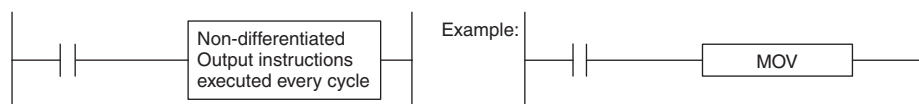

##### ● Input Instructions (Logical Starts and Intermediate Instructions)

These instructions read bit status, make comparisons, test bits, or perform other types of processing every cycle. If the results are ON, the input condition is output (i.e., the execution condition is turned ON).

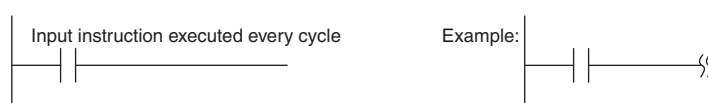



## Input-differentiated Instructions

### ● Upwardly Differentiated Instructions (Instructions Preceded by @)

- Output Instructions

The instruction is executed only during the cycle in which the execution condition changes from OFF to ON.

The instruction is not executed in the following cycle.

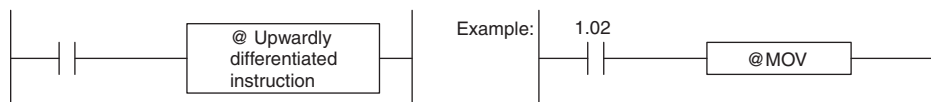

Executes the MOV instruction once when CIO 1.02 turns ON.

- Input Instructions (Logical Starts and Intermediate Instructions)

The instruction reads bit status, makes comparisons, tests bits, or performs other types of processing every cycle and will output an ON execution condition (power flow) when the result changes from OFF to ON.

The execution condition will turn OFF the next cycle.

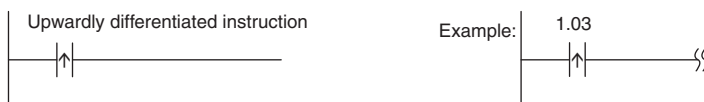

ON execution condition created for one cycle when CIO 1.03 turns ON.

### ● Downwardly Differentiated Instructions (Instruction Preceded by %)

- Output Instructions

The instruction is executed only during the cycle in which the execution condition changes from ON to OFF.

The instruction is not executed in the following cycle.

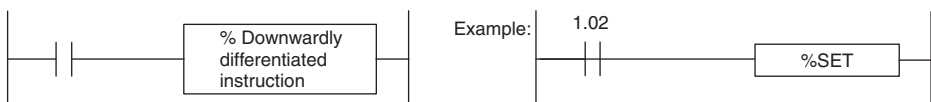

Executes the SET instruction once when CIO 1.02 turns OFF.

- Input Instructions (Logical Starts and Intermediate Instructions)

The instruction reads bit status, makes comparisons, tests bits, or performs other types of processing every cycle and will output an ON execution condition (power flow) when the result changes from ON to OFF.

The execution condition will turn OFF the next cycle.

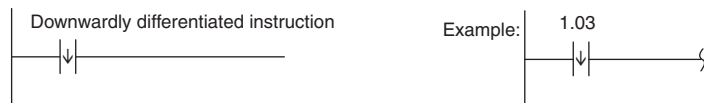

ON execution condition created for one cycle when CIO 1.03 turns ON.

4-3-5 Specifying Data in Operands

Specifying Addresses

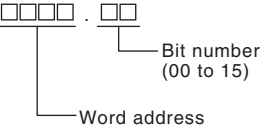
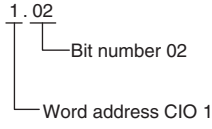
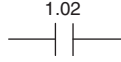
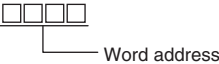
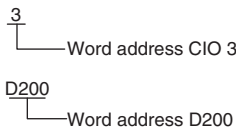
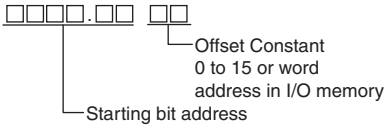
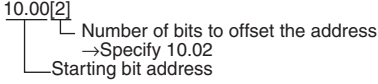
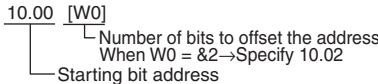
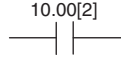
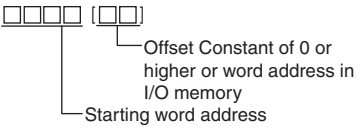
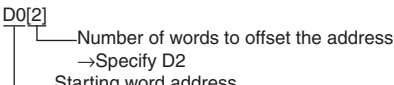
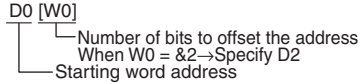
Operand	Description	Example	Application examples
Specifying bit addresses	<p>The word address and bit number are specified directly to specify a bit.</p> 		
Specifying word addresses	<p>The word address is specified directly to specify a 16-bit word.</p> 		MOV 3 D200
Specifying offsets for bit addresses	<p>In brackets, specify the number of bits to offset the specified starting bit address.</p>  <p>A symbol can also be specified for the starting bit address. Only Holding, Work, and DM Area addresses can be used regardless of whether a physical address or symbol is used.</p> <p>A constant or word address in I/O memory can be used for the offset. If a word address is specified, the contents of the word is used as the offset.</p>	 	
Specifying offsets for word addresses	<p>In brackets, specify the number of words to offset the specified starting bit address.</p>  <p>A symbol can also be specified for the starting word address. Only Holding, Work, and DM Area addresses can be used regardless of whether a physical address or symbol is used.</p> <p>A constant or word address in I/O memory can be used for the offset. If a word address is specified, the contents of the word is used as the offset.</p>	 	MOV 3 D0[200]

Operand	Description	Example	Application examples
Specifying indirect DM addresses in Binary Mode	An offset from the beginning of the DM Area is specified. The contents of the address will be treated as binary data (E□□(S)-type CPU Unit 0000 to 2047, N/NA□□(S)-type CPU Unit 0000 to 8191) to specify the word address in DM Area. Add the @ symbol at the front to specify an indirect address in Binary Mode.	@D300 ↓ &256 decimal Contents (#0100 hexadecimal) ↓ Specify D00256 Add @	MOV #0001 @D300
Specifying indirect DM Addresses in BCD Mode	An offset from the beginning of the DM Area is specified. The contents of the address will be treated as BCD data (E□□(S)-type CPU Unit 0000 to 2047, N/NA□□(S)-type CPU Unit 0000 to 8191) to specify the word address in the DM Area. Add an asterisk (*) at the front to specify an indirect address in BCD Mode.	*D200 ↓ #0100 Contents ↓ Specify D100 Add *	MOV #0001 *D200

**Note** For Timer Completion Flags and Counter Completion Flags, there is no distinction between word addresses and bit addresses.

### 4-3-6 Data Formats

The following table shows the data formats that the CP1E CPU Units can handle.

Type	Data format	Decimal equivalent	4-digit hexadecimal																																																																				
Unsigned binary	<table border="0"> <tr> <td></td><td>15</td><td>14</td><td>13</td><td>12</td><td>11</td><td>10</td><td>9</td><td>8</td><td>7</td><td>6</td><td>5</td><td>4</td><td>3</td><td>2</td><td>1</td><td>0</td> </tr> <tr> <td>Binary→</td> <td>2<sup>15</sup></td><td>2<sup>14</sup></td><td>2<sup>13</sup></td><td>2<sup>12</sup></td><td>2<sup>11</sup></td><td>2<sup>10</sup></td><td>2<sup>9</sup></td><td>2<sup>8</sup></td><td>2<sup>7</sup></td><td>2<sup>6</sup></td><td>2<sup>5</sup></td><td>2<sup>4</sup></td><td>2<sup>3</sup></td><td>2<sup>2</sup></td><td>2<sup>1</sup></td><td>2<sup>0</sup></td> </tr> <tr> <td>Hexadecimal→</td> <td>2<sup>3</sup></td><td>2<sup>2</sup></td><td>2<sup>1</sup></td><td>2<sup>0</sup></td><td>2<sup>3</sup></td><td>2<sup>2</sup></td><td>2<sup>1</sup></td><td>2<sup>0</sup></td><td>2<sup>3</sup></td><td>2<sup>2</sup></td><td>2<sup>1</sup></td><td>2<sup>0</sup></td><td>2<sup>3</sup></td><td>2<sup>2</sup></td><td>2<sup>1</sup></td><td>2<sup>0</sup></td> </tr> <tr> <td>Decimal→</td> <td>32768</td><td>16384</td><td>8192</td><td>4096</td><td>2048</td><td>1024</td><td>512</td><td>256</td><td>128</td><td>64</td><td>32</td><td>16</td><td>8</td><td>4</td><td>2</td><td>1</td> </tr> </table>		15	14	13	12	11	10	9	8	7	6	5	4	3	2	1	0	Binary→	2 <sup>15</sup>	2 <sup>14</sup>	2 <sup>13</sup>	2 <sup>12</sup>	2 <sup>11</sup>	2 <sup>10</sup>	2 <sup>9</sup>	2 <sup>8</sup>	2 <sup>7</sup>	2 <sup>6</sup>	2 <sup>5</sup>	2 <sup>4</sup>	2 <sup>3</sup>	2 <sup>2</sup>	2 <sup>1</sup>	2 <sup>0</sup>	Hexadecimal→	2 <sup>3</sup>	2 <sup>2</sup>	2 <sup>1</sup>	2 <sup>0</sup>	2 <sup>3</sup>	2 <sup>2</sup>	2 <sup>1</sup>	2 <sup>0</sup>	2 <sup>3</sup>	2 <sup>2</sup>	2 <sup>1</sup>	2 <sup>0</sup>	2 <sup>3</sup>	2 <sup>2</sup>	2 <sup>1</sup>	2 <sup>0</sup>	Decimal→	32768	16384	8192	4096	2048	1024	512	256	128	64	32	16	8	4	2	1	&0 to &65535	#0000 to #FFFF
	15	14	13	12	11	10	9	8	7	6	5	4	3	2	1	0																																																							
Binary→	2 <sup>15</sup>	2 <sup>14</sup>	2 <sup>13</sup>	2 <sup>12</sup>	2 <sup>11</sup>	2 <sup>10</sup>	2 <sup>9</sup>	2 <sup>8</sup>	2 <sup>7</sup>	2 <sup>6</sup>	2 <sup>5</sup>	2 <sup>4</sup>	2 <sup>3</sup>	2 <sup>2</sup>	2 <sup>1</sup>	2 <sup>0</sup>																																																							
Hexadecimal→	2 <sup>3</sup>	2 <sup>2</sup>	2 <sup>1</sup>	2 <sup>0</sup>	2 <sup>3</sup>	2 <sup>2</sup>	2 <sup>1</sup>	2 <sup>0</sup>	2 <sup>3</sup>	2 <sup>2</sup>	2 <sup>1</sup>	2 <sup>0</sup>	2 <sup>3</sup>	2 <sup>2</sup>	2 <sup>1</sup>	2 <sup>0</sup>																																																							
Decimal→	32768	16384	8192	4096	2048	1024	512	256	128	64	32	16	8	4	2	1																																																							
Signed binary	<table border="0"> <tr> <td></td><td>15</td><td>14</td><td>13</td><td>12</td><td>11</td><td>10</td><td>9</td><td>8</td><td>7</td><td>6</td><td>5</td><td>4</td><td>3</td><td>2</td><td>1</td><td>0</td> </tr> <tr> <td>Binary→</td> <td>2<sup>15</sup></td><td>2<sup>14</sup></td><td>2<sup>13</sup></td><td>2<sup>12</sup></td><td>2<sup>11</sup></td><td>2<sup>10</sup></td><td>2<sup>9</sup></td><td>2<sup>8</sup></td><td>2<sup>7</sup></td><td>2<sup>6</sup></td><td>2<sup>5</sup></td><td>2<sup>4</sup></td><td>2<sup>3</sup></td><td>2<sup>2</sup></td><td>2<sup>1</sup></td><td>2<sup>0</sup></td> </tr> <tr> <td>Hexadecimal→</td> <td>2<sup>3</sup></td><td>2<sup>2</sup></td><td>2<sup>1</sup></td><td>2<sup>0</sup></td><td>2<sup>3</sup></td><td>2<sup>2</sup></td><td>2<sup>1</sup></td><td>2<sup>0</sup></td><td>2<sup>3</sup></td><td>2<sup>2</sup></td><td>2<sup>1</sup></td><td>2<sup>0</sup></td><td>2<sup>3</sup></td><td>2<sup>2</sup></td><td>2<sup>1</sup></td><td>2<sup>0</sup></td> </tr> <tr> <td>Decimal→</td> <td>-32768</td><td>16384</td><td>8192</td><td>4096</td><td>2048</td><td>1024</td><td>512</td><td>256</td><td>128</td><td>64</td><td>32</td><td>16</td><td>8</td><td>4</td><td>2</td><td>1</td> </tr> </table> <p>Sign bit: 1:Negative, 0:Non-negative</p>		15	14	13	12	11	10	9	8	7	6	5	4	3	2	1	0	Binary→	2 <sup>15</sup>	2 <sup>14</sup>	2 <sup>13</sup>	2 <sup>12</sup>	2 <sup>11</sup>	2 <sup>10</sup>	2 <sup>9</sup>	2 <sup>8</sup>	2 <sup>7</sup>	2 <sup>6</sup>	2 <sup>5</sup>	2 <sup>4</sup>	2 <sup>3</sup>	2 <sup>2</sup>	2 <sup>1</sup>	2 <sup>0</sup>	Hexadecimal→	2 <sup>3</sup>	2 <sup>2</sup>	2 <sup>1</sup>	2 <sup>0</sup>	2 <sup>3</sup>	2 <sup>2</sup>	2 <sup>1</sup>	2 <sup>0</sup>	2 <sup>3</sup>	2 <sup>2</sup>	2 <sup>1</sup>	2 <sup>0</sup>	2 <sup>3</sup>	2 <sup>2</sup>	2 <sup>1</sup>	2 <sup>0</sup>	Decimal→	-32768	16384	8192	4096	2048	1024	512	256	128	64	32	16	8	4	2	1	Negative: -1 to -32768	Negative: #8000 to #FFFF
			15	14	13	12	11	10	9	8	7	6	5	4	3	2	1	0																																																					
Binary→	2 <sup>15</sup>	2 <sup>14</sup>	2 <sup>13</sup>	2 <sup>12</sup>	2 <sup>11</sup>	2 <sup>10</sup>	2 <sup>9</sup>	2 <sup>8</sup>	2 <sup>7</sup>	2 <sup>6</sup>	2 <sup>5</sup>	2 <sup>4</sup>	2 <sup>3</sup>	2 <sup>2</sup>	2 <sup>1</sup>	2 <sup>0</sup>																																																							
Hexadecimal→	2 <sup>3</sup>	2 <sup>2</sup>	2 <sup>1</sup>	2 <sup>0</sup>	2 <sup>3</sup>	2 <sup>2</sup>	2 <sup>1</sup>	2 <sup>0</sup>	2 <sup>3</sup>	2 <sup>2</sup>	2 <sup>1</sup>	2 <sup>0</sup>	2 <sup>3</sup>	2 <sup>2</sup>	2 <sup>1</sup>	2 <sup>0</sup>																																																							
Decimal→	-32768	16384	8192	4096	2048	1024	512	256	128	64	32	16	8	4	2	1																																																							
	<p>The data is treated as 16-bit signed binary data using the leftmost bit as the sign bit. The value is expressed in 4-digit hexadecimal.</p> <p>Positive numbers: If the leftmost bit is OFF, it indicates a non-negative value. For 4-digit hexadecimal, the value will be 0000 to 7FFF hex.</p> <p>Negative numbers: If the leftmost bit is ON, it indicates a negative value. For 4-digit hexadecimal, the value be 8000 to FFFF hex. It will be expressed as the 2's complement of the absolute value of the negative value (decimal).</p>	Positive: 0 to 32767	Positive: #0000 to #7FFF																																																																				

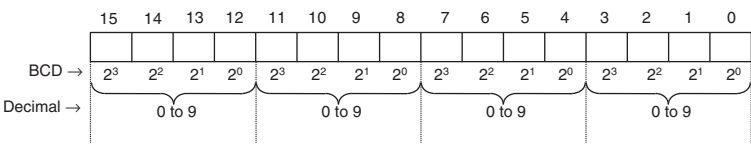
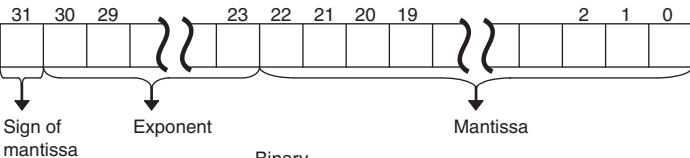
Type	Data format	Decimal equivalent	4-digit hexadecimal
BCD (binary coded decimal)	 <p>BCD →</p> <p>Decimal →</p>	#0 to #9999	#0000 to #9999
Single-precision floating-point decimal	 <p>Value = <math>(-1)^{\text{sign}} \times 1.[\text{Mantissa}] \times 2^{\text{Exponent}}</math></p> <ul style="list-style-type: none"> <li>· Sign bit (bit 31): 1: Negative, 0: Positive</li> <li>· Mantissa: The 23 bits from bit 00 to bit 22 contain the mantissa, i.e., the portion below the decimal point in 1. □□□□....., in binary.</li> </ul> <p>Indicates this value.</p> <ul style="list-style-type: none"> <li>· The 8 bits from bit 23 to bit 30 contain the exponent. The exponent is expressed in binary as the n in <math>2^n</math>. The actual value is <math>2^{n-127}</math>.</li> </ul> <p>This format conforms to the IEEE 754 standard for single-precision floating-point data. It is used only with instructions that convert or calculate floating-point data.</p> <ul style="list-style-type: none"> <li>• Input using operands in the CX-Programmer as signed decimal or 32-bit hexadecimal with the # symbol.</li> <li>• When inputting operands in the I/O Memory Edit/Monitor Window of the CX-Programmer as signed decimal values with seven digits or less, the value will be automatically converted to scientific notation (mantissa × 10<sup>Exponent</sup>) for setting and monitoring. Inputs must be made using scientific notation for values with eight or more digits. Example: When -1234.00 is input, it will become -1.234000e+003 in scientific notation. For the mantissa × 10<sup>Exponent</sup>, the value before the e is the mantissa and the value after the e is the signed exponent.</li> </ul>	*	-

\* Data range for single-precision floating-point decimal:  $-3.402823 \times 10^{38} \leq \text{Value} \leq -1.175494 \times 10^{-38}$ , 0,  $+1.175494 \times 10^{-38} \leq \text{Value} \leq 3.402823 \times 10^{38}$

### 4-3-7 I/O Refresh Timing

The following methods are used to refresh external I/O.

- Cyclic refreshing
- Immediate refreshing (instructions with the ! variation and IORF)

#### Cyclic Refreshing

I/O is all refreshed after ladder programs are executed.

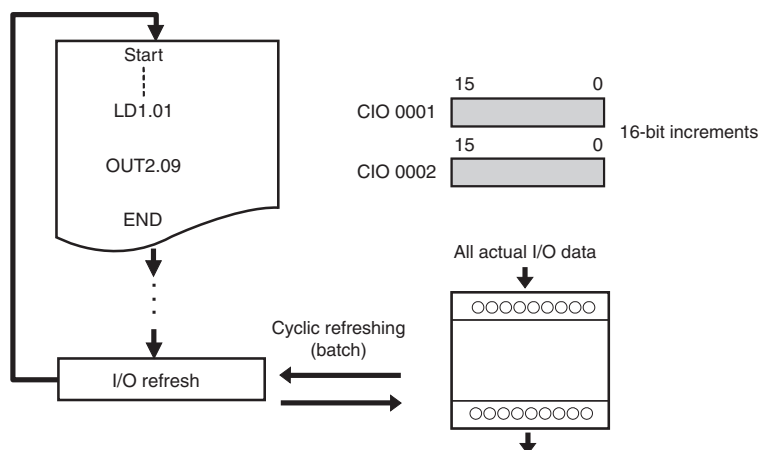

Execute an instruction with the immediate refresh variation or an IORF instruction to perform I/O refreshing while ladder programming is being executed.

#### Immediate Refresh

The method of specifying immediate refreshing depends on whether the object to be refreshed is built-in I/O or an Expansion Unit.

- To specify immediate refreshing for the CPU Unit's built-in I/O, specify the immediate refresh variation (!) of the instruction.
- To specify immediate refreshing for Expansion I/O or an Expansion Unit, use the IORF instruction.

#### ● Instructions with Refresh Variation (!)

Add an exclamation mark (!) in front of the instruction to specify immediate refreshing.

I/O will be refreshed as shown below when an instruction is executing if a real I/O bit in the CPU Unit's built-in I/O is specified as an operand.

- Bit Operands: I/O refreshing for the bit will be performed.
- Word Operands: I/O refreshing for the 16 specified bits will be performed.
- Input or Source Operands: Inputs are refreshed immediately before the instruction is executed.
- Output or Destination Operands: Outputs are refreshed immediately after the instruction is executed.

#### ● IORF(097) Instruction

An I/O refresh (IORF) instruction is supported as a special instruction to refresh actual I/O data in the specified word range. By using this instruction, it is possible to refresh all data or data in a specified range of actual I/O in CP-series Expansion I/O and Expansion Unit during the cycle.

IORF instruction can also refresh actual I/O data in an NA-type CPU Unit at CIO 90, CIO 91 and CIO 190.



#### Precautions for Correct Use

It is not possible to use the immediate refresh variation (!) for the actual I/O of Expansion I/O or an Expansion Unit. Use the IORF instruction.

## 4-4 Constants

### Overview

Constants are numeric values expressed in 16 or 32 bits and can be specified as instruction operands. The following types of constants are supported.

- Bit Strings or Numeric Values (Integers)
  - Decimal values (with & symbol), hexadecimal values (with # symbol), BCD values (with # symbol), or signed decimal values (with + or - symbol)
- Operands Specifying Numbers
  - Decimal Notation (No Symbol)
- Floating Point (Real Number) Notation
  - Signed decimal notation (with + or - symbol and decimal point)

### Notation and Ranges

#### ● Using Operands for Bit Strings or Numeric Values (Integers)

##### Unsigned Binary

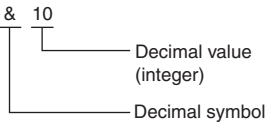
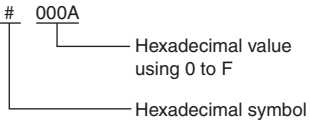
Data type	Decimal values	Hexadecimal values	
<b>Notation</b>	With & symbol 	With # symbol 	
<b>Application example</b>	MOV &10 D0 Stores 10 decimal (#000A hex) in D0.	MOV #000A D0 Stores #000A hex (&10 decimal) in D0.	
<b>Precautions for correct use</b>	<ul style="list-style-type: none"> <li>• An error will occur and the left bus bar will be displayed in red if a hexadecimal value including A to F is input with &amp; from the CX-Programmer.</li> <li>• The input will be treated as an address in the CIO Area and the contents of that address will be specified if a decimal value without &amp; is input from the CX-Programmer.</li> </ul>	<ul style="list-style-type: none"> <li>• An error will occur and the left bus bar will be displayed in red if a hexadecimal value including A to F is input without # from the CX-Programmer.</li> <li>• The input will be treated as an address in the CIO Area and the contents of that address will be specified if a decimal value without # is input from the CX-Programmer.</li> </ul>	
<b>Range</b>	<b>16 bits</b>	&0 to 65535	#0000 to #FFFF
	<b>32 bits</b>	&0 to 4294967295	#00000000 to #FFFFFFFF

### Signed Binary

Data type		Decimal values	Hexadecimal values
<b>Notation</b>		Signed + or - 	With # symbol 
<b>Application example</b>		MOV -10 D0 Stores 10 decimal (#FFF6 hex) in D0.	MOV # FFF6 D0 Stores #FFF6 hex (10 decimal) in D0.
<b>Precautions for correct use</b>		The input will be treated as an address in the CIO Area and the contents of that address will be specified if a decimal value without + or - is input from the CX-Programmer.	<ul style="list-style-type: none"> <li>An error will occur and the left bus bar will be displayed in red if a hexadecimal value including A to F is input without # from the CX-Programmer.</li> <li>The input will be treated as an address in the CIO Area and the contents of that address will be specified if a decimal value without # is input from the CX-Programmer.</li> </ul>
<b>Range</b>	<b>16 bits</b>	Negative: -32768 to -1	Negative: #8000 to #FFFF
		Positive: 0 to +32767	Positive: #0000 to #7FFF
	<b>32 bits</b>	Negative: -2147483648 to -1	Negative: #80000000 to #FFFFFFFF
		Positive: 0 to +2147483647	Positive: #00000000 to #7FFFFFFF

### Unsigned BCD

Data type		Decimal values	BCD values
<b>Notation</b>		None	
<b>Application example</b>			+B #0010 D0 D1 Adds #0010 and the contents of D0 as BCD data and stores the result in D1.
<b>Precautions for correct use</b>			The input will be treated as an address in the CIO Area and the contents of that address will be specified if a decimal value without # is input from the CX-Programmer.
<b>Range</b>	<b>16 bits</b>	None	#0000 to #9999
	<b>32 bits</b>		#0000 0000 to #99999999

● Using Operands to Specify Numbers

Data type	Decimal values	Hexadecimal values or BCD values
Notation	No symbol (value only)  $\overset{10}{\text{Number only}}$	Not possible.
Application example	SBS 0 Jumps to subroutine 0.	
Precautions for correct use	An error will occur and the left bus bar will be displayed in red if a decimal value is input with & from the CX-Programmer.	

● Using Floating-point (Real Number) Notation for Operands

Data type	Decimal values	Hexadecimal values
Notation	With + or -  $\overset{+}{\text{0.10}}$ Decimal value (real number) + or - sign	With # symbol (for single-precision data)  $\overset{\#}{\text{3DCCCCD}}$ Hexadecimal value using 0 to F Hexadecimal symbol
Application example	FIX +0.10 D0 Converts floating point +0.10 into 16-bit signed binary data and stores the integer portion in D0.	FIX #3DCCCCD D0 Converts floating point #3DCCCCD (+0.10 decimal) into 16-bit signed binary data and stores the integer portion in D0.
Precautions for correct use	The input will be treated as an address in the CIO Area, an error will occur, and the left bus bar will be displayed in red if a decimal value with a decimal point is input without + from the CX-Programmer.	The input will be treated as an address in the CIO Area, an error will occur, and the left bus bar will be displayed in red if a hexadecimal value including A to F is input without # from the CX-Programmer.



**Additional Information**

- Zero suppression can be used when inputting any data type. For example, “&2” and “&02”, “#000F” and “#F” are treated as the same.
- “BIN” indicates binary data.
- BCD data is binary coded decimal.



## 4-5 Specifying Offsets for Addresses

### 4-5-1 Overview

When an address is specified for an instruction operand, it is possible to change the specified address by specifying in brackets an offset for the specified address.

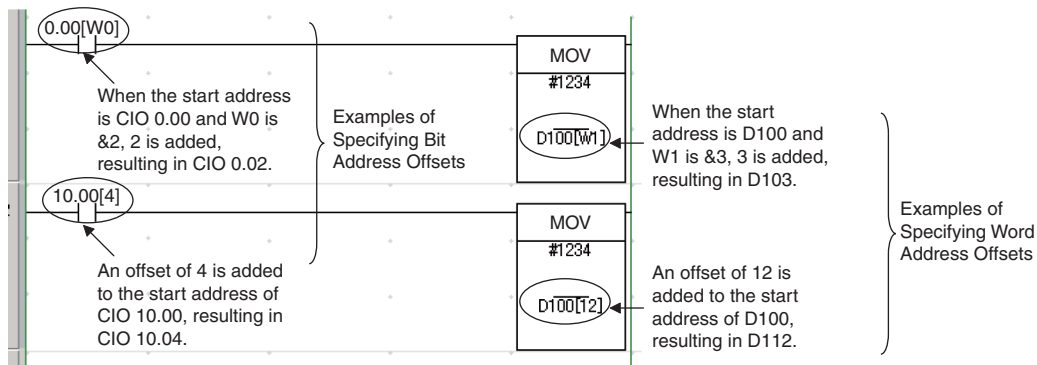

#### ● Bit Addresses

The bit address is offset by the amount specified by n (number of bits) from A (start bit address).

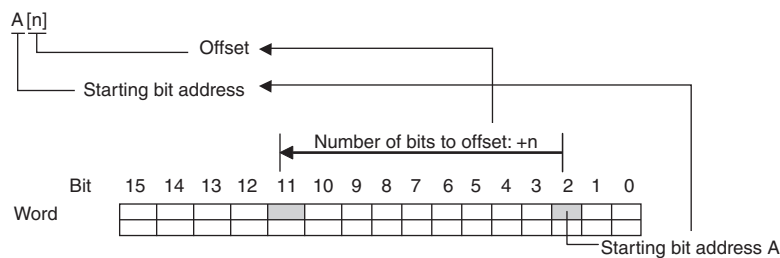

#### Start Bit Address

It is possible to specify the start bit address with a bit address or with a symbol (except the NUMBER data type cannot be used).

Offsetting is possible for all addresses except the DM Areas.

When specifying symbols, make the symbol table setting as the array variation. The number of arrays will be the maximum number of offset + 1 bit at least.

The I/O comment for the start bit address is displayed.

#### Offset

The offset can be specified as a decimal constant, word address (but CIO Area addresses cannot be specified), or a one-word symbol (i.e., symbols with the following data types: INT, UINT, WORD, CHANNEL).

Words in the Auxiliary Area (A) can only be specified as a decimal constant.

If a word address is specified, the contents of the specified word is used as the offset.

If the offset exceeds bit 15 in the specified word, offsetting will continue from bit 00 in the next word.

If the offset is specified indirectly, make sure that the final bit address does not exceed the upper limit of the memory area by using input comparison or other instruction.

Examples:

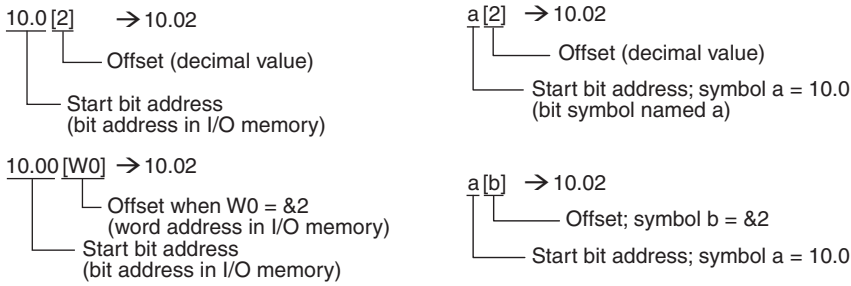

● **Word Addresses**

The word address is offset by the amount specified by n (number of offset words) from A (start word address).

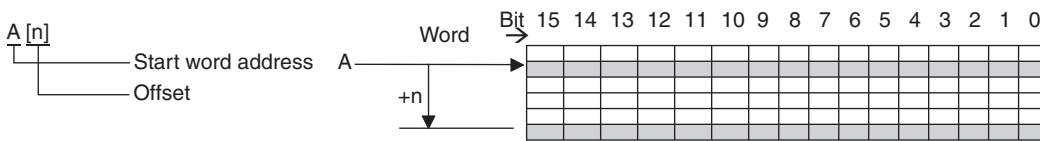

**Start Word Address**

It is possible to specify the start word address with a word address or with a symbol (except the NUMBER data type cannot be used).

Offsetting is possible only for addresses in the Holding, Word, and DM Areas.

The I/O comment for the start bit address is displayed.

When specifying symbols, make the symbol table setting as the array variation. The number of arrays will be the maximum number of offset + 1 word at least.

**Offset**

The offset can be specified as a decimal constant, word address (but CIO Area addresses cannot be specified), or one-word symbol (i.e., symbols with the following data types: INT, UINT, WORD, CHANNEL).

If a word address or symbol is specified, the contents of the specified word is used as the offset.

If the offset exceeds bit 15 in the specified word, offsetting will continue from bit 00 in the next word.

If the offset is specified indirectly, make sure that the final bit address does not exceed the upper limit of the memory area by using input comparison or other instruction.

Examples:

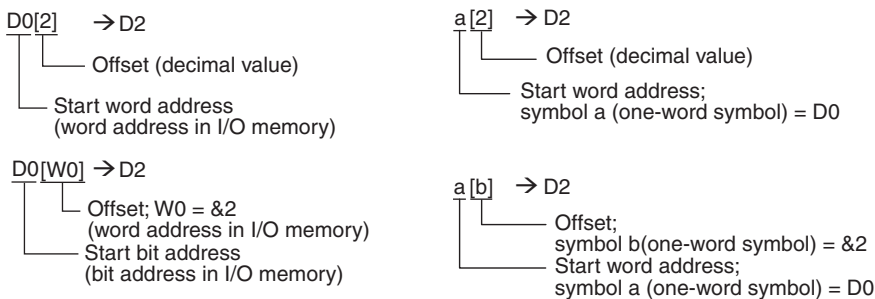

## ⚠ Caution

**Program so that the memory area of the start address is not exceeded when using a word address or symbol for the offset.**

For example, write the program so that processing is executed only when the indirect specification does not cause the final address to exceed the memory area by using an input comparison instruction or other instruction.

If an indirect specification causes the address to exceed the area of the start address, the system will access data in other area, and unexpected operation may occur.



### 4-5-2 Application Examples for Address Offsets

It is possible to dynamically specify the offset by specifying a word address in I/O memory for the offset in the brackets. The contents of the specified word address will be used as the offset.

For example, execution can be performed by increasing the address by incrementing the value in the brackets and using only one instruction.

#### ● Ladder Program Example

In this example, two areas of consecutive data are used: D0 to D99 and D100 to D199.

The contents of corresponding words are added starting from the specified starting point, W0, to the end of the areas and the sums are output to D200 to D299 starting from the specified offset from D200.

For example, if W0 is 30, the corresponding words from D30 to D99 and D130 to D199 are added, and the sums are output to D230 to D299.

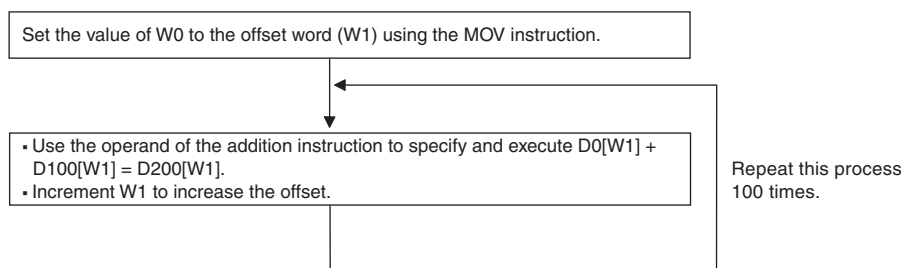

Each process is performed with an input comparison instruction (<) as the execution condition so that W1 does not exceed &100 to make sure that the upper limit of the indirect addressing range is not exceeded.

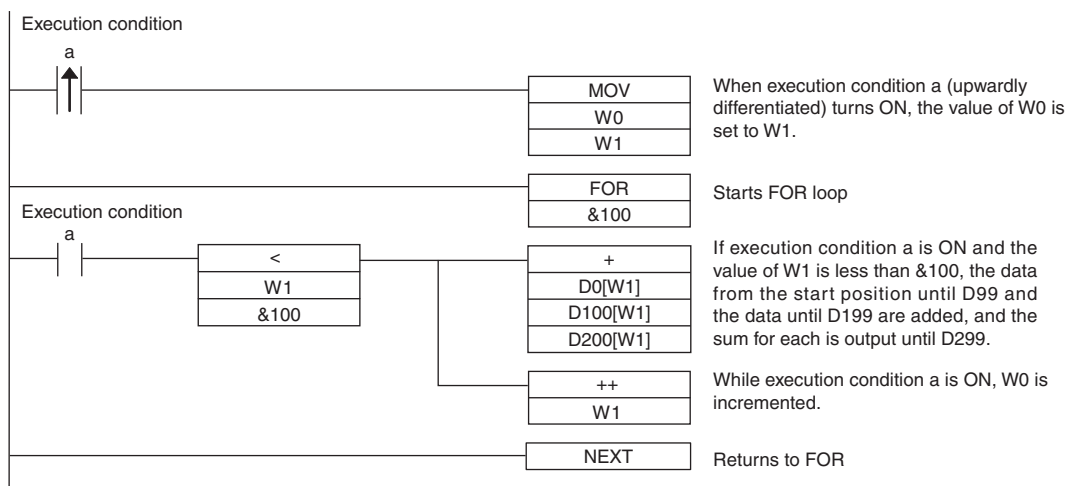

## 4-6 Ladder Programming Precautions

### 4-6-1 Special Program Sections

For CP1E CPU Units, programs have special program sections that will control instruction conditions. The following special program sections are available.

Program sections	Instructions	Instruction conditions	Status
Subroutine sections	SBS, SBN, and RET instructions	Subroutine program is executed.	The subroutine program section between SBN and RET instructions is executed.
IL-ILC sections	IL and ILC instructions	During IL	The output bits are turned OFF and timers are reset. Other instructions will not be executed and previous status will be maintained.
Step ladder sections	STEP instructions		
FOR-NEXT sections	FOR and NEXT instructions	Break in progress.	Looping

### Instruction Combinations

The following table shows which of the special instructions can be used inside other program sections.

	Subroutine sections	IL-ILC sections	MILH and MILR-MILC sections	Step ladder sections	FOR-NEXT sections
<b>Subroutine sections</b>	No	No	No	No	No
<b>IL-ILC sections</b>	Yes	No	No	No	Yes
<b>MILH and MILR-MILC sections</b>	Yes	No	Yes	No	Yes
<b>Step ladder sections</b>	No	Yes	Yes	No	No
<b>FOR-NEXT sections</b>	Yes	Yes	Yes	No	Yes

### Subroutines

Place all the subroutines together just after all of the main program and before the END instruction.

A subroutine cannot be placed in a step ladder, block program, or FOR-NEXT section.

If instructions other than those in a subroutine are placed after a subroutine (SBN to RET), those instructions will not be executed.

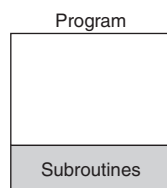

## Instructions not Supported in Subroutines

The following instructions cannot be used in a subroutine.

Classification by function	Mnemonic	Instruction
Step Ladder Instructions	STEP	STEP DEFINE
	SNXT	STEP NEXT

## Instructions not Supported in Step Ladder Program Sections

The following instructions cannot be used in step ladder program sections.

Classification by function	Mnemonic	Instruction
Sequence Control Instructions	FOR, NEXT, and BREAK	FOR, NEXT, and BREAK LOOP
	END	END
	IL and ILC	INTERLOCK and INTERLOCK CLEAR
	JMP and JME	JUMP and JUMP END
	CJP	CONDITIONAL JUMP and CONDITIONAL JUMP NOT
Subroutines	SBN and RET	SUBROUTINE ENTRY and SUBROUTINE RETURN

**Note** A step ladder program section can be used in an interlock section (between IL and ILC). The step ladder section will be completely reset when the interlock condition is ON.



# 5

## I/O Memory

This section describes the types of I/O memory areas in a CP1E CPU Unit and the details.

Be sure you understand the information in the section before attempting to write ladder diagrams.

Refer to the *CP1E CPU Unit Instructions Reference Manual* (Cat. No. W483) for detailed information on programming instructions.

5

---

<b>5-1 Overview of I/O Memory Areas</b> .....	<b>5-2</b>
5-1-1 I/O Memory Areas .....	5-2
5-1-2 I/O Memory Area Address Notation .....	5-5
5-1-3 I/O Memory Areas .....	5-6
<b>5-2 I/O Bits</b> .....	<b>5-7</b>
<b>5-3 Work Area (W)</b> .....	<b>5-8</b>
<b>5-4 Holding Area (H)</b> .....	<b>5-9</b>
<b>5-5 Data Memory Area (D)</b> .....	<b>5-11</b>
<b>5-6 Timer Area (T)</b> .....	<b>5-13</b>
<b>5-7 Counter Area (C)</b> .....	<b>5-15</b>
<b>5-8 Auxiliary Area (A)</b> .....	<b>5-17</b>
<b>5-9 Condition Flags</b> .....	<b>5-19</b>
<b>5-10 Clock Pulses</b> .....	<b>5-21</b>

## 5-1 Overview of I/O Memory Areas

This section describes the I/O memory areas in a CP1E CPU Unit.

### 5-1-1 I/O Memory Areas

Data can be read and written to I/O memory from the ladder programs. I/O memory consists of an area for I/O with external devices, user areas, and system areas.

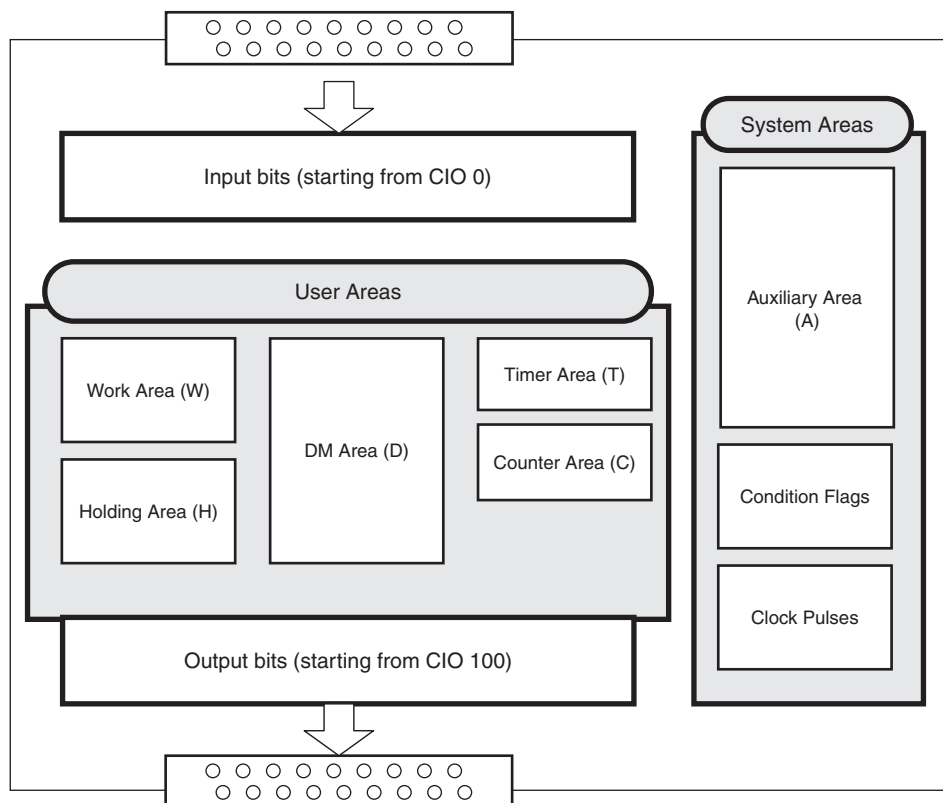

### CIO Area (CIO 0 to CIO 289)

In the CIO Area, input bit addresses range from CIO 0 to CIO 99, output bit addresses range from CIO 100 to CIO 199 and addresses for serial PLC links range from CIO 200 to CIO 289.

For NA-type CPU Units, built-in analog input terminals are CIO 90 and CIO 91, built-in analog output terminal is CIO 190.

The bits and words in the CIO Area are allocated to built-in I/O terminals on the CP1E CPU Unit and to the Expansion Units and Expansion I/O Units.

Input words and output bits that are not allocated may be used as work bits in programming.

Refer to *5-2 I/O Bits*



## User Areas

These areas can be used freely by the user.

### ● Work Area (W)

The Work Area is part of the internal memory of the CPU Unit. It is used in programming. Unlike the input bits and output bits in the CIO Area, I/O to and from external devices is not refreshed for this area.

Use this area for work words and bits before using any words in the CIO Area. These words should be used first in programming because they will not be assigned to new functions in future versions of CP1E CPU Units.

Refer to *5-3 Work Area (W)*

### ● Holding Area (H)

The Holding Area is part of the internal memory of the CPU Unit. It is used in programming. Unlike the input bits and output bits in the CIO Area, I/O to and from external devices is not refreshed for this area.

These words retain their content when the PLC is turned ON or the operating mode is switched between PROGRAM mode and RUN or MONITOR mode.

This data is unstable if power is reset when the battery is not mounted.

Refer to *5-4 Holding Area (H)*

### ● Data Memory Area (D)

This data area is used for general data storage and manipulation and is accessible only by word (16 bits).

These words retain their content when the PLC is turned ON or the operating mode is switched between PROGRAM mode and RUN or MONITOR mode.

Specified words can be retained in the built-in EEPROM backup memory using Auxiliary Area bits.

This data is unstable if power is reset when the battery is not mounted.

Refer to *5-5 Data Memory Area (D)*

### ● Timer Area (T)

There are two parts to the Timer Area: the Timer Completion Flags and the timer Present Values (PVs).

Up to 256 timers with timer numbers T0 to T255 can be used.

- Timer Completion Flags

Each Timer Completion Flag is accessed as one bit using the timer number.

A Completion Flag is turned ON when the set time of the timer elapses.

- Timer PVs

Each timer PV is accessed as one word (16 bits) using the timer number.

The PV increases or decreases as the timer operates.

Refer to *5-6 Timer Area (T)*

### ● Counter Area (C)

There are two parts to the Counter Area: the Counter Completion Flags and the Counter Present Values (PVs).

Up to 256 counters with counter numbers C0 to C255 can be used.

These words retain their content when the PLC is turned ON or the operating mode is switched between PROGRAM mode and RUN or MONITOR mode.

This data is unstable if power is reset, when the battery is not mounted.

- Counter Completion Flags

Each Counter Completion Flag is accessed as one bit using the counter number.

A Completion Flag is turned ON when the set value of the counter is reached.

- Counter PVs

Each counter PV is accessed as one word (16 bits) using the timer number.

The PVs count up or down as the counter operates.

Refer to *5-7 Counter Area (C)*

## System Areas

---

System Areas contain bits and words with preassigned functions.

### ● Auxiliary Area (A)

The words and bits in this area have preassigned functions.

Refer to *A-2 Auxiliary Area Allocations by Address*

### ● Condition Flags

The Condition Flags include the flags that indicate the results of instruction execution, as well as the Always ON and Always OFF Flags.

The Condition Flags are specified with global symbols rather than with addresses. For example: P\_on

### ● Clock Pulses

The Clock Pulses are turned ON and OFF by the CPU Unit's internal timer.

The Clock Pulses are specified with global symbols rather than with addresses. For example: P\_0\_02

## 5-1-2 I/O Memory Area Address Notation

An I/O memory can be addressed using word addresses or bit addresses. The word addresses and bit addresses are given in decimal format.

### ● Word Addresses

Specifies a 16-bit word.

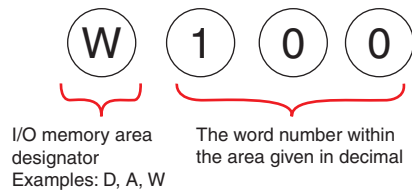

### ● Bit Addresses

A bit address specifies one of the 16 bits in a word.

The word number and bit number are separated with a period.

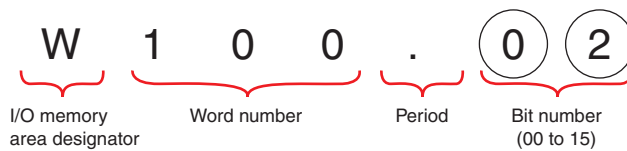

On the CX-Programmer, addresses in the CIO Area (including addresses for Serial PLC Links) are given with no I/O memory area designator. "CIO" is used as the I/O memory area designator in this manual for clarity.

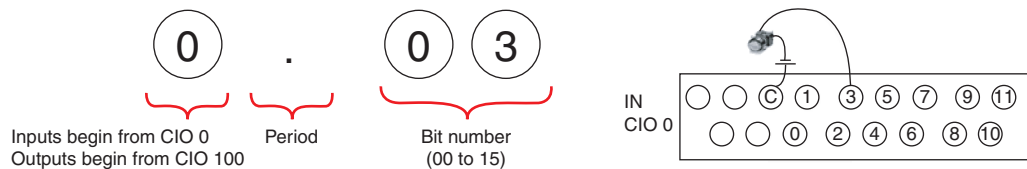

### 5-1-3 I/O Memory Areas

Name		No. of bits	Word addresses	Remarks	Reference
CIO Area	Input Bits	1,600 bits (100 words)	CIO 0 to CIO 99	–	Refer to 5-2 I/O Bits.
	Output Bits	1,600 bits (100 words)	CIO 100 to CIO 199	–	
	Serial PLC Link Words	1,440 bits (90 words)	CIO 200 to CIO 289	–	Refer to Section 14 Serial Communications.
Work Area (W)		1,600 bits (100 words)	W0 to W99	–	Refer to 5-3 Work Area (W).
Holding Area (H)		800 bits (50 words)	H0 to H49	The data is unstable if power is interrupted, when the battery is not mounted.	Refer to 5-4 Holding Area (H).
Data Memory Area (D)	E□□(S)-type CPU Unit	2K words	D0 to D2047	Data in specified words of the DM Area can be retained in the built-in EEPROM in the backup memory by using a bit in the Auxiliary Area. Applicable words: D0 to D1499 (One word can be specified at a time.)	Refer to 5-5 Data Memory Area (D).
	N/NA□□(S)-type CPU Unit	8K words	D0 to D8191	Data in specified words of the DM Area can be retained in the built-in EEPROM in the backup memory by using a bit in the Auxiliary Area. Applicable words: D0 to D6999 (One word can be specified at a time.)	
Timer Area (T)	Present values	256	T0 to T255	–	Refer to 5-6 Timer Area (T).
	Timer Completion Flags	256		–	
Counter Area (C)	Present values	256	C0 to C255	The data is unstable if power is interrupted, when the battery is not mounted.	Refer to 5-7 Counter Area (C).
	Counter Completion Flags	256		–	
Auxiliary Area (A)	Read only	7,168 bits (448 words)	A0 to A447	The data is unstable if power is interrupted, when the battery is not mounted.	Refer to A-2 Auxiliary Area Allocations by Address.
	Read-write	4,896 bits (306 words)	A448 to A753		

## 5-2 I/O Bits

### Overview

These words are allocated to built-in I/O terminals of CP1E CPU Units, built-in analog I/O terminals of CP1E NA-type CPU Units and CP-series Expansion Units and Expansion I/O Units.

### Notation

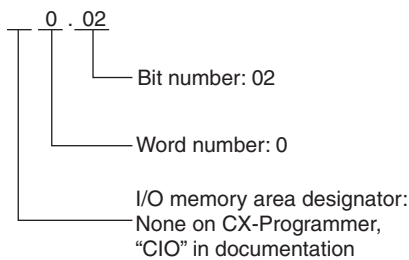

### Range

Input bits: CIO 0.00 to CIO 99.15 (100 words)

Output bits: CIO 100.00 to CIO 199.15 (100 words)

### Applications

Built-in inputs can be used as basic inputs, interrupt inputs, quick-response inputs or high-speed counters.

Built-in outputs can only be used as basic outputs.

Refer to *Section 8 Overview of Built-in Functions and Allocations* for details.

### Details

- Bits in the CIO Area can be force-set and force-reset.
- The contents of the CIO Area will be cleared in the following cases:
  - When the operating mode is changed between PROGRAM or MONITOR mode and RUN mode
  - When the PLC power is reset
  - When the CIO Area is cleared from the CX-Programmer
  - When PLC operation is stopped due to a fatal error other than an FALS error occurs. (The contents of the CIO Area will be retained when FALS is executed.)



#### Additional Information

Words that are not allocated to the built-in I/O terminals of the CPU Units, built-in analog I/O terminals of CP1E NA-type CPU Units and the Expansion Units and Expansion I/O Units can only be used in programming. It is the same as the Work Area.

## 5-3 Work Area (W)

### Overview

The Work Area is part of the internal memory of the CPU Unit. It is used in programming. Unlike the input bits and output bits in the CIO Area, I/O to and from external devices is not refreshed for this area.

### Notation

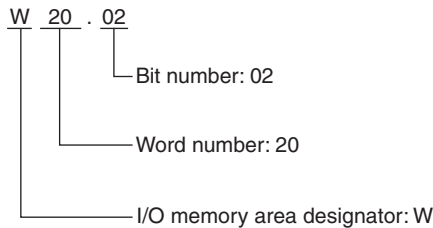

### Range

The Work Area contains 100 words with addresses ranging from W0 to W99.

### Applications

It is sometimes necessary to use the same set of input conditions many times in the same program. In this case a work bit can be used to store the final condition to simplify programming work and program design.

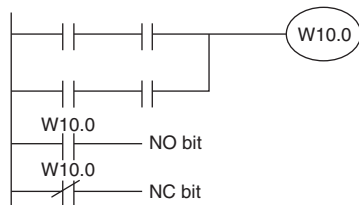

Storing a Condition in a Work Bit

### Details

- Bits in the Work Area can be force-set and force-reset.
- The contents of the Work Area will be cleared in the following cases:
  - When the operating mode is changed between PROGRAM or MONITOR mode and RUN mode
  - When the PLC power is reset
  - When the Work Area is cleared from the CX-Programmer
  - When PLC operation is stopped due to a fatal error other than an FALS error occurs. (The contents of the Work Area will be retained when FALS is executed.)

## 5-4 Holding Area (H)

### Overview

The Holding Area is part of the internal memory of the CPU Unit. It is used in programming. Unlike the input bits and output bits in the CIO Area, I/O to and from external devices is not refreshed for this area.

These words retain their content when the PLC is turned ON or the operating mode is switched between PROGRAM mode and RUN or MONITOR mode.



### Precautions for Safe Use

With an E□□(S)-type CPU Unit or with an N/NA□□(S)-type CPU Unit without a Battery, the contents of the DM Area (D) \*, Holding Area (H), the Counter Present Values (C), the status of Counter Completion Flags (C), and the status of bits in the Auxiliary Area (A) related to clock functions may be unstable when the power supply is turned ON.

\* This does not apply to areas backed up to EEPROM using the DM backup function.

If the DM backup function is being used, be sure to refer to 3-2-4 *Initializing I/O Memory at Startup* for details.

### Notation

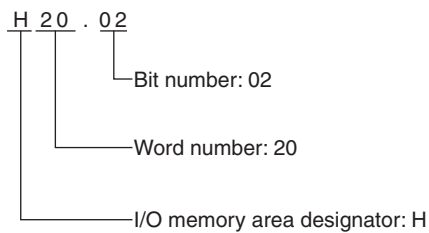

### Range

The Holding area contains 50 words with addresses ranging from H0 to H49.

### Applications

The Holding Area is used when you want to resume operation after a power interruption using the same status as before the power interruption.

## Details

- Bits in the Holding Area can be force-set and force-reset.
- When a self-maintaining bit is programmed with a Holding Area bit, the self-maintaining bit will not be cleared even when the power is reset.
- If a Holding Area bit is not used for the self-maintaining bit, the bit will be turned OFF and the self-maintaining bit will be cleared when the power is reset.

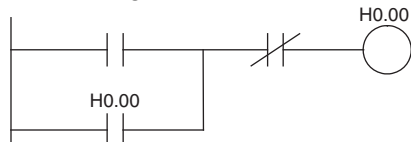

- If a Holding Area bit is used but not programmed as a self-maintaining bit, the bit will be turned OFF by execution condition A when the power is reset.

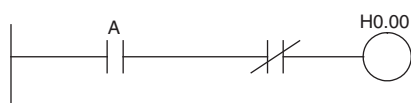

### Precautions for Correct Use

- When a Holding Area bit is used in a KEEP instruction, never use a normally closed condition for the reset input.

When the power supply goes OFF or is temporarily interrupted, the input will go OFF before the PLC's internal power supply and the Holding Area bit will be reset.

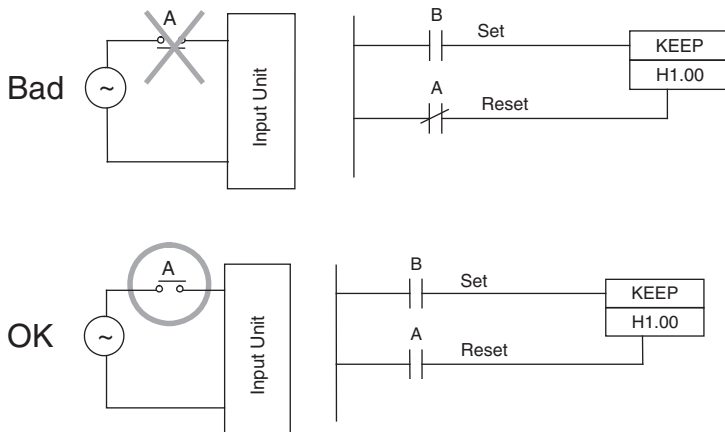



## 5-5 Data Memory Area (D)

### Overview

This data area is used for general data storage and manipulation and is accessible only by word (16 bits).

These words retain their contents when the PLC is turned ON or the operating mode is switched between PROGRAM mode and RUN or MONITOR mode.

Some words in the DM Area can be saved to the built-in EEPROM backup memory using Auxiliary Area bits. These words are specifically referred to as the backed up words in the DM Area.



#### Precautions for Safe Use

With an E□□(S)-type CPU Unit or with an N/NA□□(S)-type CPU Unit without a Battery, the contents of the DM Area (D) \*, Holding Area (H), the Counter Present Values (C), the status of Counter Completion Flags (C), and the status of bits in the Auxiliary Area (A) related to clock functions may be unstable when the power supply is turned ON.

\* This does not apply to areas backed up to EEPROM using the DM backup function.

If the DM backup function is being used, be sure to refer to 3-2-4 *Initializing I/O Memory at Startup* for details.

### Notation

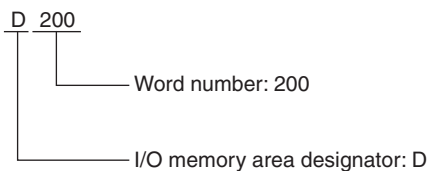

### Range

- E□□(S)-type CPU Units have DM Area addresses ranging from D0 to D2047. Of these, D0 to D1499 can be backed up in backup memory (built-in EEPROM).
- N/NA□□(S)-type CPU Units have DM Area addresses ranging from D0 to D8191. Of these, D0 to D6999 can be backed up in backup memory (built-in EEPROM).

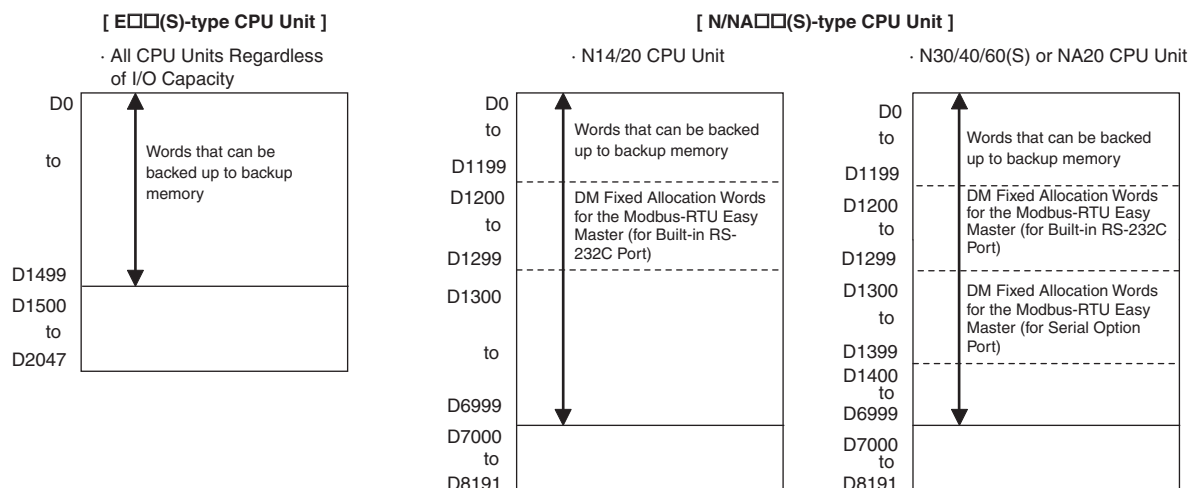

## Applications

The DM Area is for storing numeric data. It can be used for data exchange with Programmable Terminals, serial communications devices, such as Inverters, and Analog I/O Units or Temperature I/O Units.

## Details

Bits in the DM Area cannot be addressed individually.

### ● Backing Up to the Built-in EEPROM Backup Memory

- The number of words set in the PLC Setup can be saved to the built-in EEPROM backup memory during operation by turning ON the DM Backup Start bit (A751.15).
- Specify in the PLC Setup whether to read the data in the DM Area words to the RAM as the initial values when the power supply is turned ON.

Refer to *16-3 DM Backup Function* for how to use DM Area words and bits.

### ● DM Fixed Allocation Words for the Modbus-RTU Easy Master

The following DM area words are used as command and response storage areas with the Modbus-RTU Easy Master function. These words are used for other applications if the Modbus-RTU Easy Master function is not served.

Refer to *14-4 Modbus-RTU Easy Master Function* for how to use the DM Area words and bits.

### ● Indirect Addressing of the DM Area

Indirect addressing can be used in the DM Area.

There are two modes that can be used.

#### Binary-mode Addressing (@D)

If a "@" symbol is input before a DM Area address, the contents of that DM Area word is treated as a hexadecimal (binary) address and the instruction will operate on the DM Area word at that address.

The entire DM Area can be indirectly addressed with hexadecimal values 0000 to 1FFF.

Example: @D0 

0100
------

 → D256 

--

  
Address actually used.

#### BCD-mode Addressing (\*D)

If a "\*" symbol is input before a DM Area address, the content of that DM Area word is treated as a BCD address and the instruction will operate on the DM Area word at that address.

Only part of the DM Area (D0 to D8192) can be indirectly addressed with BCD values 0 to 8192.

Example: \*D0 

0100
------

 → D100 

--

  
Address actually used.

## 5-6 Timer Area (T)

### Overview

The Timer Area contains Timer Completion Flags (1 bit each) and timer PVs (16 bits each). The Completion Flag is turned ON when a decremting timer PV reaches 0 (counting out) or an incrementing/decremting timer PV reaches the set value or 0.

### Notation

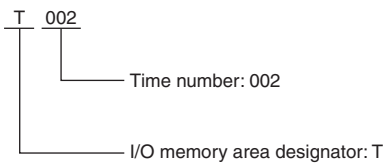

### Range

Timer numbers range from T0 to T255.

### Details

#### ● Types of Timers

The following table shows which instructions are used to refresh timer PVs in BCD and binary mode.

Timer instruction	BCD mode	Binary mode
HUNDRED-MS TIMER	TIM	TIMX
TEN-MS TIMER	TIMH	TIMHX
ONE-MS TIMER	TMHH	TMHHX
ACCUMULATIVE TIMER	TTIM	TTIMX

Timer numbers 0 to 255 are used by all timers listed above.

**Note** Only timer numbers 0 to 15 can be used in 1ms TIMER (TMHH/TMHHX).

#### ● Timer Example: Timer Number 0 and a Timer Set Value of 1 s

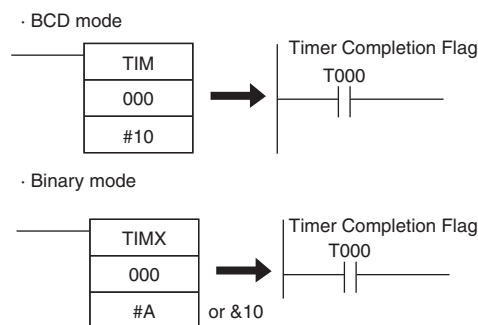

## ● Timer PV Refresh Method

Timer numbers	Timer PV refresh method
T0 to T255	<p>The timer PV is refreshed when the instruction is executed. This can cause a delay depending on the cycle time.</p> <ul style="list-style-type: none"> <li>When the cycle time is longer than 100 ms, delay is generated by the TIM/TIMX instruction.</li> <li>When the cycle time is longer than 10 ms, delay is generated by the TIMH/TIMHX instruction.</li> <li>When the cycle time is longer than 1 ms, delay is generated by the TMHH/TMHHX instruction.</li> </ul>



### Precautions for Correct Use

It is not recommended to use the same timers number in two timer instructions because the timers will not operate correctly if they are operating simultaneously.

Do not use the same timer number for more than one instruction.

If two or more timer instructions use the same timer number, an error will be generated during the program check.

## ● Resetting or Maintaining Timers

- Timer Completion Flags can be force-set and force-reset.
- Timer PVs cannot be force-set or force-reset, although the PVs can be refreshed indirectly by force-setting/resetting the Completion Flag.
- There are no restrictions in the order of using timer numbers or in the number of N.C. or N.O. conditions that can be programmed.
- Timer PVs can be read as word data and used in programming.
- The following table shows when timers will be reset or maintained.

Instruction	TIM/TIMX	TIMH/TIMHX	TMHH/TMHHX	TTIM/TTIMX
	HUNDRED-MS TIMER	TEN-MS TIMER	ONE-MS TIMER	ACCUMULATIVE TIMER
When the operating mode is changed between PROGRAM or MONITOR mode and RUN mode*1	PV=0 Flag=OFF			
When the PLC power is reset	PV=0 Flag=OFF			
CNR/CNRX instructions (timer/counter reset)*2	PV= 9999/FFFF Flag=OFF			
Jumps (JMP-JME)	Retained			
Interlocks (IL-ILC) with OFF interlock conditions	Reset (PV = SV, Timer Completion Flag = OFF)			Retained

\*1 If the IOM Hold Bit (A500.12) is ON, the PV and Completion Flag will be retained when a fatal error occurs (including execution of FALS instructions) or the operating mode is changed from PROGRAM mode to RUN or MONITOR mode or vice-versa. (The PV and Completion Flag will be cleared when power is cycled.)

\*2 Since the TIML/TIMLX instructions do not use timer numbers, they are reset under different conditions. The PV for a TIML/TIMLX instruction is reset to the SV. Refer to the descriptions of these instructions for details.

## 5-7 Counter Area (C)

### Overview

The Counter Area contains Completion Flags (1 bit each) and counter PVs (16 bits each). A Completion Flag is turned ON when the counter PV reaches the set value (counting out).



#### Precautions for Safe Use

With an E□□(S)-type CPU Unit or with an N/NA□□(S)-type CPU Unit without a Battery, the contents of the DM Area (D) \*, Holding Area (H), the Counter Present Values (C), the status of Counter Completion Flags (C), and the status of bits in the Auxiliary Area (A) related to clock functions may be unstable when the power supply is turned ON.

\* This does not apply to areas backed up to EEPROM using the DM backup function.

If the DM backup function is being used, be sure to refer to 3-2-4 *Initializing I/O Memory at Startup* for details.

### Notation

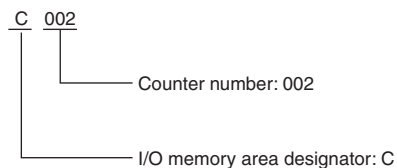

### Range

Counter numbers range from C0 to C255.

### Details

#### ● Types of Counters

The following table shows which instructions are used to refresh counter PVs in BCD and binary mode.

Counter instruction	BCD mode	Binary mode
COUNTER	CNT	CNTX
REVERSIBLE COUNTER	CNTR	CNTRX

Counter numbers 0 to 255 are used by all counters given above.

The refresh method for counter PVs can be set from the CX-Programmer to either BCD or binary.

Built-in high-speed counters 0 to 5 do not use counter numbers.



### Precautions for Correct Use

It is not recommended to use the same counter number in two counter instructions because the counters will not operate correctly if they are counting simultaneously.

If two or more counter instructions use the same counter number, an error will be generated during the program check.

### ● Counter Example: Counter Number 0 with a Counter Set Value of 10

· BCD mode

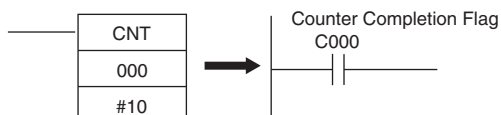

· Binary mode

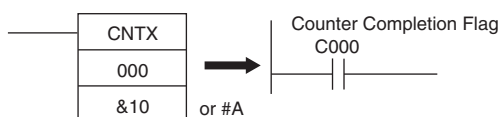

### ● Resetting or Maintaining Counter PVs

- Counter Completion Flags can be force-set and force-reset.
- Counter PVs cannot be force-set or force-reset, although the PVs can be refreshed indirectly by force-setting/resetting the Counter Completion Flag.
- There are no restrictions in the order of using counter numbers or in the number of N.C. or N.O. conditions that can be programmed.
- Counter PVs can be read as word data and used in programming.
- The following table shows when counters PVs are reset or maintained.

Instruction	CNT/CNTX	CNTR/CNTRX
	COUNTER	REVERSIBLE COUNTER
PV and Counter Completion Flag when counter is reset	PV=0 Counter Completion Flag = OFF	
When the operating mode is changed between PROGRAM or MONITOR mode and RUN mode	Retained	
When the PLC power is reset	Retained (Unstable when the battery is not mounted)	
Reset Input	Reset	
CNR/CNRX instructions	Reset	
Interlocks (IL-ILC) with OFF interlock conditions	Retained	

## 5-8 Auxiliary Area (A)

### Overview

The words and bits in this area have preassigned functions.

Refer to *A-2 Auxiliary Area Allocations by Address* for details.



#### Precautions for Safe Use

- With an E□□(S)-type CPU Unit or with an N/NA□□(S)-type CPU Unit without a Battery, the contents of the DM Area (D) \*, Holding Area (H), the Counter Present Values (C), the status of Counter Completion Flags (C), and the status of bits in the Auxiliary Area (A) related to clock functions may be unstable when the power supply is turned ON.  
\* This does not apply to areas backed up to EEPROM using the DM backup function.  
If the DM backup function is being used, be sure to refer to *3-2-4 Initializing I/O Memory at Startup* for details.
- Words in the Auxiliary Area related to clock function are unstable.

Bit/word	Name	Power interruption time		CPU Unit	
		Within I/O memory backup time	Longer than I/O memory backup time	E□□(S)-type CPU Unit	N/NA□□(S)-type CPU Unit
A100 to A199	Error Log Area	Retained	Unstable	Supported	Supported
A300	Error Log Pointer			Supported	
A351 to A354	Calendar/Clock Area			Not provided.	
A510 to A511	Startup Time			Not provided.	
A512 to A513	Power Interruption Time			Not provided.	
A514	Number of Power Interruptions			Supported	
A515 to A517	Operation Start Time			Not provided.	
A518 to A520	Operation End Time			Not provided.	
A720 to A749	Power ON Clock Data 1 to 10			Not provided.	

### Notation

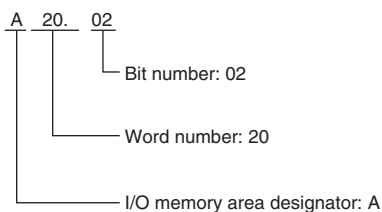

### Range

The Auxiliary Area contains 754 words with addresses ranging from A0 to A753.

## Applications

Applications of the bits and words in the Auxiliary Area are predefined. Ladder programs can be simplified and controllability can be improved by effectively using the bits and words in this area.

## Details

- Some words or bits are set automatically by the system and others are set and manipulated by the user.  
The Auxiliary Area includes error flags set by self-diagnosis, initial settings, control bits, and status data.
- Words and bits in this area can be read and written from the program or the CX-Programmer.
- The Auxiliary Area contains words that are read-only (A0 to A447) and words that can be read and written (A448 to A753).
- Even the read/write bits in the Auxiliary Area cannot be force-set and force-reset continuously.

### ● Auxiliary Area Words and Bits in the CX-Programmer's System-defined Symbols

The following table gives the Auxiliary Area bits and words pre-registered in the CX-Programmer's global symbol table as system-defined symbols.

Refer to *A-2 Auxiliary Area Allocations by Address* for details.

Word/Bit	Name	Name in CX-Programmer
A200.11	First Cycle Flag	P_First_Cycle
A200.12	Step Flag	P_Step
A200.15	First Cycle Task Flag	P_First_Cycle_Task
A262	Maximum Cycle Time	P_Max_Cycle_Time
A264	Present Cycle Time	P_Cycle_Time_Value
A401.08	Cycle Time Too Long Flag	P_Cycle_Time_Error
A402.04	Battery Error Flag	P_Low_Battery
A500.15	Output OFF Bit	P_Output_Off_Bit



## 5-9 Condition Flags

### Overview

These flags include the flags that indicate the results of instruction execution, as well as the Always ON and Always OFF Flags. These bits are specified with symbols rather than addresses.

The CX-Programmer treats condition flags as system-defined symbols (global symbols) beginning with P\_.

### Notation

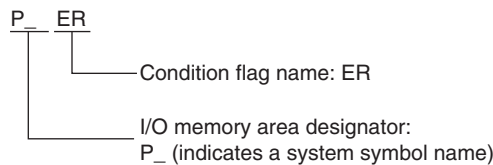

### Details

The Condition Flags are read-only; they cannot be written from instructions or from the CX-Programmer.

The Condition Flags cannot be force-set and force-reset.

#### ● Types of Condition Flags

Refer to *4-6 Ladder Programming Precautions* for details.

Name	Name in CX-Programmer	Function
Always ON Flag	P_On	Always ON.
Always OFF Flag	P_Off	Always OFF.
Error Flag	P_ER	Turned ON when the operand data in an instruction is incorrect (an instruction processing error) to indicate that an instruction ended because of an error. When the PLC Setup is set to stop operation for an instruction error (Instruction Error Operation), program execution will be stopped and the Instruction Processing Error Flag (A295.08) will be turned ON when the Error Flag is turned ON.
Access Error Flag	P_AER	Turned ON when an Illegal Access Error occurs. The Illegal Access Error indicates that an instruction attempted to access an area of memory that should not be accessed. When the PLC Setup is set to stop operation for an instruction error (Instruction Error Operation), program execution will be stopped and the Instruction Processing Error Flag (A4295.10) will be turned ON when the Access Error Flag is turned ON.
Carry Flag	P_CY	Turned ON when there is a carry in the result of an arithmetic operation or a 1 is shifted to the Carry Flag by a Data Shift instruction. The Carry Flag is part of the result of some Data Shift and Symbol Math instructions.
Greater Than Flag	P_GT	Turned ON when the first operand of a Comparison Instruction is greater than the second or a value exceeds a specified range.
Equals Flag	P_EQ	Turned ON when the two operands of a Comparison Instruction are equal or the result of a calculation is 0.

Name	Name in CX-Programmer	Function
Less Than Flag	P_LT	Turned ON when the first operand of a Comparison Instruction is less than the second or a value is below a specified range.
Negative Flag	P_N	Turned ON when the most significant bit of a result is ON.
Overflow Flag	P_OF	Turned ON when the result of calculation overflows the capacity of the result word(s).
Underflow Flag	P_UF	Turned ON when the result of calculation underflows the capacity of the result word(s).
Greater Than or Equals Flag	P_GE	Turned ON when the first operand of a Comparison Instruction is greater than or equal to the second.
Not Equal Flag	P_NE	Turned ON when the two operands of a Comparison Instruction are not equal.
Less than or Equals Flag	P_LE	Turned ON when the first operand of a Comparison Instruction is less than or equal to the second.

### ● Using the Condition Flags

The Condition Flags are shared by all of the instructions. Their status may change after each instruction execution in a single cycle.

Therefore, be sure to use Condition Flags on a branched output with the same execution condition immediately after an instruction to reflect the results of instruction execution.

Example: Using Instruction A Execution Results

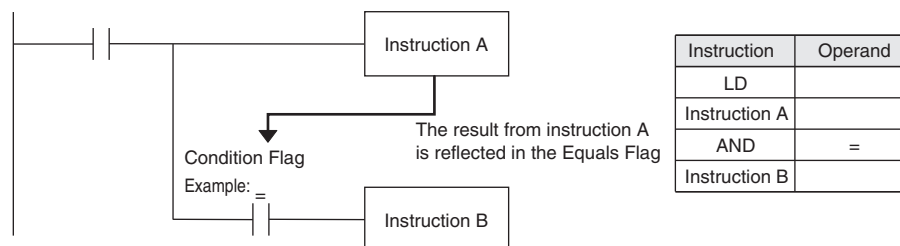

### Precautions for Correct Use

The Condition Flags are shared by all of the instructions. This means that program operation can be changed from its expected course by interruption of a single task. Be sure to consider the effects of interrupts when writing ladder programs to prevent unexpected operation.

## 5-10 Clock Pulses

### Overview

The Clock Pulses are turned ON and OFF by the CPU Unit's internal timer. These bits are specified with symbols rather than addresses.

The CX-Programmer treats condition flags as system-defined symbols (global symbols) beginning with P\_.

### Notation

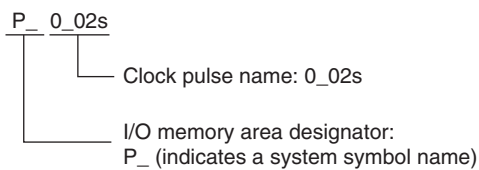

### Details

The Clock Pulses are read-only; they cannot be written from instructions or from the CX-Programmer.

#### ● Clock Pulses

Name	Name in CX-Programmer	Description
0.02-s Clock Pulse	P_0_02s	<p>ON for 0.01 s OFF for 0.01 s</p>
0.1-s clock pulse	P_0_1s	<p>ON for 0.05 s OFF for 0.05 s</p>
0.2-s clock pulse	P_0_2s	<p>ON for 0.1 s OFF for 0.1 s</p>
1-s clock pulse	P_1s	<p>ON for 0.5 s OFF for 0.5 s</p>
1-min clock pulse	P_1min	<p>ON for 30 s OFF for 30 s</p>

● **Using the Clock Pulses**

The following example turns a bit ON and OFF at 0.5-s intervals.

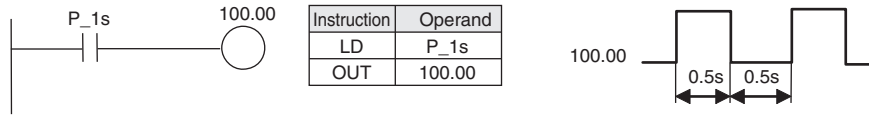



# I/O Allocation

This section describes I/O allocation used to exchange data between the CP1E CPU Unit and other units.  
Be sure you understand the information in the section before attempting to write ladder diagrams.

---

<b>6-1</b>	<b>Allocation of Input Bits and Output Bits</b>	<b>6-2</b>
6-1-1	I/O Allocation	6-2
6-1-2	I/O Allocation Concepts	6-3
6-1-3	Allocations on the CPU Unit	6-3
6-1-4	Allocations to Expansion Units and Expansion I/O Units	6-4

# 6-1 Allocation of Input Bits and Output Bits

This section describes the allocation of input bits and output bits.

## 6-1-1 I/O Allocation

OMRON calls allocating I/O bits in memory “I/O allocation.”

The I/O on Expansion I/O Units are allocated I/O bits in the words following the allocated words to the built-in I/O on the CPU Units.

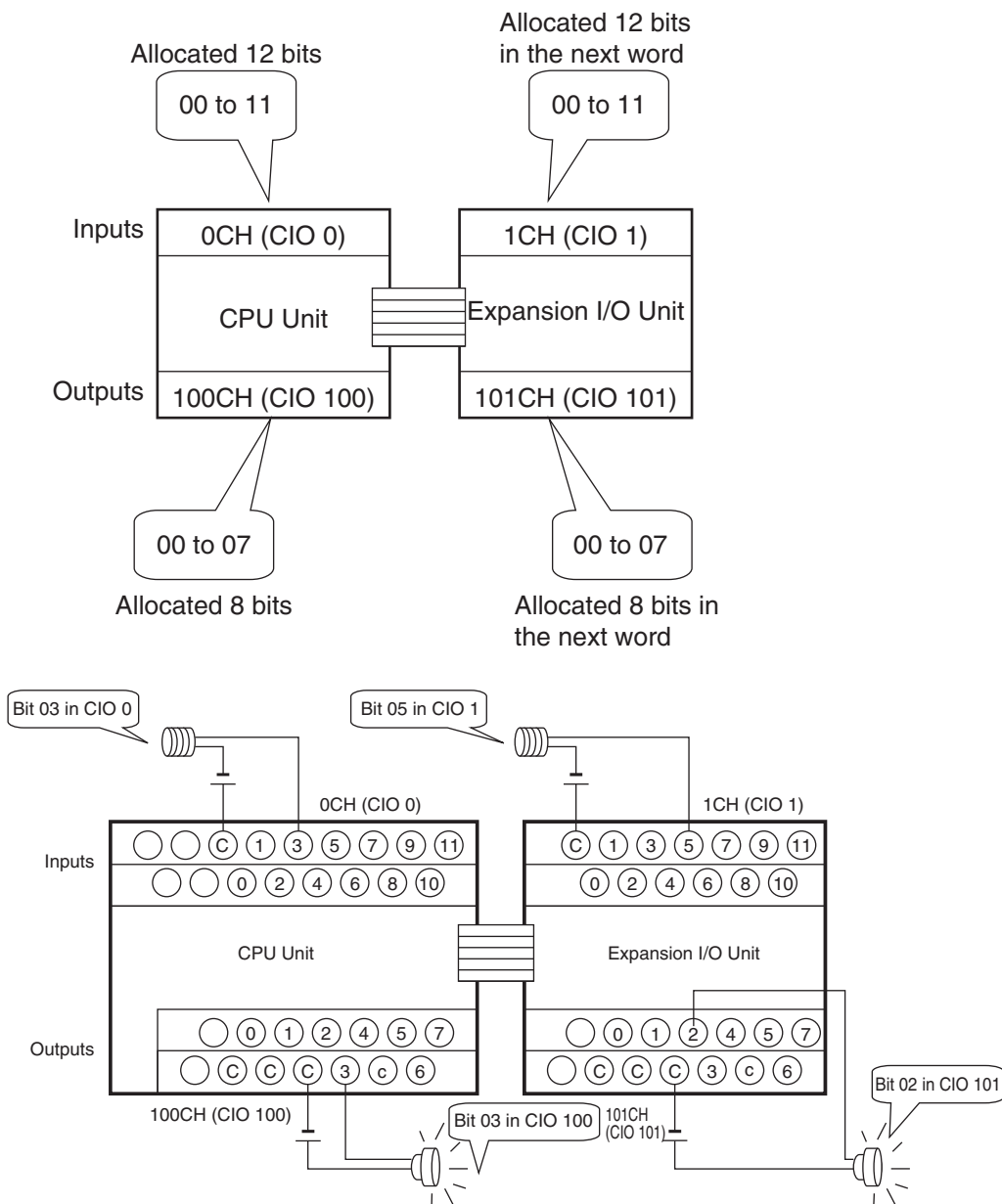

## 6-1-2 I/O Allocation Concepts

The CPU Unit automatically allocates I/O bits to the Expansion I/O Units and Expansion Units, if connected when the power supply is turned ON.

It is not necessary to specify I/O bits allocation.

## 6-1-3 Allocations on the CPU Unit

### ● Input bits are allocated from CIO 0 and output bits are allocated from CIO 100

The first word from which input bits are allocated is CIO 0. The first word from which output bits are allocated is CIO 100. These cannot be changed.

### ● Words Allocated by the System and the Number of Connected Units

The starting words for inputs and outputs are predetermined for a CP1E CPU Unit. Input bits in CIO 0, or CIO 0 and CIO 1, and output bits in CIO 100, or CIO 100 and CIO 101, are automatically allocated to the built-in I/O on the CPU Unit.

The words from which bits are allocated by the system and the number of Expansion I/O Units and Expansion Units that can be connected are given in the following table.

CPU Unit	Allocated words		Number of Expansion Units and Expansion I/O Units connected
	Input Bits	Output Bits	
E10/14/20 or N14/20 CPU Unit	CIO 0	CIO 100	0 Unit
E30/40 or N30/40 CPU Unit	CIO 0 and CIO 1	CIO 100 and CIO 101	3 Units
N60 CPU Unit	CIO 0, CIO 1 and CIO 2	CIO 100, CIO 101 and CIO 102	3 Units
NA20 CPU Unit	CIO 0, CIO 90 and CIO 91	CIO 100 and CIO 190	3 Units

### ● Application Example: CPU Unit with 40 I/O Points

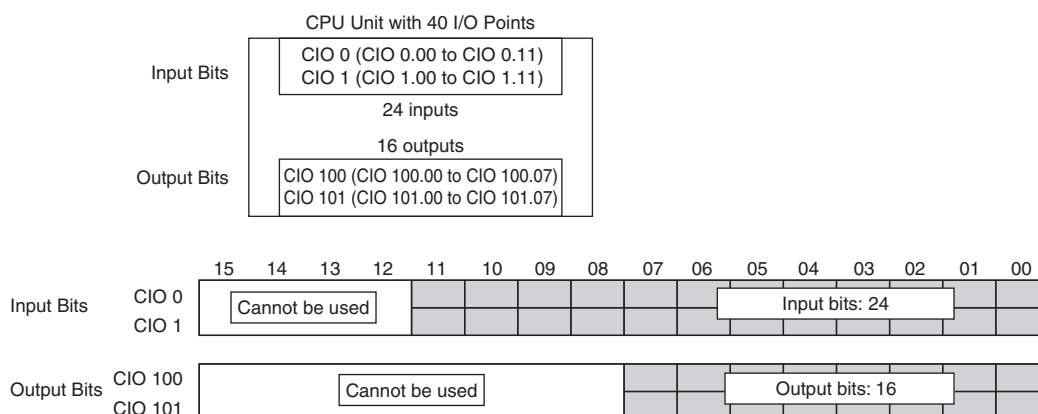

For a CPU Unit with 40 I/O points, a total of 24 input bits are allocated to the input terminal block. The bits that are allocated are input bits CIO 0.00 to CIO 0.11 (i.e., bits 00 to 11 in CIO 0) and input bits CIO 1.00 to CIO 1.11 (i.e., bits 00 to 11 in CIO 1).

In addition, a total of 16 output bits are allocated to the output terminal block. The bits that are allocated are output bits CIO 100.00 to CIO 100.07 (i.e., bits 00 to 07 in CIO 0) and output bits CIO 101.00 to CIO 101.07 (i.e., bits 00 to 07 in CIO 1).

## 6-1-4 Allocations to Expansion Units and Expansion I/O Units

Expansion Units and Expansion I/O Units connected to the CPU Unit are automatically allocated input bits and output bits in words following those allocated to the CPU Unit.

For example, if a CPU Unit with 40 I/O points is used, CIO 0 and CIO 1 are allocated for inputs and CIO 100 and CIO 101 are allocated for outputs. Thus, words from CIO 2 onward for inputs and words from CIO 102 onward for outputs are automatically allocated to the Expansion I/O Units and Expansion Units in the order that the Units are connected.

### Allocations to Expansion I/O Units

There are Expansion I/O Units for expanding inputs, for expanding outputs, and for expanding both input and outputs.

I/O bits starting from bit 00 in the next word after the word allocated to the previous Expansion Unit, Expansion I/O Unit, or CPU Unit are automatically allocated. This word is indicated as “CIO m” for input words and as “CIO n” for output words.

Model		Input bits			Output bits			
		No. of bits	No. of words	Addresses	No. of bits	No. of words	Addresses	
8-point Input Unit		CP1W-8ED	8	1	CIO m, bits 00 to 07	–	None	None
8-point Output Unit	Relay outputs	CP1W-8ER	–	None	None	8	1	CIO n, bits 00 to 07
	Sinking transistor outputs	CP1W-8ET						
	Sourcing transistor outputs	CP1W-8ET1						
16-point Output Unit	Relay outputs	CP1W-16ER	–	None	None	16	2	CIO n, bits 00 to 07 CIO n+1, bits 00 to 07
	Sinking transistor outputs	CP1W-16ET						
	Sourcing transistor outputs	CP1W-16ET1						
20-point I/O Units	Relay outputs	CP1W-20EDR1	12	1	CIO m, bits 00 to 11	8	1	CIO n, bits 00 to 07
	Sinking transistor outputs	CP1W-20EDT						
	Sourcing transistor outputs	CP1W-20EDT1						
32-point Output Unit	Relay outputs	CP1W-32ER	–	None	None	32	4	CIO n, bits 00 to 07 CIO n+1, bits 00 to 07 CIO n+2, bits 00 to 07 CIO n+3, bits 00 to 07
	Sinking transistor outputs	CP1W-32ET						
	Sourcing transistor outputs	CP1W-32ET1						
40-point I/O Unit	Relay outputs	CP1W-40EDR	24	2	CIO m, bits 00 to 11 CIO m+1, bits 00 to 11	16	2	CIO n, bits 00 to 07 CIO n+1, bits 00 to 07
	Sinking transistor outputs	CP1W-40EDT						
	Sourcing transistor outputs	CP1W-40EDT1						



● I/O Bits Allocation with Expansion I/O Units Connected

**Allocation Example: Expansion I/O Unit with 40 I/O Points (CP1W-40ED□)**

Twenty-four input bits in two words are allocated (bits 00 to 11 in CIO m and bits 00 to 11 CIO m+1). Sixteen output bits in two words are allocated in two words (bits 00 to 07 in CIO n and bits 00 to 07 in CIO n+1).

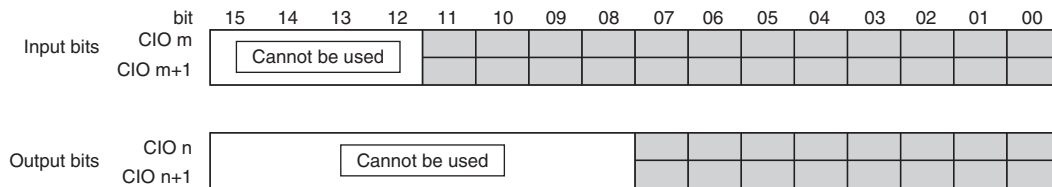

Two input words (24 bits) and two output words (16 bits) are allocated to a 40-point I/O Unit.

**Allocation Example: Expansion Input Units and Expansion Output Units**

If Expansion Input Units or Expansion Output Units are connected, the input or output word not used by an Expansion I/O Unit is allocated to the next Unit that requires it.

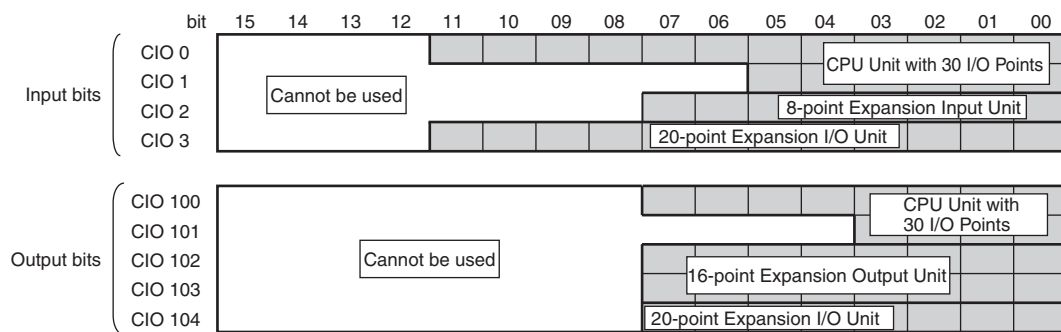
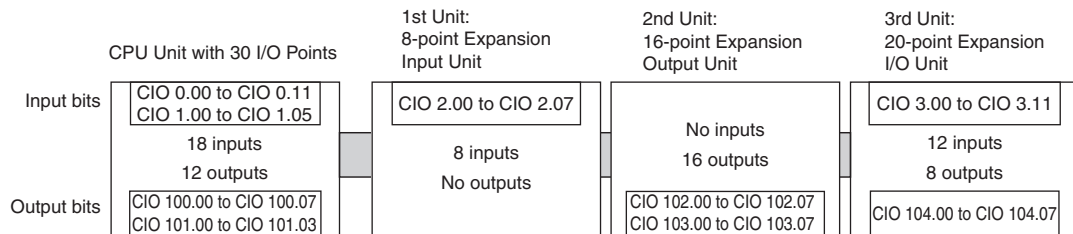

## Allocations for Expansion Units

### ● I/O Word Allocations to Expansion Units

m: Indicates the next input word after the input word allocated to the Expansion Unit, Expansion I/O Unit, or CPU Unit connected to the left of the current Unit.

n: Indicates the next output word after the output word allocated to the Expansion Unit, Expansion I/O Unit, or CPU Unit connected to the left of the current Unit.

Name	Model number	Input words		Output words	
		No. of words	Addresses	No. of words	Addresses
Analog I/O Unit	CP1W-MAD11	2 words	CIO m to m+1	1 word	CIO n
	CP1W-MAD42	4 words	CIO m to m+3	2 word	CIO n to CIO n+1
	CP1W-MAD44	4 words	CIO m to m+3	4 word	CIO n to CIO n+3
Analog Input Unit	CP1W-AD041	4 words	CIO m to m+3	2 words	CIO n to CIO n+1
	CP1W-AD042	4 words	CIO m to m+3	2 words	CIO n to CIO n+1
Analog Output Unit	CP1W-DA021	None	–	2 words	CIO n to CIO n+1
	CP1W-DA041	None	–	4 words	CIO n to CIO n+3
	CP1W-DA042	None	–	4 words	CIO n to CIO n+3
Temperature Sensor Units	CP1W-TS001	2 words	CIO m to m+1	None	–
	CP1W-TS002	4 words	CIO m to m+3	None	–
	CP1W-TS003	4 words	CIO m to m+3	None	–
	CP1W-TS004	2 words	CIO m to m+1	1 word	CIO n
	CP1W-TS101	2 words	CIO m to m+1	None	–
	CP1W-TS102	4 words	CIO m to m+3	None	–
CompoBus/S I/O Link Unit	CP1W-SRT21	1 word	CIO m	1 word	CIO n

● I/O Word Allocations to Expansion Units

**Allocation Example: CPU Unit with 40 I/O Points + Temperature Sensor Unit (TS002) + Analog Output Unit (DA041) + Expansion I/O Unit with 40 I/O points**

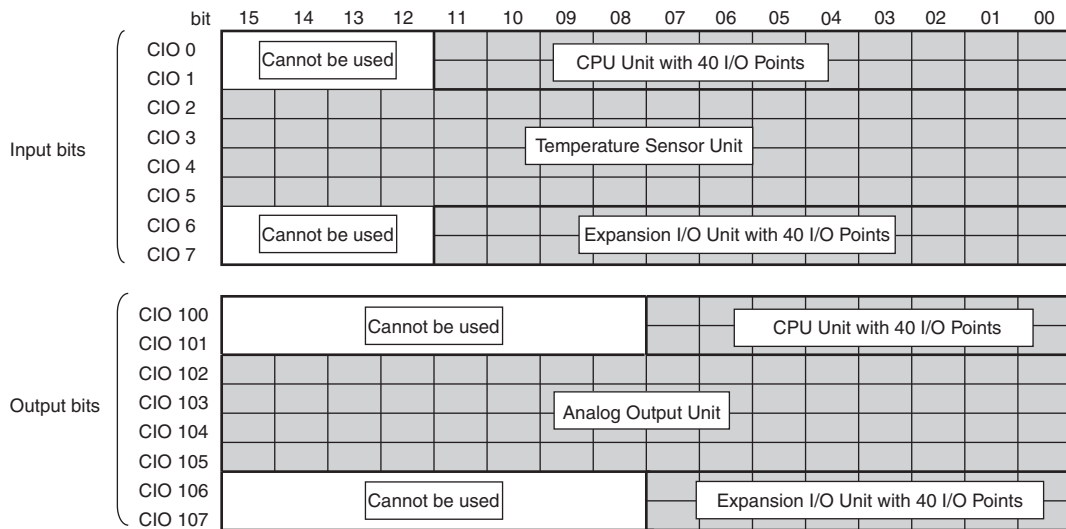
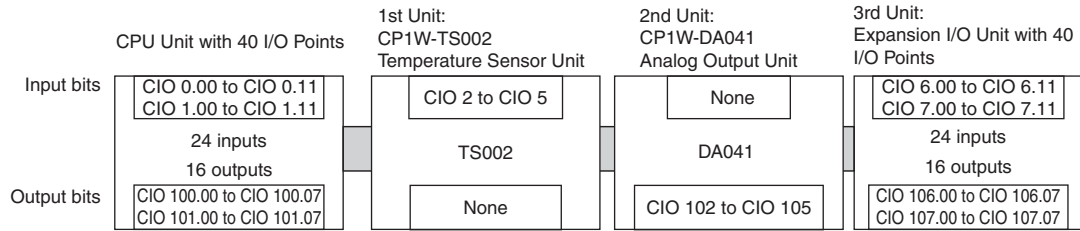





# PLC Setup

This section describes the parameters in the PLC Setup, which are used to make basic settings for the CP1E CPU Unit.

---

<b>7-1</b>	<b>Overview of the PLC Setup</b>	<b>7-2</b>
<b>7-2</b>	<b>PLC Setup Settings</b>	<b>7-3</b>
7-2-1	Startup and CPU Unit Settings	7-3
7-2-2	Timing and Interrupt Settings	7-3
7-2-3	Input Constant Settings	7-4
7-2-4	Built-in RS-232C Port	7-5
7-2-5	Serial Option Port / Built-in RS-485 Port	7-8
7-2-6	Built-in Inputs	7-11
7-2-7	Pulse Output 0 Settings	7-13
7-2-8	Pulse Output 1 Settings	7-14
7-2-9	Built-in AD/DA: Built-in Analog I/O Settings	7-16

# 7-1 Overview of the PLC Setup

The PLC Setup contains basic CPU Unit software parameter settings that the user can change to customize PLC operation.

These settings can be changed from a CX-Programmer. Change the PLC Setup in the following case. There is no need to reset, if the default (initial) settings are correct.

The setting from the CX-Programmer are saved to the built-in EEPROM backup memory.

Application	Parameter
Reading the DM area words saved to the backup memory when power is turned ON.	Startup Data Read
Changing the Startup Mode to PROGRAM or MONITOR mode when debugging.	Startup Mode
Detection of low-battery errors is not required when using battery-free operation.	Detect Low Battery
Finding instruction errors when debugging.	Stop CPU on Instruction Error
A minimum cycle time setting to create a consistent I/O refresh cycle.	Minimum Cycle Time
Setting a watch cycle time.	Watch Cycle Time
Recording user-defined errors for FAL in the error log is not required.	FAL Error Log Registration

## ● Related Auxiliary Area Flags

Name	Word	Description	Read/write
PLC Setup Error Flag (Non-fatal error)	A402.10	ON when there is a setting error in the PLC Setup.	Read only

## ● Setting Methods for the PLC Setup

Set using the CX-Programmer

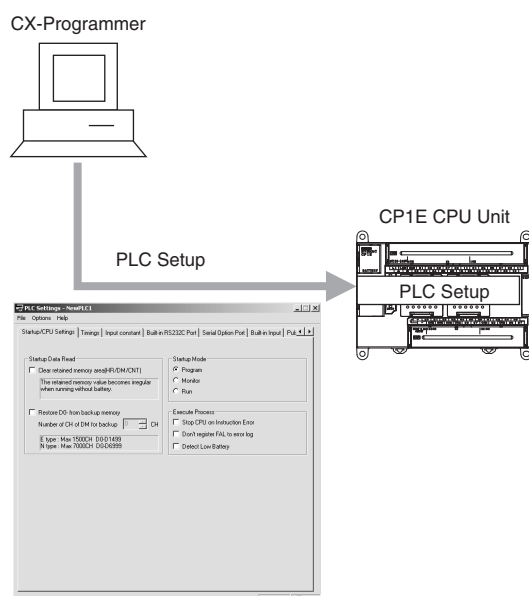

## 7-2 PLC Setup Settings

### 7-2-1 Startup and CPU Unit Settings

#### Startup Data Read Setting

	Name	Default	Possible settings	When setting is read by CPU Unit
1	Clear Held Memory (HR/DM/CNT) to Zero	Do not clear.	Do not clear. Clear.	When power is turned ON
2	Read D0- from backup memory	Do not read.	Do not read. Read.	When power is turned ON
3	Number of CH of DM for backup	0	E□□(S)-type CPU Unit: 0 to 1,499 N/NA□□(S)-type CPU Unit: 0 to 6,999	When power is turned ON

#### Startup Mode Setting

	Name	Default	Possible settings	When setting is read by CPU Unit
1	Startup Mode Setting	Run: RUN mode	Program: PROGRAM mode Monitor: MONITOR mode Run: RUN mode	When power is turned ON

#### Execute Process Settings

	Name	Default	Possible settings	When setting is read by CPU Unit
1	Stop CPU on Instruction Error	Do not stop.	Do not stop. Stop.	At start of operation
2	Don't register FAL to error log	Register.	Register. Do not register.	When power is turned ON
3	Do not detect Low Battery (N/NA□□(S)-type CPU Unit only)	Do not detect.	Do not detect. Detect.	Every cycle

### 7-2-2 Timing and Interrupt Settings

#### Timing and Interrupt Settings

	Name	Default	Possible settings	When setting is read by CPU Unit
1	Watch Cycle Time	1 s	Other than initial setting (any) 1ms : 1,000 ms	At start of operation
2	Constant Cycle Time	No setting (variable)	Setting 1ms : 1,000 ms	At start of operation

## 7-2-3 Input Constant Settings

## Input Constants

	Name	Default	Possible settings	When setting is read by CPU Unit
1	0CH: CIO 0	8 ms	No filter (0 ms) 1 ms 2 ms 4 ms 8 ms 16 ms 32 ms	When power is turned ON
2	1CH: CIO 1	Same as above.	Same as above.	Same as above.
3	2CH: CIO 2			
4	3CH: CIO 3			
5	4CH: CIO 4			
6	5CH: CIO 5			
7	6CH: CIO 6			
8	7CH: CIO 7			
9	8CH: CIO 8			
10	9CH: CIO 9			
11	10CH: CIO 10			
12	11CH: CIO 11			
13	12CH: CIO 12			
14	13CH: CIO 13			
15	14CH: CIO 14			
16	15CH: CIO 15			
17	16CH: CIO 16			
18	17CH: CIO 17			

**Note** The input constants of CP1W-40EDR/EDT/EDT1 are always 16ms regardless of the settings.



## 7-2-4 Built-in RS-232C Port

The settings are applicable to the N/NA□□(S)-type CPU Units.

Since this setting is reflected by power OFF and ON, the PLC Setup and the actual operation settings may be different. The actual operation settings can be confirmed in words A617/A618.

### Communications Settings

	Name		Default	Possible settings	When setting is read by CPU Unit
1	Communications Settings		Standard (9,600; 1, 7, 2, E) (Default settings)	Standard Baud rate: 9,600 bps Start bits: 1 bit Data length: 7 bits Parity: Even Stop bits: 2 bits Host Link Custom	When power is turned ON
2	Mode (When custom settings have been selected.)		Host Link	Host Link NT Link (1:N): 1:N NT Links RS-232C (No-protocol) PC Link (Slave) PC Link (Master) Modbus-RTU Easy Master	When power is turned ON
2-1	Host Link Settings				
	2-1-1	Baud	9,600 bps	1,200 bps 2,400 bps 4,800 bps 9,600 bps 19,200 bps 38,400 bps 57,600 bps 115,200 bps	When power is turned ON
	2-1-2	Format (data length, stop bits, parity)	7 bits, 2 bits, even	7 bits, 2 bits, even 7 bits, 2 bits, odd 7 bits, 2 bits, no parity 7 bits, 1 bit, even 7 bits, 1 bit, odd 7 bits, 1 bit, no parity 8 bits, 2 bits, even 8 bits, 2 bits, odd 8 bits, 2 bits, no parity 8 bits, 1 bit, even 8 bits, 1 bit, odd 8 bits, 1 bit, no parity	When power is turned ON
	2-1-3	Unit Number	0	0 : 31	When power is turned ON
2-2	NT Link (1:N) Settings				
	2-2-1	Baud	115,200 bps	38,400 bps (standard) 115,200 bps (high speed)	When power is turned ON
	2-2-2	No.NT/PC Link Max. (Highest unit number of PT that can be connected to the PLC)	1	0 : 7	When power is turned ON

	Name	Default	Possible settings	When setting is read by CPU Unit	
2	2-3 RS-232C (No-protocol) Settings				
	2-3-1	Baud	9,600 bps	1,200 bps	When power is turned ON
				2,400 bps	
				4,800 bps	
				9,600 bps	
				19,200 bps	
				38,400 bps	
				57,600 bps	
				115,200 bps	
	2-3-2	Format (data length, stop bits, parity)	7 bits, 2 bits, even	7 bits, 2 bits, even	When power is turned ON
				7 bits, 2 bits, odd	
				7 bits, 2 bits, no parity	
				7 bits, 1 bit, even	
				7 bits, 1 bit, odd	
				7 bits, 1 bit, no parity	
8 bits, 2 bits, even					
8 bits, 2 bits, odd					
8 bits, 2 bits, no parity					
8 bits, 1 bit, even					
8 bits, 1 bit, odd					
8 bits, 1 bit, no parity					
2-3-3	Start Code	Disable.	Disable. Set.	When power is turned ON	
2-3-4	Start Code (setting)	00 Hex	00 Hex : FF hex	When power is turned ON	
2-3-5	End Code	None (Received Bytes)	Received Bytes (no end code) CR, LF Set End Code	When power is turned ON	
2-3-6	Received Bytes (setting)	256 bytes	256 bytes 1 byte : 255 bytes	When power is turned ON	
2-3-7	Set End Code (setting)	00 Hex	00 Hex : FF Hex	When power is turned ON	
2-3-8	Delay	0 ms	0 (x10 ms) : 9999 (x10 ms)	When power is turned ON	
2-5	Modbus-RTU Easy Master Settings				
	2-5-1	Baud	9,600 bps	1,200 bps	When power is turned ON
				2,400 bps	
				4,800 bps	
				9,600 bps	
				19,200 bps	
				38,400 bps	
				57,600 bps	
				115,200 bps	

		Name	Default	Possible settings	When setting is read by CPU Unit	
2	2-5	2-5-2	Format (data length, stop bits, parity)	7 bits, 2 bits, even	7 bits, 2 bits, even	When power is turned ON
				7 bits, 2 bits, odd	7 bits, 2 bits, odd	
				7 bits, 2 bits, no parity	7 bits, 2 bits, no parity	
				7 bits, 1 bit, even	7 bits, 1 bit, even	
				7 bits, 1 bit, odd	7 bits, 1 bit, odd	
				7 bits, 1 bit, no parity	7 bits, 1 bit, no parity	
				8 bits, 2 bits, even	8 bits, 2 bits, even	
				8 bits, 2 bits, odd	8 bits, 2 bits, odd	
				8 bits, 2 bits, no parity	8 bits, 2 bits, no parity	
				8 bits, 1 bit, even	8 bits, 1 bit, even	
				8 bits, 1 bit, odd	8 bits, 1 bit, odd	
		8 bits, 1 bit, no parity	8 bits, 1 bit, no parity			
		2-5-3	Response Timeout	5 s	5 s	When power is turned ON
					1 (×100 ms)	
			:			
			255 (×100 ms)			
2-6	PC Link (Slave) Settings					
2-6-1	Baud	9,600 bps	1,200 bps	When power is turned ON		
			2,400 bps			
			4,800 bps			
			9,600 bps			
			19,200 bps			
			38,400 bps			
			57,600 bps			
115,200 bps						
2-6-2	PLC Link Unit No.	0	0	When power is turned ON		
			:			
			7			
2-7	PC Link (Master) Settings					
2-7-1	Baud	9,600 bps	1,200 bps	When power is turned ON		
			2,400 bps			
			4,800 bps			
			9,600 bps			
			19,200 bps			
			38,400 bps			
			57,600 bps			
115,200 bps						
2-7-2	Link Words	10 Words	1 word	When power is turned ON		
			:			
			10 words			
2-7-3	PC Link Mode	ALL	ALL	When power is turned ON		
			Masters			
2-7-4	No.NT/PC Link Max. (Highest unit number of PT that can be connected to the PLC)	1	0	When power is turned ON		
			:			
			7			

## 7-2-5 Serial Option Port / Built-in RS-485 Port

The settings are applicable to the serial option ports mounting on N30/40/60 or NA20 CPU Units, or the built-in RS-485 ports on N30/40/60S1 CPU Units.

Since this setting is reflected by power OFF and ON, the PLC Setup and the actual operation settings may be different. The actual operation settings can be confirmed in words A617/A618.

**Note** The built-in RS-485 port of the N30/40/60S1 CPU Unit should be set in the Serial Option Port tab of the PLC Setup using the CX-Programmer.

### Communications Settings

	Name	Default	Possible settings	When setting is read by CPU Unit	
1	Communications Settings	Standard (9600; 1, 7, 2, E) (Default settings)	Standard Baud rate: 9,600 bps Start bits: 1 bit Data length: 7 bits Parity: Even Stop bits: 2 bits Custom	When power is turned ON	
2	Mode	Host Link	Host Link NT Link (1:N): 1:N NT Links RS-232C (No-protocol) PC Link (Slave) PC Link (Master) Modbus-RTU Easy Master	When power is turned ON	
2-1	Host Link Settings				
	2-1-1	Baud	9,600 bps	1,200 bps 2,400 bps 4,800 bps 9,600 bps 19,200 bps 38,400 bps 57,600 bps 115,200 bps	When power is turned ON
	2-1-2	Format (data length, stop bits, parity)	7 bits, 2 bits, even	7 bits, 2 bits, even 7 bits, 2 bits, odd 7 bits, 2 bits, no parity 7 bits, 1 bit, even 7 bits, 1 bit, odd 7 bits, 1 bit, no parity 8 bits, 2 bits, even 8 bits, 2 bits, odd 8 bits, 2 bits, no parity 8 bits, 1 bit, even 8 bits, 1 bit, odd 8 bits, 1 bit, no parity	When power is turned ON
	2-1-3	Unit Number	0	0 : 31	When power is turned ON
2-2	NT Link (1:N) Settings				
	2-2-1	Baud	115,200 bps	38,400 bps (standard) 115,200 bps (high speed)	When power is turned ON
	2-2-2	No. NT/PC Link Max. (Highest unit number of PT that can be connected to the PLC)	1	0 : 7	When power is turned ON

		Name	Default	Possible settings	When setting is read by CPU Unit	
2	2-3	RS-232C (No-protocol) Settings				
	2-3-1	Baud	9,600 bps	1,200 bps 2,400 bps 4,800 bps 9,600 bps 19,200 bps 38,400 bps 57,600 bps 115,200 bps	When power is turned ON	
	2-3-2	Format (data length, stop bits, parity)	7 bits, 2 bits, even	7 bits, 2 bits, even 7 bits, 2 bits, odd 7 bits, 2 bits, no parity 7 bits, 1 bit, even 7 bits, 1 bit, odd 7 bits, 1 bit, no parity 8 bits, 2 bits, even 8 bits, 2 bits, odd 8 bits, 2 bits, no parity 8 bits, 1 bit, even 8 bits, 1 bit, odd 8 bits, 1 bit, no parity	When power is turned ON	
	2-3-3	Start Code	Disable.	Disable. Set.	When power is turned ON	
	2-3-4	Start Code (setting)	00 hex	00 hex : FF hex	When power is turned ON	
	2-3-5	End Code	None (Received Bytes)	Received Bytes (no end code) CR, LF Set End Code	When power is turned ON	
	2-3-6	Received Bytes (setting)	256 bytes	256 bytes 1 byte : 255 bytes	When power is turned ON	
	2-3-7	Set End Code (setting)	00 hex	00 hex : FF hex	When power is turned ON	
	2-3-8	Delay	0 ms	0 (x10 ms) : 9999 (x10 ms)	When power is turned ON	
	2-5	Modbus-RTU Easy Master Settings				
	2-5-1	Baud	9,600 bps	1,200 bps 2,400 bps 4,800 bps 9,600 bps 19,200 bps 38,400 bps 57,600 bps 115,200 bps	When power is turned ON	

	Name		Default	Possible settings	When setting is read by CPU Unit	
2	2-5	2-5-2	Format (data length, stop bits, parity)	7 bits, 2 bits, even	7 bits, 2 bits, even	When power is turned ON
					7 bits, 2 bits, odd	
					7 bits, 2 bits, no parity	
					7 bits, 1 bit, even	
					7 bits, 1 bit, odd	
					7 bits, 1 bit, no parity	
					8 bits, 2 bits, even	
					8 bits, 2 bits, odd	
					8 bits, 2 bits, no parity	
					8 bits, 1 bit, even	
	8 bits, 1 bit, odd					
	8 bits, 1 bit, no parity					
	2-5	2-5-3	Response Timeout	5 s	5 s	When power is turned ON
					1 (×100 ms)	
:						
255 (×100 ms)						
2-6	PC Link (Slave) Settings				When power is turned ON	
	2-6-1	Baud	9,600 bps	1,200 bps		
				2,400 bps		
				4,800 bps		
				9,600 bps		
				19,200 bps		
				38,400 bps		
				57,600 bps		
				115,200 bps		
	2-6-2	PLC Link Unit No.	0	0		
7						
2-7	PC Link (Master) Settings				When power is turned ON	
	2-7-1	Baud	9,600 bps	1,200 bps		
				2,400 bps		
				4,800 bps		
				9,600 bps		
				19,200 bps		
				38,400 bps		
				57,600 bps		
				115,200 bps		
	2-7-2	Link Words	10 words	1 word		
10 words						
2-7-3	PC Link Mode	ALL	ALL			
			Masters			
2-7-4	No. NT/PC Link Max. (Highest unit number of PT that can be connected to the PLC)	1	0			
			:			
			7			

## 7-2-6 Built-in Inputs

## High-speed Counter Settings

	Name		Default	Possible settings	When setting is read by CPU Unit		
1	Use high-speed counter 0		Do not use.	Do not use. Use.	When power is turned ON		
	1-1	Counting mode	Linear mode	Linear mode Circular mode	At start of operation		
		1-1-1	Circular Max. Count	0	0 : 4,294,967,295	At start of operation	
	1-2	Reset <b>Note</b> Only a software reset can be set if an increment pulse input is set for the input setting.		Z phase, software reset (stop comparing)	Z phase, software reset (stop comparing) Software reset (stop comparing) Phase Z, software reset (comparing) Software reset (comparing)	When power is turned ON	
		1-3	Input Setting <b>Note</b> Make the same input setting for high-speed counters 0, 1, and 2.		Differential phase input (x4)	Differential phase input (x4) Pulse + direction input Up/Down pulse input Increment pulse input	When power is turned ON
			Use high-speed counter 1		Do not use.	Do not use. Use.	When power is turned ON
			2-1	Counting mode	Linear mode	Linear mode Circular mode	At start of operation
	2-1-1			Circular Max. Count	0	0 : 4,294,967,295	At start of operation
	2-2	Reset <b>Note</b> Only a software reset can be set if an increment pulse input is set for the input setting.		Z phase, software reset (stop comparing)	Z phase, software reset (stop comparing) Software reset (stop comparing) Phase Z, software reset (comparing) Software reset (comparing)	When power is turned ON	
		2-3	Input Setting <b>Note</b> Make the same input setting for high-speed counters 0, 1, and 2.		Differential phase input (x4)	Differential phase input (x4) Pulse + direction input Up/Down pulse input Increment Pulse input	When power is turned ON
Use high-speed counter 2			Do not use.	Do not use. Use.	When power is turned ON		
3-1			Counting mode	Linear mode	Linear mode Circular mode	At start of operation	
	3-1-1		Circular Max. Count	0	0 : 4,294,967,295	At start of operation	
3-2	Reset		Software reset	Software reset Software reset (comparing)	When power is turned ON		
	3-3		Input Setting	Increment pulse input	Increment pulse input	When power is turned ON	

	Name		Default	Possible settings	When setting is read by CPU Unit
4	Use high-speed counter 3		Do not use.	Do not use. Use.	When power is turned ON
	4-1	Counting mode	Linear mode	Linear mode	At start of operation
				Circular mode	
	4-1-1	Circular Max. Count	0	0	At start of operation
				:	
4,294,967,295					
4-2	Reset	Software reset	Software reset Software reset (comparing)	When power is turned ON	
4-3	Input Setting	Increment pulse input	Increment pulse input	When power is turned ON	
5	Use high-speed counter 4		Do not use.	Do not use. Use.	When power is turned ON
	5-1	Counting mode	Linear mode	Linear mode	At start of operation
				Circular mode	
	5-1-1	Circular Max. Count	0	0	At start of operation
				:	
4,294,967,295					
5-2	Reset	Software reset	Software reset Software reset (comparing)	When power is turned ON	
5-3	Input Setting	Increment pulse input	Increment pulse input	When power is turned ON	
6	Use high-speed counter 5		Do not use.	Do not use. Use.	When power is turned ON
	6-1	Counting mode	Linear mode	Linear mode	At start of operation
				Circular mode	
	6-1-1	Circular Max. Count	0	0	At start of operation
				:	
4,294,967,295					
6-2	Reset	Software reset	Software reset Software reset (comparing)	When power is turned ON	
6-3	Input Setting	Increment pulse input	Increment pulse input	When power is turned ON	

## Interrupt Input Settings

	Name	Default	Possible settings	When setting is read by CPU Unit
1	IN2: CIO 0.02	Normal	Normal	When power is turned ON
			Interrupt	
			Quick	
2	IN3: CIO 0.03	Normal	Normal	When power is turned ON
			Interrupt	
			Quick	
3	IN4: CIO 0.04	Normal	Normal	When power is turned ON
			Interrupt	
			Quick	
4	IN5: CIO 0.05	Normal	Normal	When power is turned ON
			Interrupt	
			Quick	
5	IN6: CIO 0.06	Normal	Normal	When power is turned ON
			Interrupt	
			Quick	
6	IN7: CIO 0.07	Normal	Normal	When power is turned ON
			Interrupt	
			Quick	



## 7-2-7 Pulse Output 0 Settings

The settings are applicable to the N/NA□□(S)-type CPU Units with transistor outputs.

### Base Settings

	Name	Default	Possible settings	When setting is read by CPU Unit
1	Undefined Origin (operation for limit signal turning ON)	Hold	Hold Undefined	At start of operation
2	Limit Input Signal Operation	Search Only	Search Only Always	When power is turned ON
3	Limit Input Signal	NC	NC NO	At start of operation
4	Search/Return Initial Speed	0 pps	0 pps : 100,000 pps	At start of operation

### Origin Search Settings

	Name	Default	Possible settings	When setting is read by CPU Unit
1	Use define origin operation	Do not use.	Do not use. Use.	When power is turned ON
1-1	Search Direction	CW	CW CCW	At start of operation
1-2	Detection Method	Method 0	Method 0 Method 1 Method 2	At start of operation
1-3	Search Operation	Inverse 1	Inverse 1 Inverse 2	At start of operation
1-4	Operation Mode	Mode 0	Mode 0 Mode 1 Mode 2	At start of operation
1-5	Origin Input Signal	NC	NC NO	At start of operation
1-6	Proximity Input Signal	NC	NC NO	At start of operation
1-7	Search High Speed	0 pps (disabled)	1 pps : 100,000 pps	At start of operation
1-8	Search Proximity Speed	0 pps (disabled)	1 pps : 100,000 pps	At start of operation
1-9	Origin Compensation Value	0 pps	-2,147,483,648 : 0 : +2,147,483,647	At start of operation
1-10	Origin Search Acceleration Ratio (Rate)	0 (disabled)	1 (pulse/4 ms) : 65,535 (pulse/4 ms)	At start of operation

Name		Default	Possible settings	When setting is read by CPU Unit
1	1-11	0 (disabled)	1 (pulse/4 ms)	At start of operation
			:	
			65,535 (pulse/4 ms)	
1-12	Positioning Monitor Time	0 (ms)	0 (ms)	At start of operation
			:	
			9,999 (ms)	

### Origin Return Settings

Name		Default	Possible settings	When setting is read by CPU Unit
1	Speed	0 pps (disabled)	1 pps	At start of operation
			:	
			100,000 pps	
2	Acceleration Ratio (rate)	0 (disabled)	1 (pulse/4 ms)	At start of operation
			:	
			65,535 (pulse/4 ms)	
3	Deceleration rate	0 (disabled)	1 (pulse/4 ms)	At start of operation
			:	
			65,535 (pulse/4 ms)	

### 7-2-8 Pulse Output 1 Settings

The settings are applicable to the N/NA□□(S)-type CPU Units with transistor outputs.

### Base Settings

Name		Default	Possible settings	When setting is read by CPU Unit
1	Undefined Origin (operation for limit signal turning ON)	Hold	Hold	At start of operation
			Undefined	
2	Limit Input Signal Operation	Search Only	Search Only	When power is turned ON
			Always	
3	Limit Input Signal	NC	NC	At start of operation
			NO	
4	Search/Return Initial Speed	0 pps	0 pps	At start of operation
			:	
			100,000 pps	

## Origin Search Settings

	Name	Default	Possible settings	When setting is read by CPU Unit	
1	Use define origin operation	Do not use.	Do not use. Use.	When power is turned ON	
	1-1	Search Direction	CW CCW	At start of operation	
	1-2	Detection Method	Method 0 Method 1 Method 2	At start of operation	
	1-3	Search Operation	Inverse 1 Inverse 2	At start of operation	
	1-4	Operation Mode	Mode 0 Mode 1 Mode 2	At start of operation	
	1-5	Origin Input Signal	NC NO	When power is turned ON	
	1-6	Proximity Input Signal	NC NO	At start of operation	
	1-7	Search High Speed	0 pps (disabled)	1 pps : 100,000 pps	At start of operation
	1-8	Search Proximity Speed	0 pps (disabled)	1 pps : 100,000 pps	At start of operation
	1-9	Origin Compensation Value	0 pps	-2,147,483,648 : 0 : +2,147,483,647	At start of operation
	1-10	Origin Search Acceleration Ratio (Rate)	0 (disabled)	1 (pulse/4 ms) : 65,535 (pulse/4 ms)	At start of operation
	1-11	Origin Search Deceleration Ratio (Rate)	0 (disabled)	1 (pulse/4 ms) : 65,535 (pulse/4 ms)	At start of operation
1-12	Positioning Monitor Time	0 (ms)	0 (ms) : 9,999 (ms)	At start of operation	

## Origin Return Settings

	Name	Default	Possible settings	When setting is read by CPU Unit
1	Speed	0 pps (disabled)	1 pps	At start of operation
			:	
			100,000 pps	
2	Acceleration Ratio (rate)	0 (disabled)	1 (pulse/4 ms)	At start of operation
			:	
			65,535 (pulse/4 ms)	
3	Deceleration rate	0 (disabled)	1 (pulse/4 ms)	At start of operation
			:	
			65,535 (pulse/4 ms)	

### 7-2-9 Built-in AD/DA: Built-in Analog I/O Settings

The settings are applicable to the NA-type CPU Units with built-in analog I/O.

#### AD 0CH/AD 1CH: Analog Input Settings

	Name	Default	Possible settings	When setting is read by CPU Unit
1	Analog Input 0: Use	Do not use.	Do not use.	When power is turned ON
			Use.	
1-1	Range	-10 to 10 V	-10 to 10 V	When power is turned ON
			0 to 10 V	
			1 to 5 V	
			0 to 5 V	
			0 to 20 mA	
			4 to 20 mA	
1-2	Use averaging	Do not use.	Do not use.	When power is turned ON
			Use.	
2	Analog Input 1: Use	Do not use.	Do not use.	When power is turned ON
			Use.	
2-1	Range	-10 to 10 V	-10 to 10 V	When power is turned ON
			0 to 10 V	
			1 to 5 V	
			0 to 5 V	
			0 to 20 mA	
			4 to 20 mA	
2-2	Use averaging	Do not use	Do not use.	When power is turned ON
			Use.	

#### DA 0CH: Analog Output Settings

	Name	Default	Possible settings	When setting is read by CPU Unit
1	Analog Output 0: Use	Do not use.	Do not use.	When power is turned ON
			Use.	
1-1	Range	-10 to 10 V	-10 to 10 V	When power is turned ON
			0 to 10 V	
			1 to 5 V	
			0 to 5 V	
			0 to 20 mA	
			4 to 20 mA	



# Overview of Built-in Functions and Allocations

---

This section describes the built-in functions, overall procedure, and allocations for functions of the CP1E.

---

<b>8-1</b>	<b>Built-in Functions</b> . . . . .	<b>8-2</b>
<b>8-2</b>	<b>Overall Procedure for Using CP1E Built-in Functions</b> . . . . .	<b>8-3</b>
<b>8-3</b>	<b>Terminal Allocations for Built-in Functions</b> . . . . .	<b>8-4</b>
8-3-1	Specifying the Functions to Use . . . . .	8-4
8-3-2	Selecting Functions in the PLC Setup . . . . .	8-4
8-3-3	Allocating Built-in Input Terminals . . . . .	8-6
8-3-4	Allocating Built-in Output Terminals . . . . .	8-8

# 8-1 Built-in Functions

The following built-in functions are provided by the CP1E E□□(S)-type and N/NA□□(S)-type CPU Units.

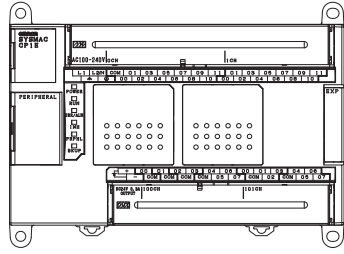
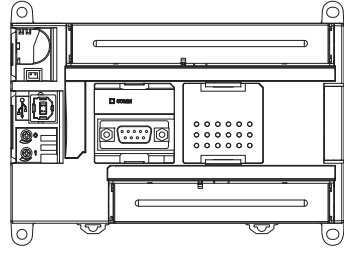
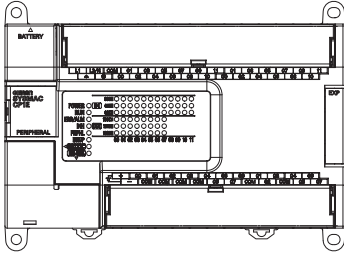
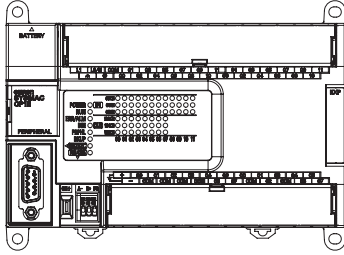
Function		Type	CP1E Basic Models	CP1E Application Models		Reference
		E□□(S)-type CPU Units	N□□(S)-type CPU Units	NA□□-type CPU Units		
Appearance	E/N/NA□□					
	E/N□□S					
Quick-response inputs		E10 CPU Units: 4 inputs E14/20/30/40(S) CPU Units: 6 inputs	6 inputs			Section 9
Input interrupts		E10 CPU Units: 4 inputs E14/20/30/40(S) CPU Units: 6 inputs	6 inputs			Section 10
Scheduled interrupts		1 interrupt	1 interrupt			
High-speed counter		<ul style="list-style-type: none"> <li>Incremental: E10 CPU Units: 10 kHz×5 counters E14/20/30/40 CPU Units: 10 kHz×6 counters</li> <li>Up/down: 10 kHz×2 counters</li> <li>Pulse plus direction: 10 kHz×2 counters</li> <li>Differential phases (4x): 5 kHz×2 counters</li> </ul>	<ul style="list-style-type: none"> <li>Incremental: 100 kHz×2 counters, 10 kHz×4 counters</li> <li>Up/down: 100 kHz×1 counter, 10 kHz×1 counter</li> <li>Pulse plus direction: 100 kHz×2 counters</li> <li>Differential phases (4x): 50 kHz×1 counter, 5 kHz×1 counter</li> </ul>			Section 11
Pulse outputs		Not supported	2 outputs (pulse plus direction only) An external power supply is required for pulse outputs for N30/40/60S(1) CPU Units			Section 12
PWM outputs		Not supported	1 output An external power supply is required for PWM outputs for N30/40/60S(1) CPU Units			Section 13
Serial communications		Not supported	N14/20 CPU Units: 1 port N30/40/60 or NA20 CPU Units: One standard port (RS-232C) plus option slot N30/40/60S CPU Units: One standard port (RS-232C) N30/40/60S1 CPU Units: Two standard ports (RS-232C+RS-485)			Section 14
Analog I/O function		Not supported	Not supported	Supported		Section 15
PID temperature control		Supported	Supported			Section 16-1
Clock functions		Not supported	Supported (While power is supplied.)			Section 16-2
DM backup		Supported	Supported			Section 16-3
Security function		Supported	Supported			Section 16-4

## 8-2 Overall Procedure for Using CP1E Built-in Functions

The overall procedure for using built-in CP1E functions is described in this section.

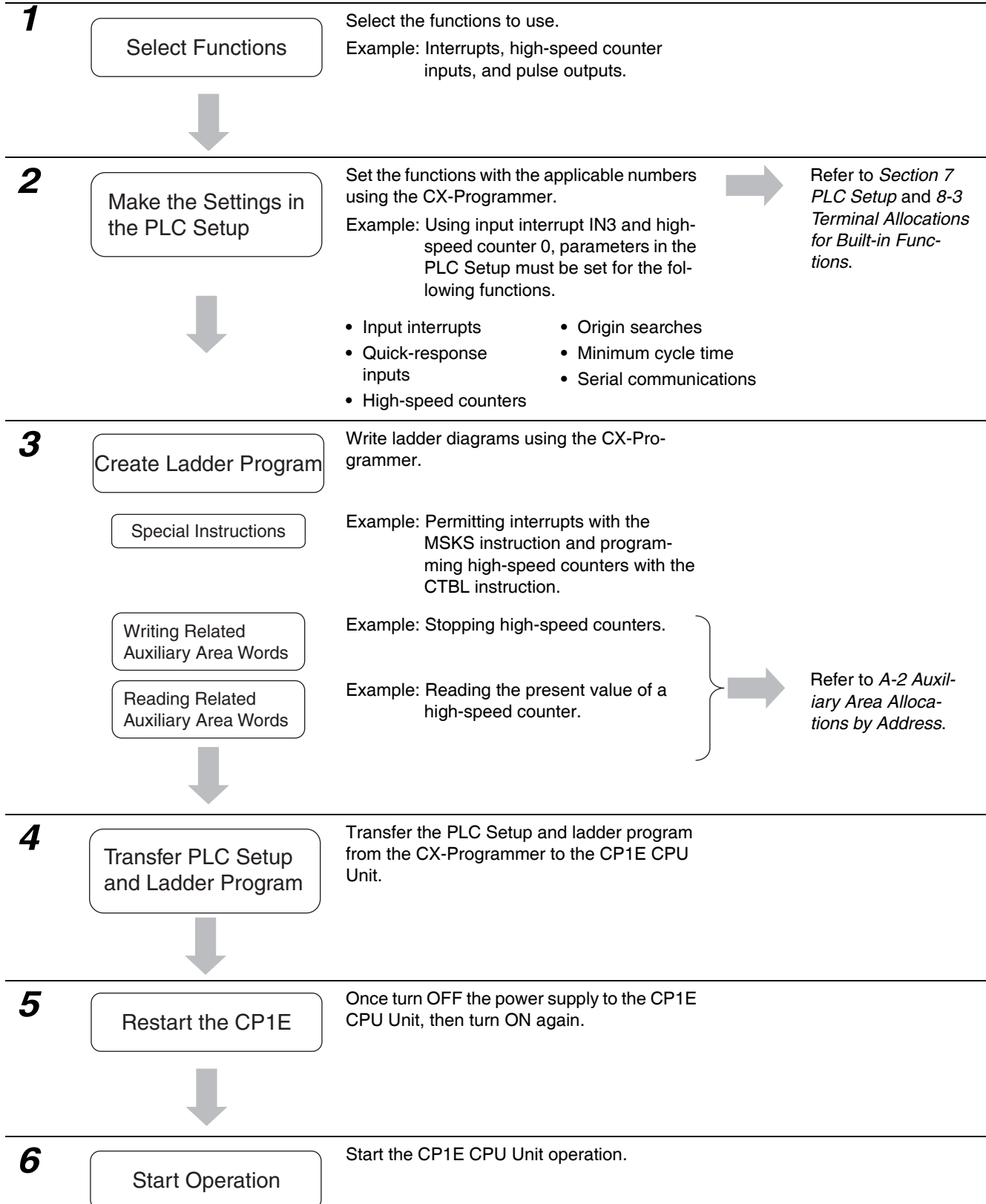

## 8-3 Terminal Allocations for Built-in Functions

### 8-3-1 Specifying the Functions to Use

A CP1E CPU Unit uses the same built-in I/O terminals for different functions. Allocate the I/O terminals in advance, making sure that each terminal is used for only one function.

Specify the input functions in the PLC Setup from the CX-Programmer, and specify the output functions in PLC Setup and programming instructions.

### 8-3-2 Selecting Functions in the PLC Setup

Functions are enabled by setting parameters in the PLC Setup. Set the functions so that no more than one function uses the same terminal. Select function numbers so that high-speed counter inputs and inputs for other functions, such as interrupt inputs, quick-response inputs, and origin inputs do no conflict with each other.

- Input functions can be selected by selecting the **Use high speed counter** Check Box in a **High-speed Counter Area** on the Built-in Input Tab Page or by setting an input to **Interrupt** or **Quick** in the **Interrupt Input Area** of the same page.

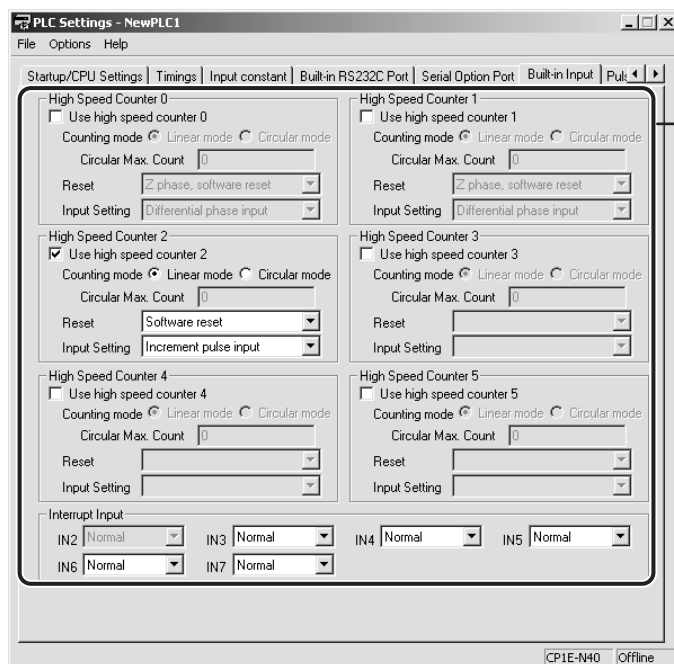



- The input and output terminals used by the origin search function can be enabled by selecting the **Use define origin operation** Check Box on a Pulse Output Tab Page.

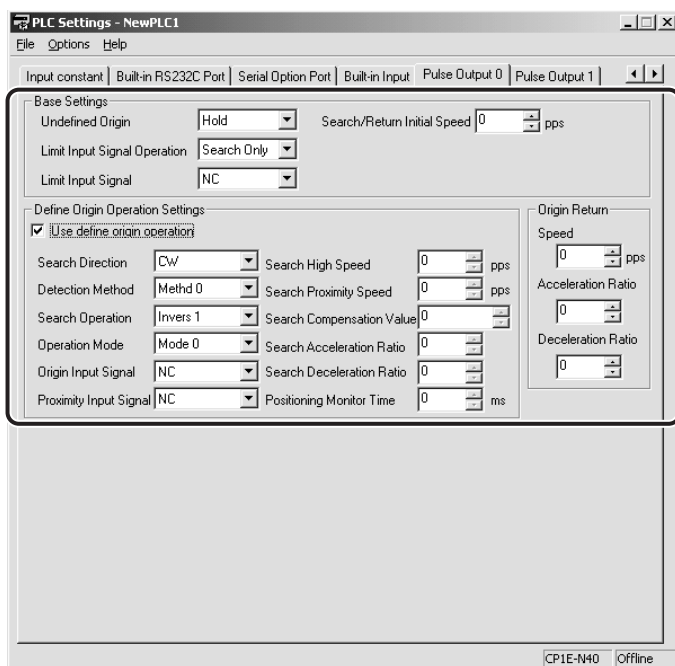

Select the *Use define origin operation* Check Box.

### 8-3-3 Allocating Built-in Input Terminals

#### Allocating Functions to Built-in Input Terminals

Input terminals are allocated functions by setting parameters in the PLC Setup. Set the PLC Setup so that each terminal is used for only one function.

#### ● E20/30/40/60(S), N20/30/40/60(S□) or NA20 CPU Units

Terminal block label	Terminal number	PLC Setup						Origin search settings on Pulse Output 0/1 Tab Page
		Interrupt input settings on Built-in Input Tab Page			High-speed counter 0 to 3 settings on Built-in Input Tab Page			
		Normal	Interrupt	Quick	Use			Use
		Normal input	Interrupt inputs	Quick-response inputs	Increment pulse input	Differential phase ×4 or up/down	Pulse/direction	Origin search
CIO 0	00	Normal input 0	–	–	Counter 0, increment input	Counter 0, phase A or up input	Counter 0, pulse input	–
	01	Normal input 1	–	–	Counter 1, increment input	Counter 0, phase B or down input	Counter 1, pulse input	–
	02	Normal input 2	Interrupt input 2	Quick-response input 2	Counter 2, increment input	Counter 1, phase A or up input	Counter 0, direction	–
	03	Normal input 3	Interrupt input 3	Quick-response input 3	–	Counter 1, phase B or down input	Counter 1, direction	–
	04	Normal input 4	Interrupt input 4	Quick-response input 4	Counter 3, increment input	Counter 0, phase Z or reset input	Counter 0, reset input	–
	05	Normal input 5	Interrupt input 5	Quick-response input 5	Counter 4, increment input	Counter 1, phase Z or reset input	Counter 1, reset input	–
	06	Normal input 6	Interrupt input 6	Quick-response input 6	Counter 5, increment input	–	–	Pulse 0: Origin input signal
	07	Normal input 7	Interrupt input 7	Quick-response input 7	–	–	–	Pulse 1: Origin input signal
	08	Normal input 8	–	–	–	–	–	–
	09	Normal input 9	–	–	–	–	–	–
	10	Normal input 10	–	–	–	–	–	Pulse 0, Origin proximity input signal
11	Normal input 11	–	–	–	–	–	Pulse 1, Origin proximity input signal	
CIO 1	00 to 05	Normal input 12 to 17	–	–	–	–	–	–
	06 to 11	Normal input 18 to 23	–	–	–	–	–	–
CIO 2	00 to 11	Normal input 24 to 35	–	–	–	–	–	–

● E14(S) or N14 CPU Units

Terminal block label	Terminal number	PLC Setup						
		Interrupt input settings on Built-in Input Tab Page			High-speed counter 0 to 3 settings on Built-in Input Tab Page			Origin search settings on Pulse Output 0/1 Tab Page
		Normal	Interrupt	Quick	Use			Use
		Normal input	Interrupt inputs	Quick-response inputs	Increment pulse input	Differential phase x4 or up/down	Pulse/direction	Origin search
CIO 0	00	Normal input 0	–	–	Counter 0, increment input	Counter 0, phase A or up input	Counter 0, pulse input	–
	01	Normal input 1	–	–	Counter 1, increment input	Counter 0, phase B or down input	Counter 1, pulse input	–
	02	Normal input 2	Interrupt input 2	Quick-response input 2	Counter 2, increment input	Counter 1, phase A or up input	Counter 0, direction	–
	03	Normal input 3	Interrupt input 3	Quick-response input 3	–	Counter 1, phase B or down input	Counter 1, direction	Pulse 0, Origin proximity input signal
	04	Normal input 4	Interrupt input 4	Quick-response input 4	Counter 3, increment input	Counter 0, Phase Z or reset input	Counter 0, reset input	–
	05	Normal input 5	Interrupt input 5	Quick-response input 5	Counter 4, increment input	Counter 1, Phase Z or reset input	Counter 1, reset input	Pulse 1, Origin proximity input signal
	06	Normal input 6	Interrupt input 6	Quick-response input 6	Counter 5, increment input	–	–	Pulse 0: Origin input signal
	07	Normal input 7	Interrupt input 7	Quick-response input 7	–	–	–	Pulse 1: Origin input signal

● E10 CPU Units

Terminal block label	Terminal number	PLC Setup					
		Interrupt input settings on Built-in Input Tab Page			High-speed counter 0 to 3 settings on Built-in Input Tab Page		
		Normal	Interrupt	Quick	Use		
		Normal input	Interrupt inputs	Quick-response inputs	Increment pulse input	Differential phase x4 or up/down	Pulse/direction
CIO 0	00	Normal input 0	–	–	Counter 0, increment input	Counter 0, phase A or up input	Counter 0, pulse input
	01	Normal input 1	–	–	Counter 1, increment input	Counter 0, phase B or down input	Counter 1, pulse input
	02	Normal input 2	Interrupt input 2	Quick-response input 2	Counter 2, increment input	Counter 1, phase A or up input	Counter 0, direction
	03	Normal input 3	Interrupt input 3	Quick-response input 3	–	Counter 1, phase B or down input	Counter 1, direction
	04	Normal input 4	Interrupt input 4	Quick-response input 4	Counter 3, increment input	Counter 0, Phase Z or reset input	Counter 0, reset input
	05	Normal input 5	Interrupt input 5	Quick-response input 5	Counter 4, increment input	Counter 1, Phase Z or reset input	Counter 1, reset input

- Note 1** The same pulse inputs must be used for high-speed counter 0 and high-speed counter 1.
- 2** High-speed counter 2 cannot be used if the input setting of high-speed counter 0 or high-speed counter 1 is set for differential phase inputs (4x), pulse + direction inputs, or up/down pulse inputs.

## Prohibiting Repeated Use of Input Terminal Number

The input terminals 00 to 11 of CIO 0 are used for input interrupts, quick-response inputs, high-speed counters, origin searches and normal inputs. Therefore, do not use the input terminals repeatedly. For example, if quick-response input 2 is used, then input terminal 02 is occupied, so it cannot be used for normal input 2, input interrupt 2, quick-response input 2, counter 2 (increment), counter 1 (phase-A/increment) or counter 0 (direction).

A priority is as follows when used repeatedly.

Origin search settings > High-speed counter settings > Input settings

### 8-3-4 Allocating Built-in Output Terminals

## Allocating Functions to Built-in Output Terminals

Output terminals are allocated functions by setting parameters in the PLC Setup. Set the PLC Setup so that each terminal is used for only one function.

### ● E14/20/30/40/60(S), N14/20/30/40/60(S□) or NA20 CPU Units

Output terminal block		Other than those shown at the right	When a pulse output instruction (SPED, ACC, PLS2, or ORG) is executed	PLC Setup	When the PWM instruction is executed
Terminal block label	Terminal number			Normal outputs	
		Fixed duty ratio pulse output		Variable-duty-factor output	
		Pulse + Direction Mode	Use	PWM output	
CIO 100	00	Normal output 0	Pulse output 0, pulse	–	–
	01	Normal output 1	Pulse output 1, pulse	–	PWM output 0
	02	Normal output 2	Pulse output 0, direction	–	–
	03	Normal output 3	Pulse output 1, direction	–	–
	04	Normal output 4	–	Pulse 0, Error counter reset output	–
	05	Normal output 5	–	Pulse 1, Error counter reset output	–
	06	Normal output 6	–	–	–
	07	Normal output 7	–	–	–
CIO 101	00 to 03	Normal output 8 to 11	–	–	–
	04 to 07	Normal output 12 to 15	–	–	–
CIO 102	00 to 07	Normal output 16 to 23	–	–	–

### ● E10 CPU Units

Output terminal block		Other than those shown at the right
Terminal block label	Terminal number	Normal outputs
CIO 100	00	Normal output 0
	01	Normal output 1
	02	Normal output 2
	03	Normal output 3

## Prohibiting Repeated Use of Output Terminal Number

The output terminals 00 to 07 of CIO 100 are used for pulse outputs, PWM outputs and normal outputs. Therefore, do not use the output terminals repeatedly. For example, if pulse output 0 (direction) is used, then output terminal 02 is occupied, so it cannot be used for normal output 2.



# Quick-response Inputs

This section describes the quick-response inputs that can be used to read signals that are shorter than the cycle time.

---

<b>9-1 Quick-response Inputs</b> .....	<b>9-2</b>
9-1-1 Overview .....	9-2
9-1-2 Flow of Operation .....	9-3

# 9-1 Quick-response Inputs

Quick-response inputs can be used with any model of CP1E CPU Unit.

## 9-1-1 Overview

The quick-response inputs can read pulses with an ON time as short as 50  $\mu\text{s}$  even if they are shorter than the cycle time. Use the quick-response inputs to read signals shorter than the cycle time, such as inputs from photomicrosensors.

Pulse signal from photomicrosensor or other device

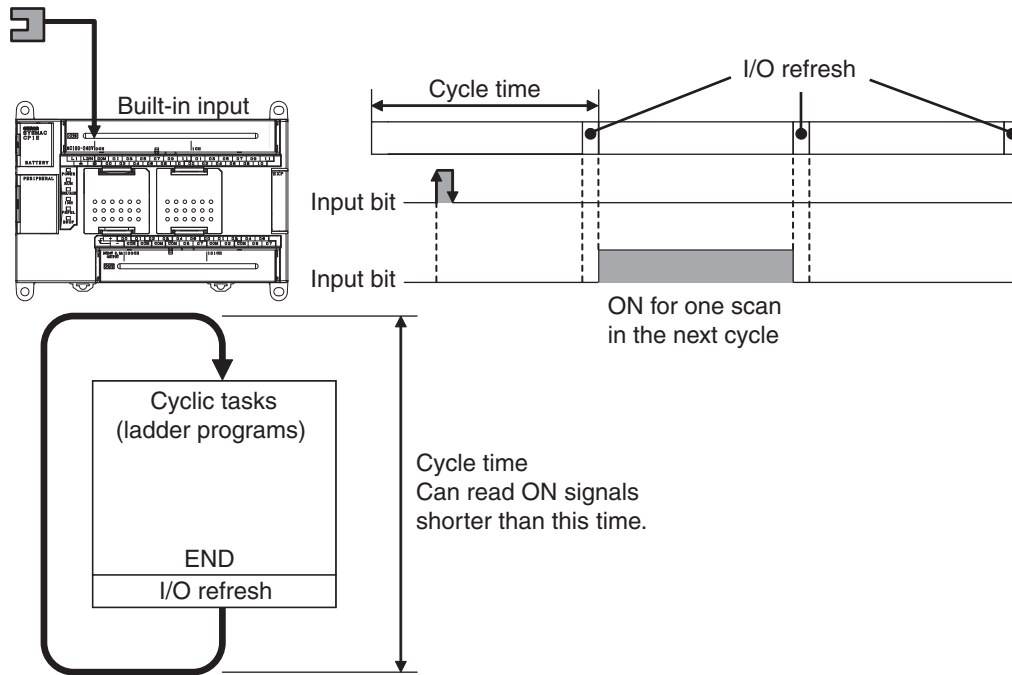

The pulse widths of quick-response input signals must meet the following conditions.

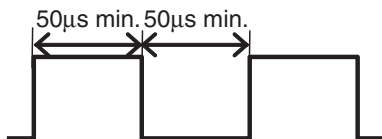

### 9-1-2 Flow of Operation

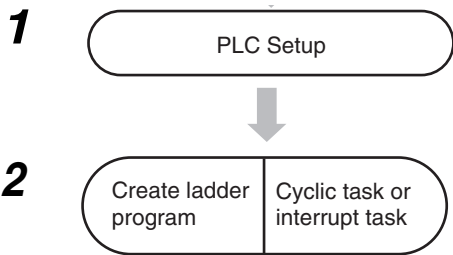

- Set IN2 to IN7 for quick-response inputs on the Built-in Input Tab Page of the PLC Setup using the CX-Programmer.
  - The terminals 02 to 07 of CIO 0 can be used for quick-response inputs. Bits CIO 0.02 to CIO 0.07 correspond to terminals 02 to 07.
- Read the status of CIO 0.02 to CIO 0.07 using the LD instruction or other instructions.

#### Precautions for Correct Use

A built-in input cannot be used as a quick-response input if it is being used as a normal input, interrupt input, or high-speed counter input. Refer to 8-3-3 *Allocating Built-in Input Terminals* for details.

## PLC Setup

Click the Built-in Input Tab and select **Quick** in the interrupt input settings.

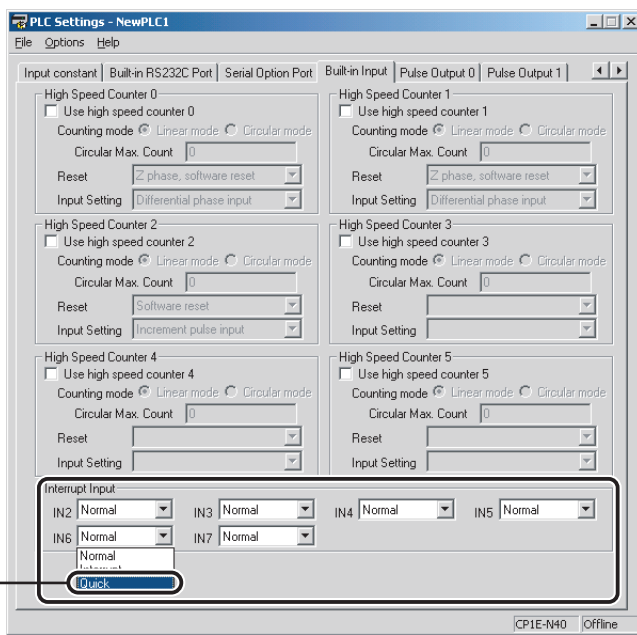

Built-in Input Tab Page

Quick-response input setting	Corresponding bit address
IN2	Select <b>Quick</b> for IN2 to IN7.
IN3	
IN4	
IN5	
IN6	
IN7	

- Note 1** The power supply must be restarted after the PLC Setup is transferred in order to validate the quick-response input settings.
- 2** IN6 and IN7 are not supported by E10 CPU Units.

## Quick-response Input Terminal

The following terminals can be used for quick-response inputs.

### ● Input Terminal Block on CPU Unit with 20 I/O Points

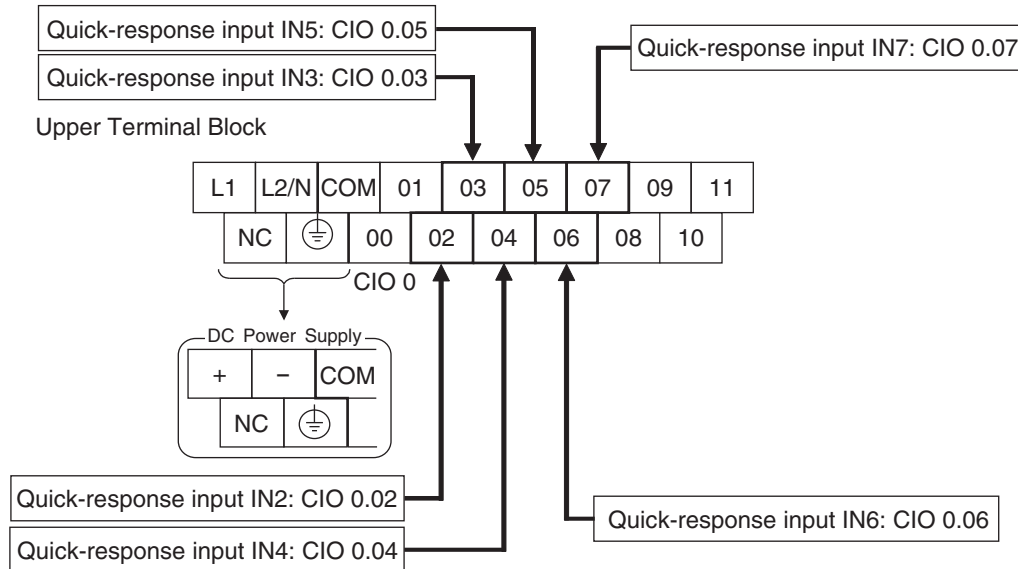

## Creating Ladder Programs

Pulse inputs shorter than the cycle time can be read in the CPU Unit I/O memory using normal instructions. Simply set the interrupt setting for the required input to *Quick* in the PLC Setup.

The status of CIO 0.02 to CIO 0.07 can be read using instructions such as the LD instruction.

Example: Setting IN2 to *Quick* in the PLC Setup Interrupt Settings.

Even if the signal that is input to terminal 02 on terminal block 0CH is shorter than the cycle time, the signal will be latched in one cycle and the status will be stored in CIO 0.02.



- The minimum pulse width (ON time) that can be read for a quick-response input is 50  $\mu$ s.
- The status of the input that is stored in the I/O memory for a short input will be cleared during the next I/O refresh period.



# 10

## Interrupts

This section describes the interrupts that can be used with CP1E PLCs, including input interrupts and scheduled interrupts.

---

<b>10-1 Interrupts</b> .....	<b>10-2</b>
10-1-1 Overview .....	10-2
<b>10-2 Input Interrupts</b> .....	<b>10-3</b>
10-2-1 Overview .....	10-3
10-2-2 Flow of Operation .....	10-4
10-2-3 Application Example .....	10-7
<b>10-3 Scheduled Interrupts</b> .....	<b>10-10</b>
10-3-1 Overview .....	10-10
10-3-2 Flow of Operation .....	10-11
<b>10-4 Precautions for Using Interrupts</b> .....	<b>10-13</b>
10-4-1 Interrupt Task Priority and Order of Execution .....	10-13
10-4-2 Related Auxiliary Area Words and Bits .....	10-13
10-4-3 Duplicate Processing in each Task .....	10-13

# 10-1 Interrupts

## 10-1-1 Overview

CP1E CPU Units normally repeat processes in the following order: overseeing processes, program execution, I/O refreshing, peripheral servicing. During the program execution stage, cyclic tasks (ladder programs) are executed.

The interrupt function, on the other hand, allows a specified condition to interrupt a cycle and execute a specified program.

Interrupts can thus be used to perform high-speed processing that is not restricted by the cycle time.

The CP1E performs the following processing when an interrupt occurs.

(1)When an interrupt occurs, execution of the ladder programs in cyclic tasks is interrupted.

(2)The ladder program in the interrupt task is executed.

(3)When the interrupt task is finished, the ladder program that was being executed is returned to.

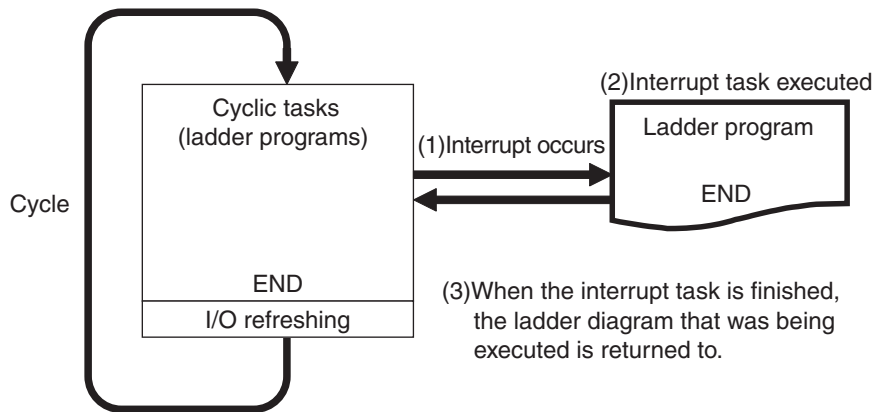

## Interrupt Factors and Types of Interrupts

Interrupts are classified by the interrupt factor. There are the following three types of interrupts.

- Changes in status of built-in inputs on the CPU Unit → *Input Interrupts* in Page 10-3
- Specified intervals measured by internal timers → *Scheduled Interrupts* in Page 10-10
- PVs of high-speed counter → *High-speed Counter Interrupts* in Page 11-14

# 10-2 Input Interrupts

Input interrupts can be used with any model of CP1E CPU Unit.

## 10-2-1 Overview

A corresponding interrupt task can be executed when a built-in input on the CPU Unit turns ON or turns OFF.

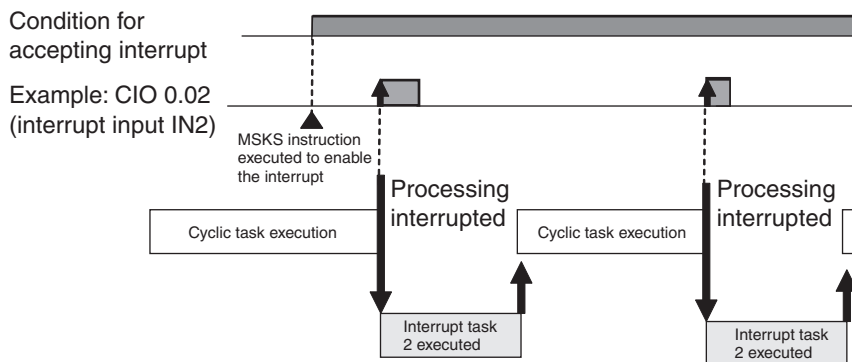
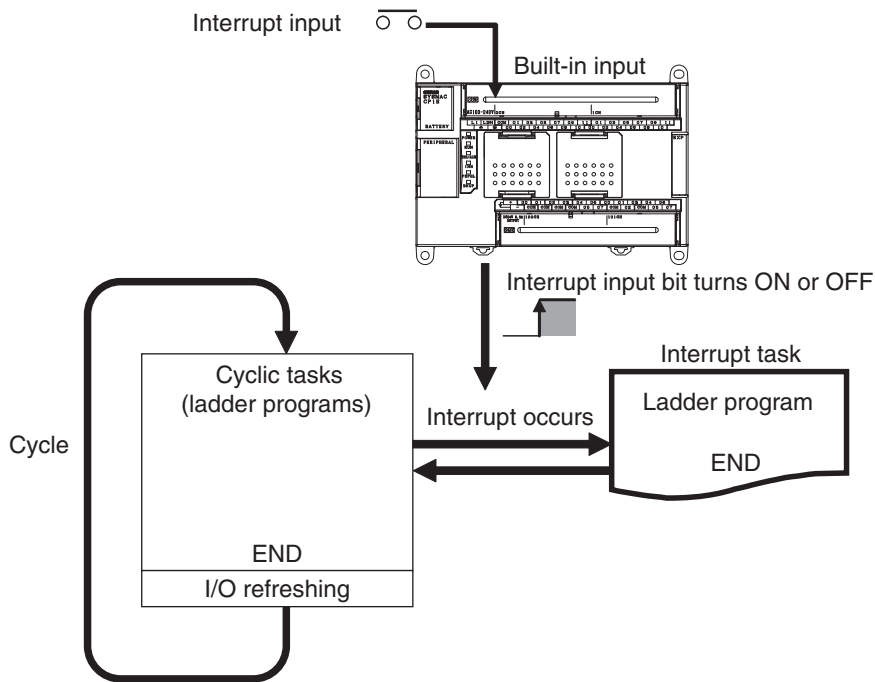

The pulse widths of interrupt input signals must meet the following conditions.

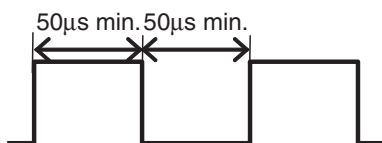

## 10-2-2 Flow of Operation

1

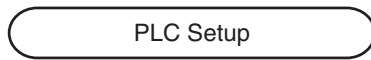

- Set IN2 to IN7 for interrupt inputs on the Built-in Input Tab Page of the PLC Setup using the CX-Programmer.
- Terminals 02 to 07 on the CIO 0 terminal block can be used for interrupt inputs. Bits CIO 0.02 to CIO 0.07 correspond to terminals 02 to 07.



2

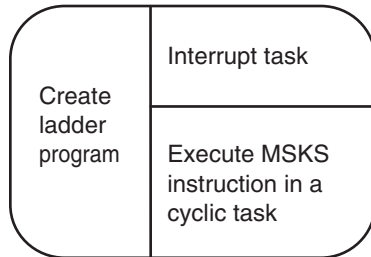

Write the program in the interrupt task. Interrupt tasks 2 to 7 correspond to interrupt inputs 2 to 7.

- Specify whether the interrupt is executed when the input turns ON or when it turns OFF in the MSKS instruction. Set N to 112 to 117 in the MSKS instruction.
- Enable input interrupts in the MSKS instruction. Set N to 102 to 107 in the MSKS instruction.



### Precautions for Correct Use

A built-in input cannot be used as a normal input, high-speed counter input, or quick-response input if it is being used as an interrupt input. Refer to 8-3-3 *Allocating Built-in Input Terminals* for details.

## PLC Setup

Click the Built-in Input Tab and select **Interrupt** in the interrupt input settings.

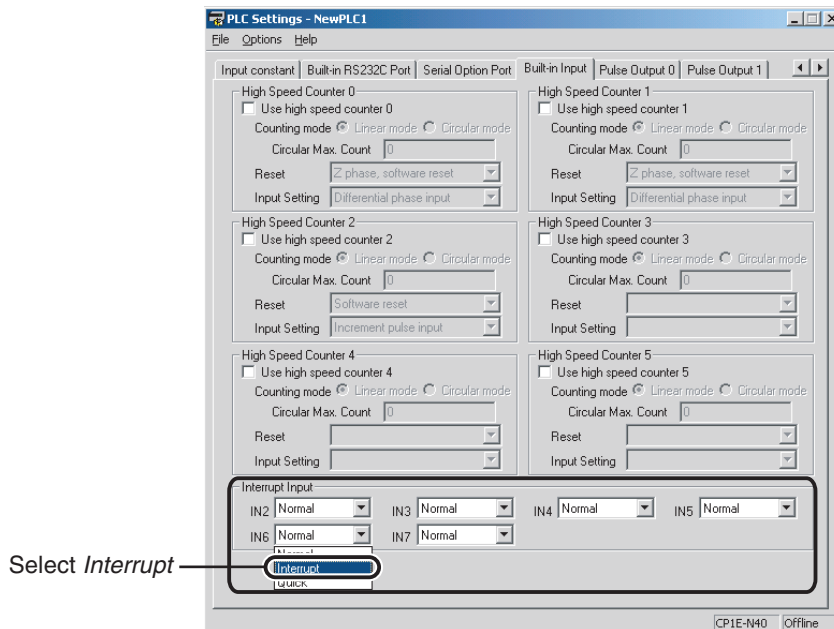

## Built-in Input Tab Page

Interrupt input settings		Corresponding bit address	Scheduled interrupt task
IN2	Select <i>Interrupt</i> for IN2 to IN7.	CIO 0.02	2
IN3		CIO 0.03	3
IN4		CIO 0.04	4
IN5		CIO 0.05	5
IN6		CIO 0.06	6
IN7		CIO 0.07	7

**Note 1** The power supply must be restarted after the PLC Setup is transferred in order to enable the interrupt input settings.

**2** IN6 and IN7 are not supported by E10 CPU Units.

## Assigning Interrupt Input Terminals

The following input terminals can be used for interrupt inputs. These terminals correspond to CIO 0.02 to CIO 0.07 in I/O memory.

### ● Input Terminal Block on CPU Unit with 20 I/O Points

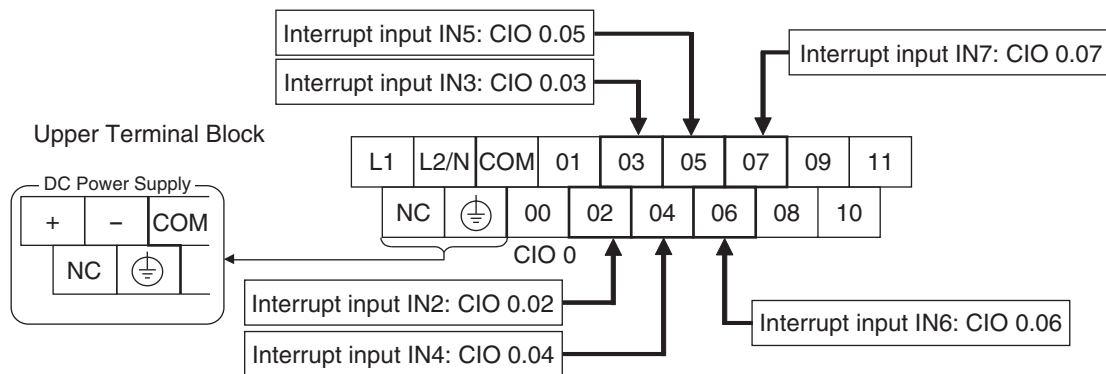

## Writing the Ladder Program

### ● Writing the Interrupt Task's Ladder Program

Create ladder programs for interrupt tasks 2 to 7, which are executed for the corresponding interrupt inputs. Right-click a program in the CX-Programmer and select **Properties**. Select interrupt tasks 2 to 7 in the **Task Type** Field of the Program Properties Dialog Box.

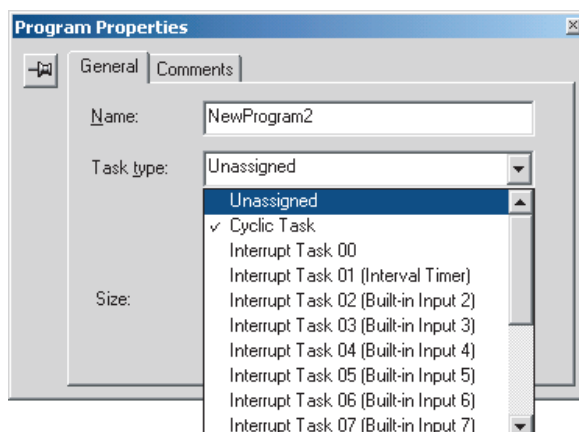

● **Execute MSKS Instruction in a Cyclic Task**

Execute the MSKS instruction from the ladder program in a cyclic task to use input interrupts.

MSKS has the following two functions and two of this instruction are normally used in combination.

(1)Specifying whether to detect ON or OFF signals.

(2)Enabling input interrupts.

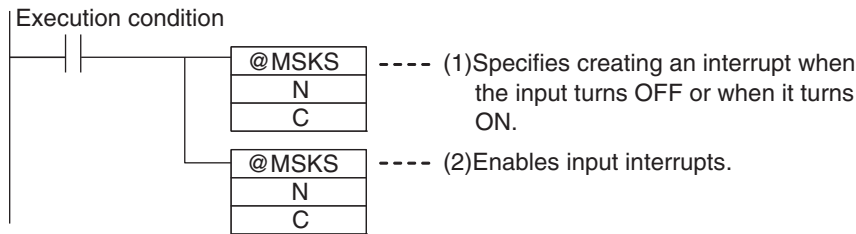

The MSKS instruction must be executed only once to make the settings, so in general execute MSKS in just one cycle using the upwardly differentiated variation of the instruction.

The first MSKS instruction can be omitted. If it is omitted, an interrupt will be created when the input turns ON by default.

● **Specifying MSKS Operands (N and C)**

(1)Specifying to Detect ON or OFF Input Signals

Terminal	Corresponding bit address	PLC Setup on Built-in Input Tab Page	Interrupt task number	Operand N	Operand C
				Interrupt identifier	Specifying up/down differentiation of an interrupt input
02 on CIO 0 terminal block	CIO 0.02	Interrupt input IN2	2	112	#0000: Up-differentiation #0001: Down-differentiation
03 on CIO 0 terminal block	CIO 0.03	Interrupt input IN3	3	113	
04 on CIO 0 terminal block	CIO 0.04	Interrupt input IN4	4	114	
05 on CIO 0 terminal block	CIO 0.05	Interrupt input IN5	5	115	
06 on CIO 0 terminal block	CIO 0.06	Interrupt input IN6*	6	116	
07 on CIO 0 terminal block	CIO 0.07	Interrupt input IN7*	7	117	

\* Interrupt input 6 and 7 are not supported by E10 CPU Units.

(2)Enabling the Input Interrupt

Terminal	Corresponding bit address	PLC Setup on Built-in Input Tab Page	Interrupt task number	Operand N	Operand C
				Interrupt identifier	Enable/Disable
02 on CIO 0 terminal block	CIO 0.02	Interrupt input IN2	2	102	#0000: Enable interrupt #0001: Disable interrupt
03 on CIO 0 terminal block	CIO 0.03	Interrupt input IN3	3	103	
04 on CIO 0 terminal block	CIO 0.04	Interrupt input IN4	4	104	
05 on CIO 0 terminal block	CIO 0.05	Interrupt input IN5	5	105	
06 on CIO 0 terminal block	CIO 0.06	Interrupt input IN6*	6	106	
07 on CIO 0 terminal block	CIO 0.07	Interrupt input IN7*	7	107	

\* Interrupt input 6 and 7 are not supported by E10 CPU Units.

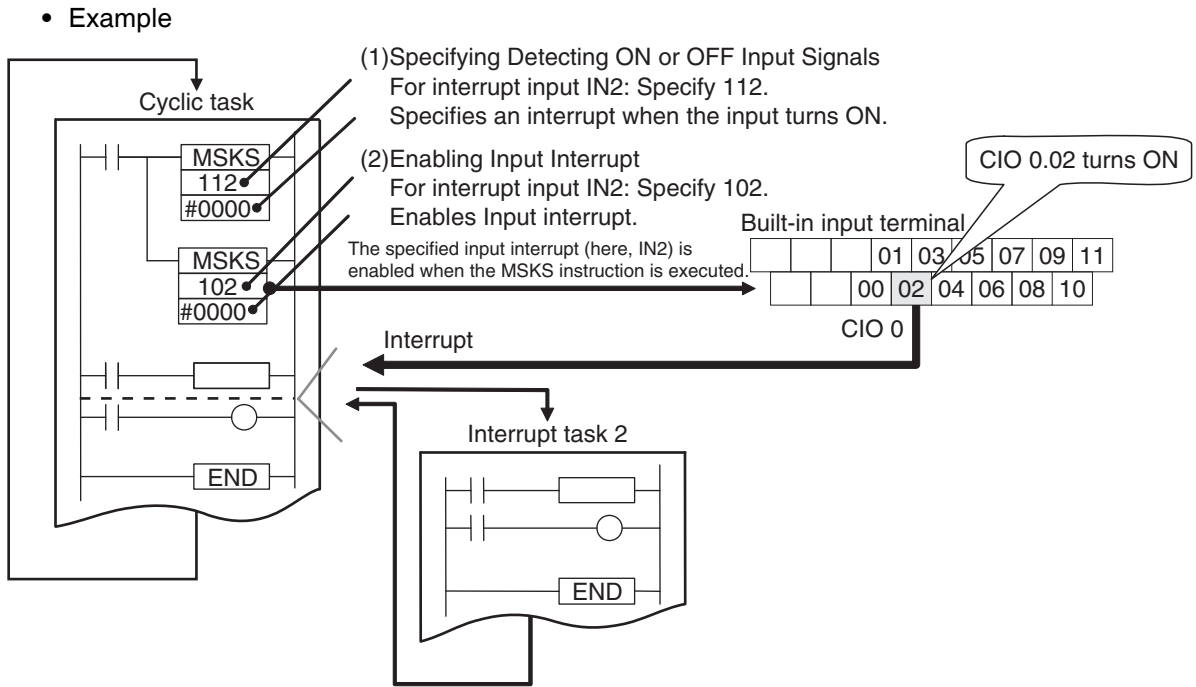

### 10-2-3 Application Example

In this example, bent parts are detected in a moving workpiece, such as an IC component. When the sensor input (terminal 02 on terminal block 0CH = CIO 0.02) changes from OFF to ON, the interrupt task is executed.

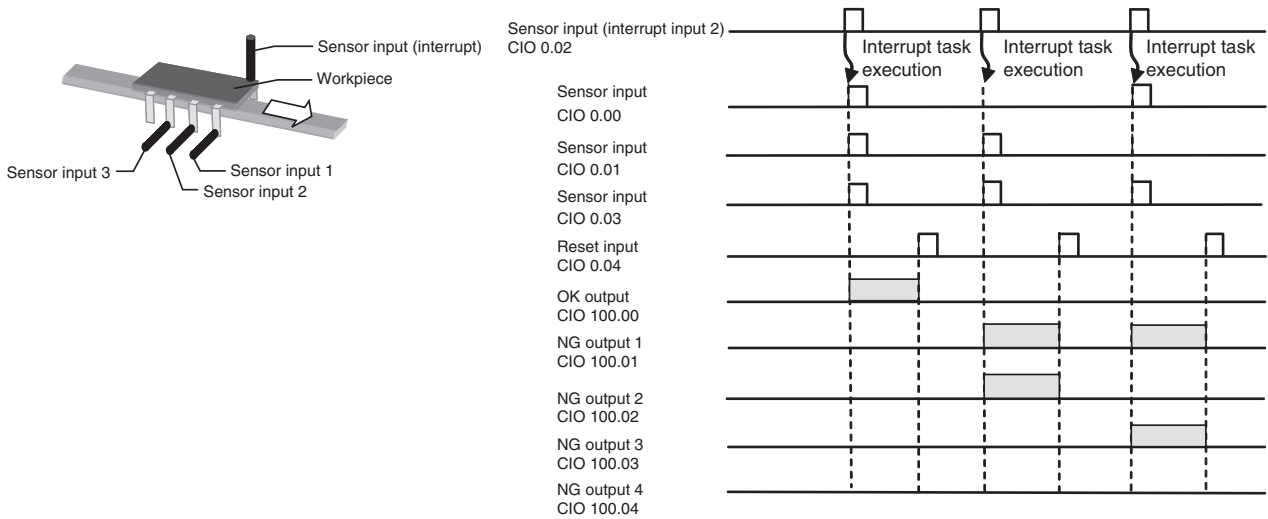

## 1 PLC Setup

Set IN2 to **Interrupt** in the interrupt input settings on the Built-in Input Tab Page.

## 2 Connecting Interrupt Input Terminals

Terminal 2 on terminal block 0CH is interrupt input IN2.

Interrupt task 2 corresponds to interrupt input 2.

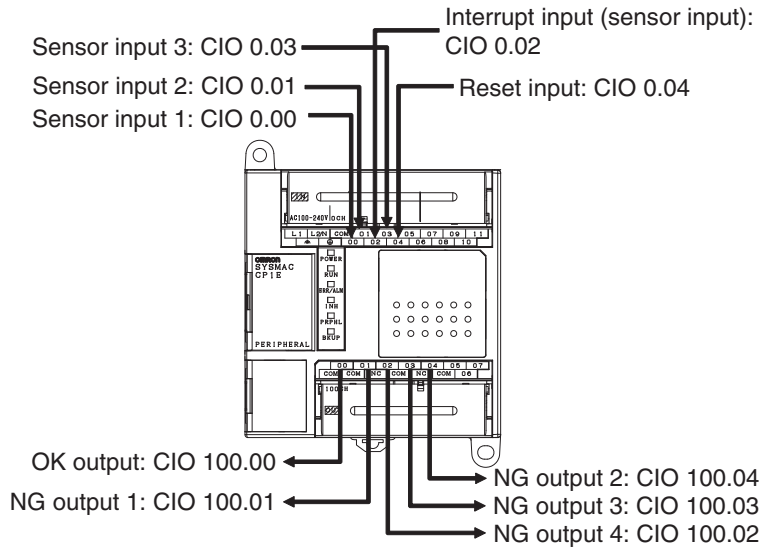



● Programming Example

Cyclic Task

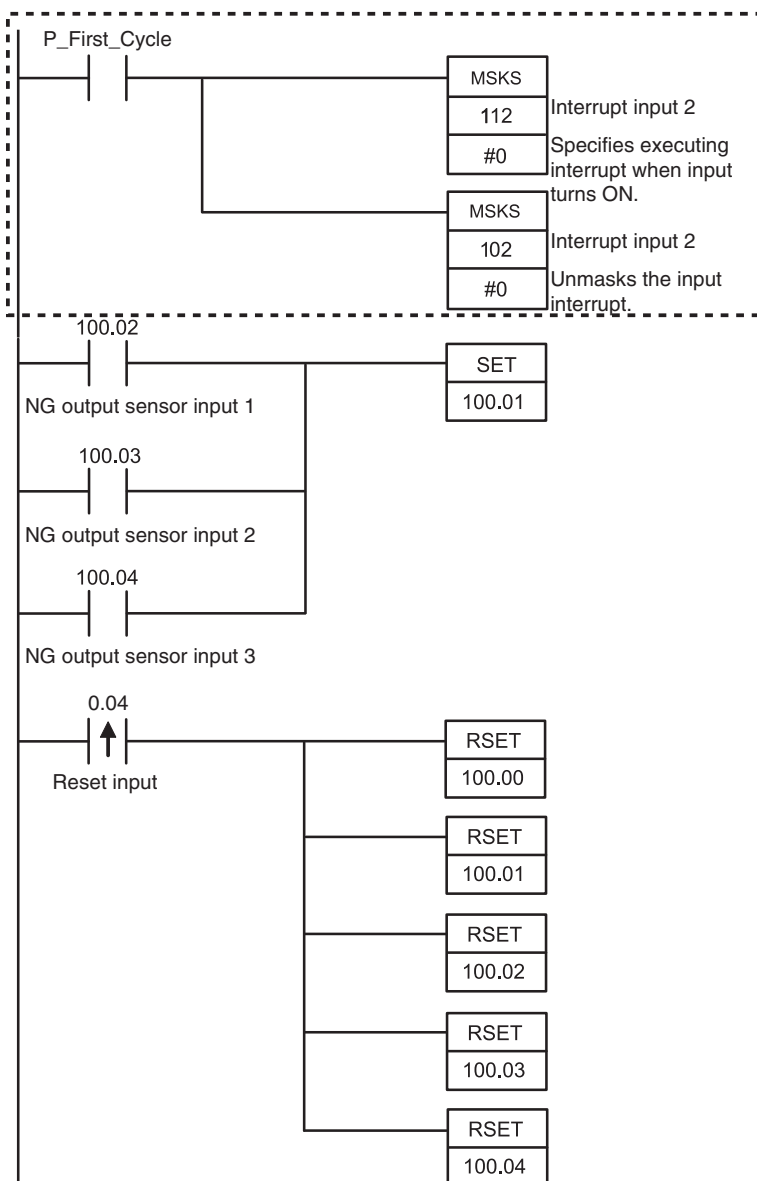

The MSKS instruction is used to specify an interrupt when the input turns ON and then it is used to unmask the input interrupt.

Interrupt Task 2

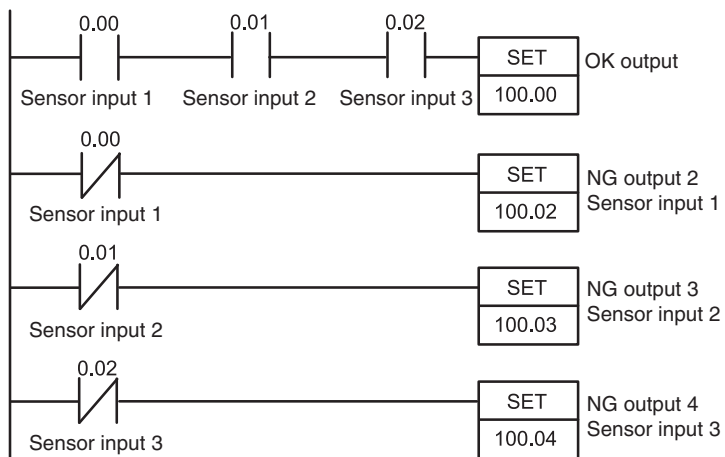

# 10-3 Scheduled Interrupts

Scheduled interrupts can be used with any model of CP1E CPU Unit.

## 10-3-1 Overview

Scheduled interrupts can be used to execute interrupt tasks at fixed time intervals measured by the CPU Unit's internal timer.

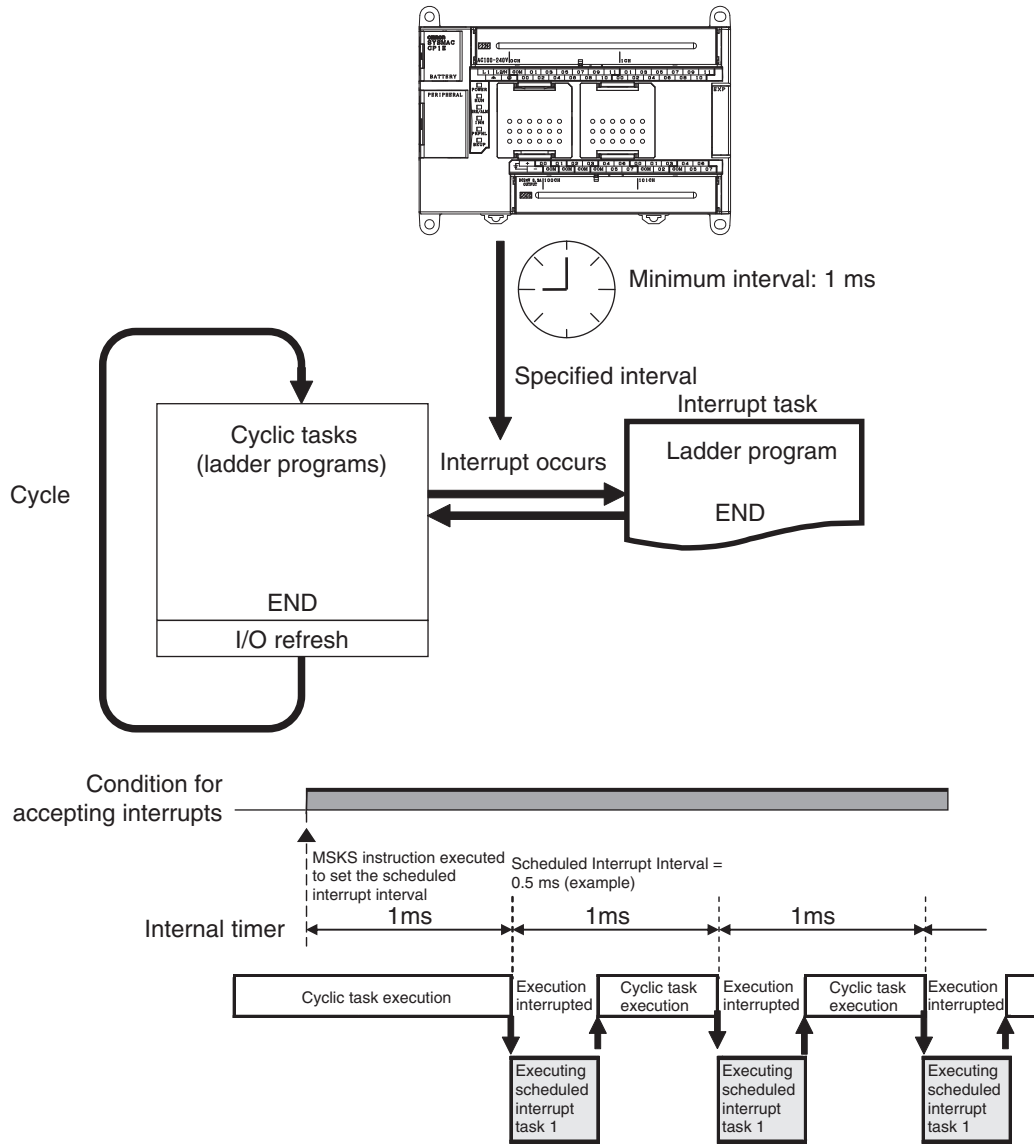

## 10-3-2 Flow of Operation

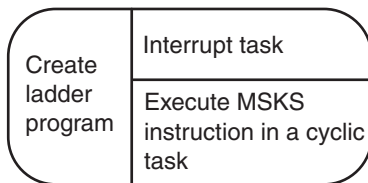

Write the program for the corresponding interrupt task 1 (fixed).

Use MSKS to specify the scheduled interrupt interval. The setting can be 1 ms or longer. Set N to 4 or 14 in the MSKS instruction.

## Writing the Ladder Program

### ● Writing the Interrupt Task Program

Create the program for interrupt task 1, which is executed for the scheduled interrupt. Right-click a program in the CX-Programmer and select **Properties**. Select Interrupt Tasks 01 (scheduled interrupt) in **Task Type** Field of the Program Properties Dialog Box.

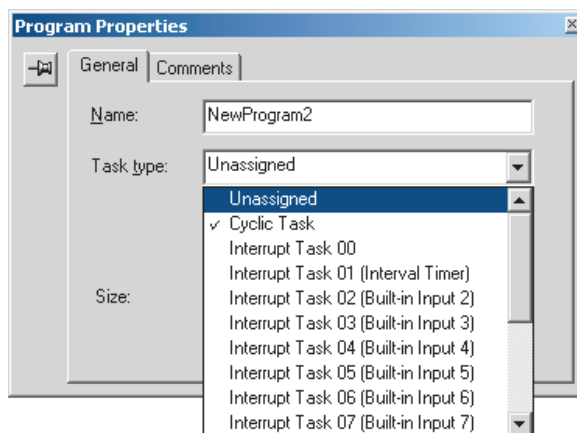

### ● Execute MSKS in a Cyclic Task

The MSKS instruction must be executed from the ladder program in a cyclic task in order to use scheduled interrupts.

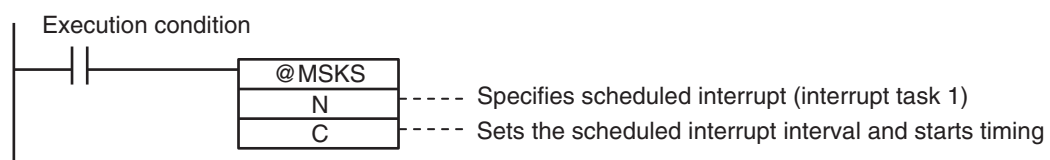

The MSKS instruction must be executed only once to make the settings, so in general execute MSKS in just one cycle using the upwardly differentiated variation of the instruction.

## Specifying MSKS Operands (N and C)

### MSKS Operands

MSKS Operands	
N	C
Interrupt number	Scheduled interrupt interval
Scheduled interrupt (interrupt task 1)* 14: Reset and restart 4: Reset and restart	0 decimal: Disable interrupt (stop internal timer) 10 to 9,999 decimal: Enable interrupt (Reset internal timer and then start timer with interrupt interval between 1.0 and 999.9 ms)

\* Either is reset.

### Example

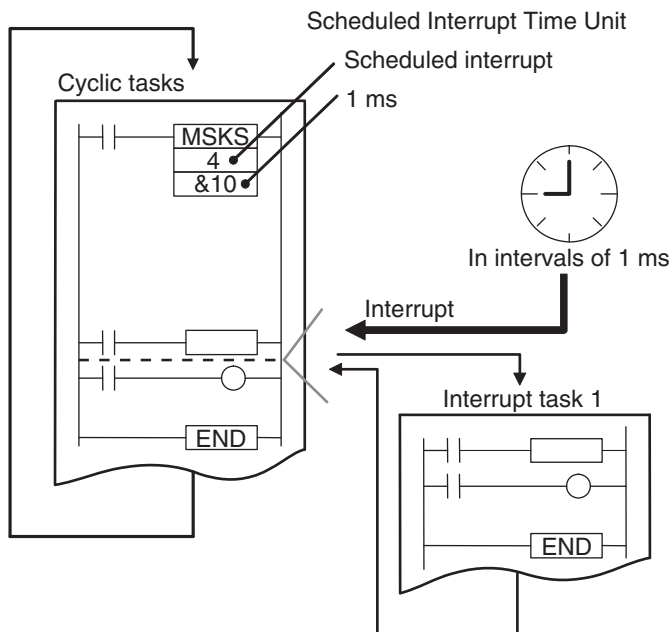

### Precautions for Correct Use

- Set a scheduled interrupt interval is longer than the time required to execute the corresponding interrupt task.
- If you shorten the scheduled interrupt interval and increase the execution frequency of the scheduled interrupt task, the cycle time will increase, and this will affect the execution timing of cyclic tasks.
- If an interrupt task is being executed for another interrupt (input interrupt or high-speed counter interrupt) when the scheduled interrupt occurs, the scheduled interrupt will not be executed until the other interrupt task had been completed.  
Even in this case, measurement of internal timer is continually executed in parallel, so the execution of scheduled interrupt tasks will not be delayed.
- Scheduled interrupt interval cannot be changed during the startup of scheduled interrupt. Change the interval after the scheduled interrupt has stopped.

## 10-4 Precautions for Using Interrupts

### 10-4-1 Interrupt Task Priority and Order of Execution

The priority of interrupt tasks is the same order for input interrupts, scheduled interrupts and high-speed counter interrupts. Therefore, if interrupt task A (an input interrupt, for example) is being executed when interrupt task B (a scheduled interrupt, for example) occurs, task A execution will not be interrupted. Task B execution will be started when task A had been completed.

For example, if an interrupt task is being executed for another interrupt (input interrupt or high-speed counter interrupt) when a scheduled interrupt occurs, the scheduled interrupt will not be executed until execution of the other interrupt task had been completed. Even in this case, internal timer is continually measured in parallel, so the execution of the scheduled interrupt task will not be delayed.

### 10-4-2 Related Auxiliary Area Words and Bits

When the processing time of an interrupt task exceeds 0.1ms, the processing time of the interrupt task and the task number of the interrupt with the maximum processing time can be found in the Auxiliary Area. The actual processing time can also be checked.

Name	Addresses	Description
Maximum Interrupt Task Processing Time	A440	Contains the maximum interrupt task processing time in units of 0.1 ms. This value is cleared at the start of operation.
Interrupt Task With Maximum Processing Time	A441	Contains the task number of the interrupt task with the maximum processing time. Here, #8000 to #800F correspond to tasks 0 to 15 (00 to 0F hex). A441.15 will turn ON when the first interrupt occurs after the start of operation. The maximum processing time for subsequent interrupt tasks will be stored in the rightmost digit in hexadecimal. This value is cleared at the start of operation.
Total of Interrupt Task Processing Time in One Cycle	A442	Contains the total of interrupt task processing time in one cycle in units of 0.1ms. Sets when the value is bigger than the last one once a cycle by common processing. This value is cleared at the start of operation. The value is unstable for CPU Unit version 1.0 or earlier.

### 10-4-3 Duplicate Processing in each Task

Observe the following precautions, if a word address in I/O memory is manipulated by instructions both in a cyclic task and an interrupt task.

- If the interrupt task overwrites an I/O memory address used by one of the interrupted instruction's operands, the data may be overwritten when the saved data is restored when processing returns to the cyclic task.
- To prevent certain instructions from being interrupted during processing, insert the DI or EI instruction just before and after the instructions, using the DI or EI instruction before the instructions to disable interrupts and the DI or EI instruction after the instructions to enable interrupts again.



#### Additional Information

Normally, if an interrupt occurs, execution of the cyclic task will be interrupted immediately, even during execution of an instruction in the cyclic task, and the partially processed data is saved. After the interrupt task had been completed, the cyclic task restarts with the data saved before the interrupt processing.



# High-speed Counters

This section describes the high-speed counter inputs, high-speed counter interrupts, and the frequency measurement function.

---

<b>11-1 Overview</b> .....	<b>11-2</b>
11-1-1 Overview .....	11-2
11-1-2 Flow of Operation .....	11-3
11-1-3 Specifications .....	11-7
<b>11-2 High-speed Counter Inputs</b> .....	<b>11-8</b>
11-2-1 Pulse Input Methods Settings .....	11-8
11-2-2 Counting Ranges Settings .....	11-10
11-2-3 Reset Methods .....	11-11
11-2-4 Reading the Present Value .....	11-12
11-2-5 Frequency Measurement .....	11-13
<b>11-3 High-speed Counter Interrupts</b> .....	<b>11-14</b>
11-3-1 Overview .....	11-14
11-3-2 Present Value Comparison .....	11-17
11-3-3 High-speed Counter Interrupt Instruction .....	11-21
<b>11-4 Related Auxiliary Area Bits and Words</b> .....	<b>11-26</b>
<b>11-5 Application Example</b> .....	<b>11-27</b>

# 11-1 Overview

High-speed counters can be used with any model of CP1E CPU Unit.

## 11-1-1 Overview

High-speed counters are used to measure high-speed pulse input signals that cannot be measured by counter (CNT) instructions.

### ● Applications

- Detecting the position or length of a workpiece with an input from an incremental rotary encoder.
- Measuring the speed of a workpiece from its position data using frequency measurement and rotational speed conversion.
- High-speed processing according to the workpiece's position data.

The present value of the high-speed counter is stored in the Auxiliary Area and can be used as position data. When it reaches preset values, interrupts can be generated. The count can be started and stopped. Depending on the instruction, the frequency (speed) can be read from the present value of the high-speed counter.

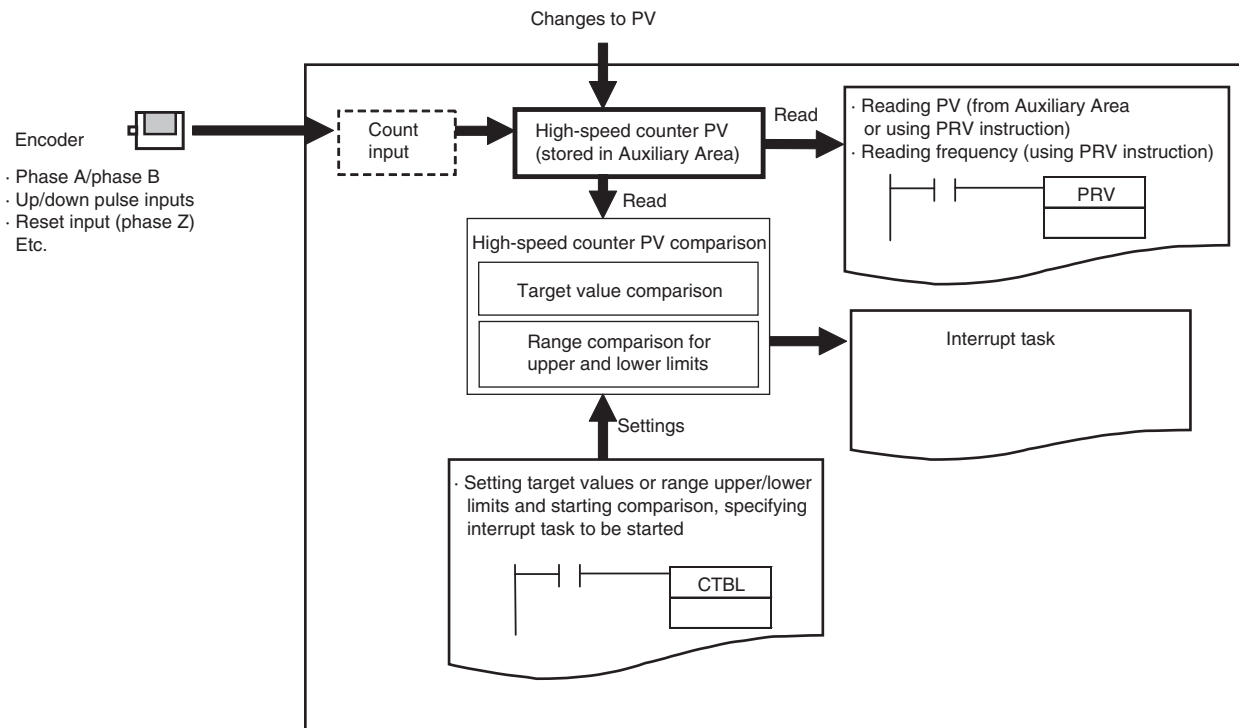



### 11-1-2 Flow of Operation

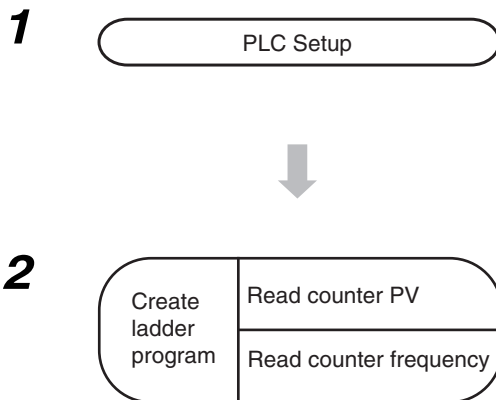

- Enable the required high-speed counters.
- Select the *Use high speed counter* Check Box for high-speed counters 0 to 5. Set the input setting, counting mode and reset method on the Built-in Input Tab Page of the PLC Setup using the CX-Programmer.
- Terminals 00 to 06 on the CIO 0 terminal block can be used for high-speed counters. High-speed counters 0 to 5 correspond to terminals 00 to 06.
- Read the PV from Auxiliary Area or by executing a PRV instruction.
- Execute a PRV instruction.

#### Precautions for Correct Use

A built-in input cannot be used as a normal input, interrupt input, or quick-response input if it is being used as a high-speed counter input. Refer to *8-3-3 Allocating Built-in Input Terminals* for details.

### PLC Setup

Click the Built-in Input Tab and select the *Use high speed counter* Check Box for high-speed counters 0 to 5. Set the counting mode, reset method, and input setting.

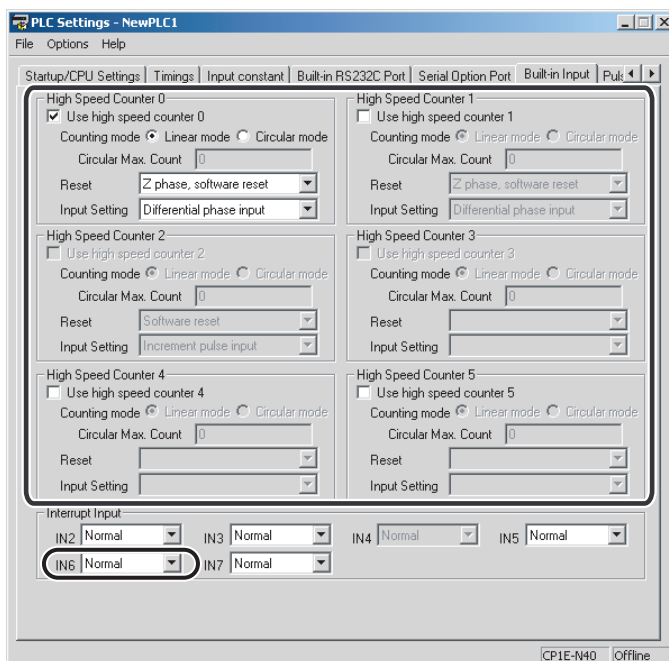

Built-in Input Tab Page

Item		Setting
Use high speed counter 0 to 5	Use high-speed counter	Select <i>Use high speed counter</i> for each counter to be used.
	Counting Mode	Select <i>Linear mode</i> or <i>Circular mode</i> .
	Circular Max. Count (maximum ring count)	If circular mode is selected, set the maximum ring count. 0 to 4,294,967,295 decimal
	Reset	<ul style="list-style-type: none"> <li>Phase Z and software reset</li> <li>Software reset*</li> <li>Phase Z and software reset (continue comparing)</li> <li>Software reset (continue comparing)*</li> </ul>
	Input Setting	<ul style="list-style-type: none"> <li>Differential phase inputs (4x)</li> <li>Pulse + direction inputs</li> <li>Up/down pulse inputs</li> <li>Increment pulse input</li> </ul>

\* Only a software reset can be used if an increment pulse input is specified.

**Note** The power supply must be restarted after the PLC Setup is transferred in order to enable the high-speed counter settings.

## Determining High-speed Counter

### ● Pulse Input Method and High-speed Counter Input Terminals

The following input terminals can be used for high-speed counters with the pulse input method.

#### E20/30/40/60(S), N20/30/40/60(S□) or NA20 CPU Units

Input terminal block		Pulse input method (Counting mode)			Other functions that cannot be used at the same time			
Terminal block label	Terminal	Increment pulse input	Differential phase ×4 or up/down input	Pulse/direction input	Normal input	Interrupt input	Quick-response input	Origin searches for pulse outputs 0 and 1
CIO 0	00	High-speed Counter 0, increment input	High-speed Counter 0, phase A or up input	High-speed Counter 0, pulse input	Normal input 0	–	–	–
	01	High-speed Counter 1, increment input	High-speed Counter 0, phase B or down input	High-speed Counter 1, pulse input	Normal input 1	–	–	–
	02	High-speed Counter 2, increment input	High-speed Counter 1, phase A or up input	High-speed Counter 0, direction	Normal input 2	Interrupt input 2	Quick-response input 2	–
	03	–	High-speed Counter 1, phase B or down input	High-speed Counter 1, direction	Normal input 3	Interrupt input 3	Quick-response input 3	–
	04	High-speed Counter 3, increment input	High-speed Counter 0, phase Z or reset input	High-speed Counter 0, reset input	Normal input 4	Interrupt input 4	Quick-response input 4	–
	05	High-speed Counter 4, increment input	High-speed Counter 1, phase Z or reset input	High-speed Counter 1, reset input	Normal input 5	Interrupt input 5	Quick-response input 5	–
	06	High-speed Counter 5, increment input	–	–	Normal input 6	Interrupt input 6	Quick-response input 6	Pulse 0: Origin input signal
	07	–	–	–	Normal input 7	Interrupt input 7	Quick-response input 7	Pulse 1: Origin input signal

## E14(S) or N14 CPU Units

Input terminal block		Pulse input method (Counting mode)			Other functions that cannot be used at the same time			
Terminal block label	Terminal	Increment pulse input	Differential phase ×4 or up/down input	Pulse/direction input	Normal input	Interrupt input	Quick-response input	Origin searches for pulse outputs 0 and 1
CIO 0	00	High-speed Counter 0, increment input	High-speed Counter 0, phase A or up input	High-speed Counter 0, pulse input	Normal input 0	–	–	–
	01	High-speed Counter 1, increment input	High-speed Counter 0, phase B or down input	High-speed Counter 1, pulse input	Normal input 1	–	–	–
	02	High-speed Counter 2, increment input	High-speed Counter 1, phase A or up input	High-speed Counter 0, direction	Normal input 2	Interrupt input 2	Quick-response input 2	–
	03	–	High-speed Counter 1, phase B or down input	High-speed Counter 1, direction	Normal input 3	Interrupt input 3	Quick-response input 3	Pulse 0, Origin proximity input signal
	04	High-speed Counter 3, increment input	High-speed Counter 0, phase Z or reset input	High-speed Counter 0, reset input	Normal input 4	Interrupt input 4	Quick-response input 4	–
	05	High-speed Counter 4, increment input	High-speed Counter 1, phase Z or reset input	High-speed Counter 1, reset input	Normal input 5	Interrupt input 5	Quick-response input 5	Pulse 1, Origin proximity input signal
	06	High-speed Counter 5, increment input	–	–	Normal input 6	Interrupt input 6	Quick-response input 6	Pulse 0: Origin input signal
	07	–	–	–	Normal input 7	Interrupt input 7	Quick-response input 7	Pulse 1: Origin input signal

## E10 CPU Units

Input terminal block		Pulse input method (Counting mode)			Other functions that cannot be used at the same time		
Terminal block label	Terminal	Increment pulse input	Differential phase ×4 or up/down input	Pulse/direction input	Normal input	Interrupt input	Quick-response input
CIO 0	00	High-speed Counter 0, increment input	High-speed Counter 0, phase A or up input	High-speed Counter 0, pulse input	Normal input 0	–	–
	01	High-speed Counter 1, increment input	High-speed Counter 0, phase B or down input	High-speed Counter 1, pulse input	Normal input 1	–	–
	02	High-speed Counter 2, increment input	High-speed Counter 1, phase A or up input	High-speed Counter 0, direction	Normal input 2	Interrupt input 2	Quick-response input 2
	03	–	High-speed Counter 1, phase B or down input	High-speed Counter 1, direction	Normal input 3	Interrupt input 3	Quick-response input 3
	04	High-speed Counter 3, increment input	High-speed Counter 0, phase Z or reset input	High-speed Counter 0, reset input	Normal input 4	Interrupt input 4	Quick-response input 4
	05	High-speed Counter 4, increment input	High-speed Counter 1, phase Z or reset input	High-speed Counter 1, reset input	Normal input 5	Interrupt input 5	Quick-response input 5

**Note 1** The same pulse input must be used for high-speed counter 0 and high-speed counter 1.

**2** High-speed counter 2 cannot be used if the input setting of high-speed counter 0 or high-speed counter 1 is set for differential phase inputs (4x), pulse + direction inputs, or up/down pulse inputs.

● **Wiring Example for High-speed Counter Input Terminals**

**Using a 24-VDC Open-collector Encoder**

The following example shows the connections of an encoder with phase-A, phase-B, and phase-Z inputs to high-speed counter 0.

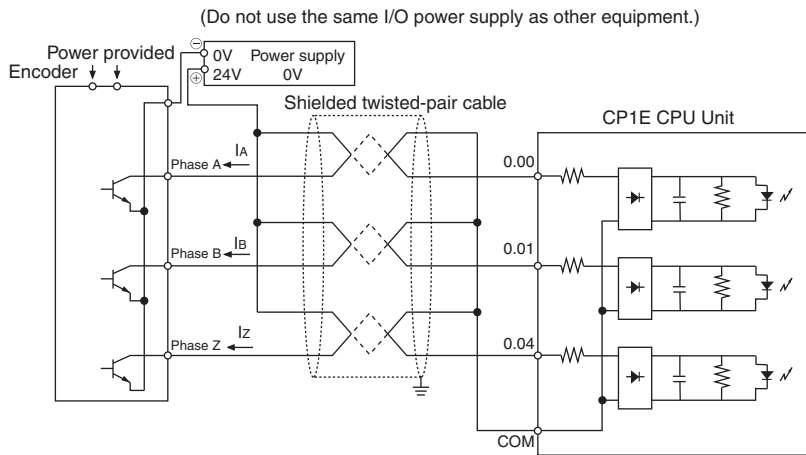
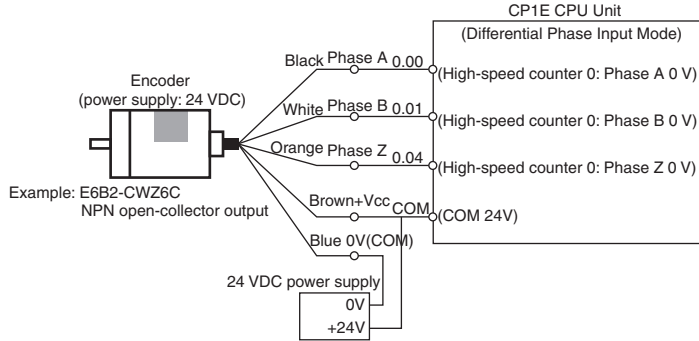

**Writing the Ladder Program**

Execution	Program	Reference
Generating interrupts for the high-speed counter PV (number of pulses) and perform high-speed processing.	Specify interrupt tasks with CTBL instructions.	11-3 High-speed Counter Interrupts
Reading the high-speed counter PV (number of pulses).	Read the high-speed counter PV from the Auxiliary Area and convert it to position or length data using instructions or measure the length using comparison instructions such as =, >, and <.	11-2-4 Reading the Present Value
Reading the high-speed counter frequency (speed).	Execute a PRV instruction.	11-2-5 Frequency Measurement

## 11-1-3 Specifications

Item		Description			
Pulse input method (Counting mode)		Increment pulse inputs	Differential phase inputs (x4)	Up/down pulse inputs	Pulse + direction inputs
Input signal		Increment	Phase-A	Up pulse	Pulse
		–	Phase-B	Down pulse	Direction
		–	Phase-Z	Reset	Reset
Frequency and number of high-speed counters	N/NA□□(S) □□-type CPU Unit	100 kHz: 2 counters, 10 kHz: 4 counters	50 kHz: 1 counter, 5 kHz: 1 counter	100 kHz: 1 counter, 10 kHz: 1 counter	100 kHz: 2 counters
	E□□(S)-type CPU Unit	E10 CPU Unit: 10 kHz: 5 counters E14/20/30/40/60(S) CPU Unit: 10 kHz: 6 counters	5 kHz: 2 counters	10 kHz: 2 counters	10 kHz: 2 counters
Counting mode		Linear mode or circular (ring) mode			
Count values		Linear mode: 8000 0000 to 7FFF FFFF hex Ring Mode: 0000 0000 to Ring SV			
High-speed counter PV storage locations		High-speed counter 0: A271 (upper 4 digits) and A270 (lower 4 digits) High-speed counter 1: A273 (upper 4 digits) and A272 (lower 4 digits) High-speed counter 2: A317 (upper 4 digits) and A316 (lower 4 digits) High-speed counter 3: A319 (upper 4 digits) and A318 (lower 4 digits) High-speed counter 4: A323 (upper 4 digits) and A322 (lower 4 digits) High-speed counter 5: A325 (upper 4 digits) and A324 (lower 4 digits)  The PVs are refreshed in the overseeing processes at the start of each cycle. Use PRV to read the most recent PVs.			
		Data format: 8 digit hexadecimal <ul style="list-style-type: none"> <li>Range in linear mode: 8000 0000 to 7FFF FFFF hex</li> <li>Range in Ring Mode: 0000 0000 to Ring SV (Circular Max. Count)</li> </ul>			
Control method	Target value comparison	Up to 6 target values and corresponding interrupt task numbers can be registered.			
	Range comparison	Up to 6 ranges can be registered, with a separate upper limit, lower limit, and interrupt task number for each range.			
Counter reset method		<ul style="list-style-type: none"> <li>Phase-Z + Software reset The high-speed counter is reset when the phase-Z signal goes ON while the Reset Bit (A531.00 to A531.05) is ON. (Phase Z cannot be used for the increment pulse.)</li> <li>Software reset The high-speed counter is reset when the Reset Bit (A531.00 to A531.05) is turned ON.</li> </ul> <p>Operation can be set to stop or continue the comparison operation when the high-speed counter is reset.</p>			

# 11-2 High-speed Counter Inputs

## 11-2-1 Pulse Input Methods Settings

There are four pulse input methods for high-speed counters.

- Increment pulse input
- Differential phase input (4x)
- Up/Down pulse input
- Pulse+direction input

### Increment Pulse Input

The Increment Pulse Input counts signals on a single-phase pulse input. Only incrementing the count is possible in this mode.

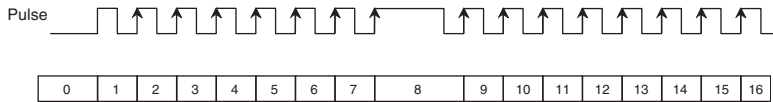

Conditions for Incrementing the Count

Pulse	Count value
OFF→ON	Increment
ON	No change
ON→OFF	No change
OFF	No change

• Only rising edges are counted.

### Differential Phase Input (4x)

The Differential Phase Input uses two phase signals (phase A and phase B) and increments/decrements the count according to the status of Differential Phase (4x).

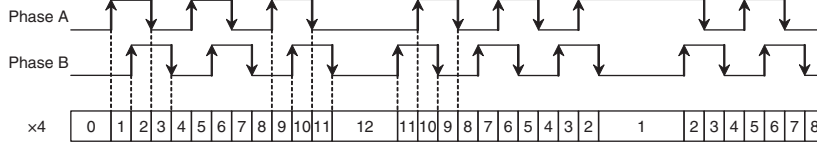

Conditions for Incrementing/Decrementing the Count

Phase A	Phase B	Count value
OFF→ON	OFF	Increment
ON	OFF→ON	Increment
ON→OFF	ON	Increment
OFF	ON→OFF	Increment
OFF	OFF→ON	Decrement
OFF→ON	ON	Decrement
ON	ON→OFF	Decrement
ON→OFF	OFF	Decrement

### Up/Down Pulse Input

The Up/Down Pulse Input uses two signals, an increment pulse and a decrement pulse.

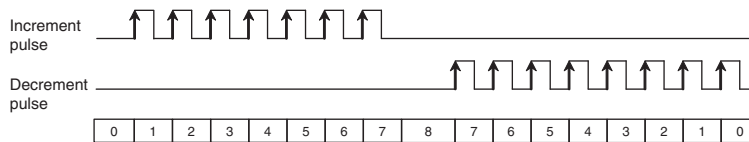

Conditions for Incrementing/Decrementing the Count

Decrement pulse	Increment pulse	Count value
OFF→ON	OFF	Decrement
ON	OFF→ON	Increment
ON→OFF	ON	No change
OFF	ON→OFF	No change
OFF	OFF→ON	Increment
OFF→ON	ON	Decrement
ON	ON→OFF	No change
ON→OFF	OFF	No change

• The count is incremented for each increment pulse and decremented for each decrement pulse.  
• Only rising edges are counted.

## Pulse + Direction Input

The Pulse + Direction Input uses a direction signal and a pulse signal. The count is incremented or decremented depending on the status (ON or OFF) of the direction signal.

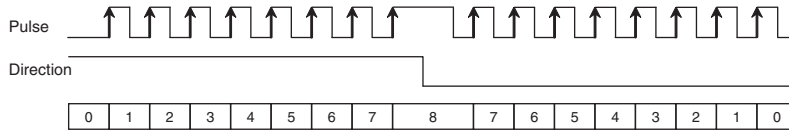

Conditions for Incrementing/Decrementing the Count

Direction	Pulse	Count value
OFF→ON	OFF	No change
ON	OFF→ON	Increment
ON→OFF	ON	No change
OFF	ON→OFF	No change
OFF	OFF→ON	Decrement
OFF→ON	ON	No change
ON	ON→OFF	No change
ON→OFF	OFF	No change

- The count is incremented when the direction signal is ON and decremented when it is OFF.
- Only rising edges are counted.



### Precautions for Correct Use

- Interval of Phase-Z input signal  
Do not input the phase-Z signal at a high frequency. The interval of phase-Z input signal must be longer than 500µs.  
If the phase-Z signal is input at a high frequency, cycle time exceeded error may occur.

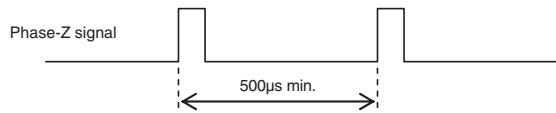

- Interval of direction changing  
If the input setting is set for pulse+direction inputs, do not change the direction at a high frequency. The interval of direction signal ON or OFF must be longer than 3ms plus the sum of execution time for interrupt tasks that may possibly happen at the same time. (For CPU Unit version 1.0 or earlier, the interval must be longer than 6 ms plus the sum of execution time for interrupt tasks that may possibly happen at the same time.)  
The sum of execution time for interrupt tasks in one cycle is stored in A442.  
If the direction signal is ON or OFF at a high frequency, count values may not agree.  
Cycle time exceeded error possibly occurs when changing the direction at a high frequency. Therefore, please do not connect chattering equipment as direction signal input such as relay and switch.

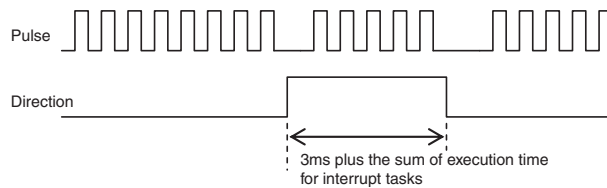

- Interval of pulse input after direction changing  
If the input setting is set for pulse+direction inputs, the Interval of pulse input after the direction changing must be longer than 500µs.  
If the pulse is output immediately after the direction changing, count values may not agree.

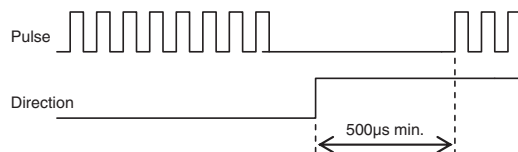



**Additional Information**

The count of a high-speed counter can be monitored to see if it is currently being incremented or decremented. The count in the current cycle is compared with the count in the previous cycle to determine if it is being incremented or decremented.

The results are reflected in the High-speed Counter Count Direction Flags.

High-speed counter	Address of High-speed Counter Count Direction Flag
High-speed counter 0	A274.10
High-speed counter 1	A275.10
High-speed counter 2	A320.10
High-speed counter 3	A321.10
High-speed counter 4	A326.10
High-speed counter 5*	A327.10

\* High-speed counter 5 is not supported by E10 CPU Units.

## 11-2-2 Counting Ranges Settings

The following counting modes can be selected for high-speed counters: Linear Mode that counts in a fixed range and Circular (Ring) Mode that counts in a set range of any maximum value.

### Linear Mode

Input pulses can be counted in the range between the lower limit and upper limit values. If the pulse count goes beyond the lower/upper limit, an underflow/overflow will occur and counting will stop.

- Increment Mode



- Up/Down Mode

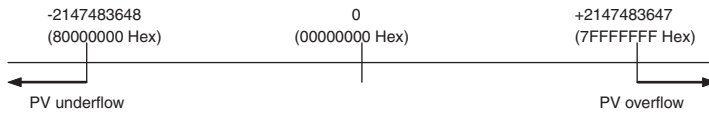



## Circular (Ring) Mode

Input pulses are counted in a loop within the set range.

- If the count is incremented from the maximum ring count, the count will be reset to 0 automatically and incrementing will continue.
- If the count is decremented from 0, the count will be set to the maximum ring count automatically and decrementing will continue.

Consequently, underflows and overflows cannot occur when Ring Mode is used.

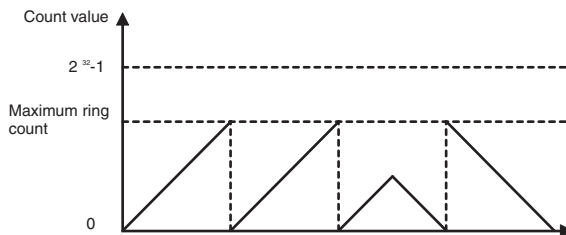

### ● Maximum Ring Count

Use the PLC Setup to set the maximum ring count (Circular Max. Count), which is the maximum value of the input pulse counting range. The maximum ring count can be set to any value between 0000 0001 and FFFF FFFF hex (1 to 4,294,967,295 decimal).



### Precautions for Correct Use

- There are no negative values in Ring Mode.
- If the maximum ring count is set to 0 in the PLC Setup, the counter will operate with a maximum ring count of FFFF FFFF hex.

## 11-2-3 Reset Methods

It is called reset that a high-speed counter's PV is set to 0.

There are two reset methods

- Phase-Z signal + software reset
- software reset

## Phase-Z Signal + Software Reset

The high-speed counter's PV is reset when the phase-Z signal (reset input) goes from OFF to ON while the corresponding High-speed Counter Reset Bit (A531.00 to A531.05) is ON.

The CPU Unit recognizes the ON status of the High-speed Counter Reset Bit only at the beginning of the PLC cycle during the overseeing processes. Consequently, when the Reset Bit is turned ON in the ladder program, the phase-Z signal does not become effective until the next PLC cycle.

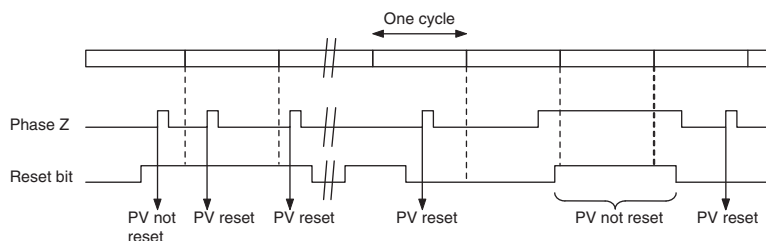

**Note** The phase-Z signal cannot be used if an incremental counter is specified. Only a software reset can be used.

## Software Reset

The high-speed counter's PV is reset when the corresponding High-speed Counter Reset Bit (A531.00 to A531.05) goes from OFF to ON.

The CPU Unit recognizes the OFF-to-ON transition of the High-speed Counter Reset Bit only at the beginning of the PLC cycle during the overseeing processes. Reset processing is performed at the same time. The OFF-to-ON transition will not be recognized if the Reset Bit goes OFF again within the same cycle.

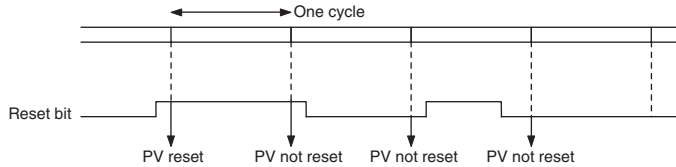

### Additional Information

The comparison operation can be selected to stop or continue in the PLC Setup when a high-speed counter is reset. This enables applications where the comparison operation can be restarted from a counter PV of 0 when the counter is reset.

## 11-2-4 Reading the Present Value

The present value of a high-speed counter can be read in the following two ways.

- Value refreshed at the I/O refresh timing → Read PV from Auxiliary Area.
- Value updated when a ladder program is executed → Read PV by executing a PRV instruction.

## Reading the Value Refreshed at the I/O Refresh Timing

The PV that is stored in the following words can be read using the MOVL instruction or other instructions.

Read PV	Auxiliary Area word
High-speed counter 0	A271 (upper digits) and A270 (lower digits)
High-speed counter 1	A273 (upper digits) and A272 (lower digits)
High-speed counter 2	A317 (upper digits) and A316 (lower digits)
High-speed counter 3	A319 (upper digits) and A318 (lower digits)
High-speed counter 4	A323 (upper digits) and A322 (lower digits)
High-speed counter 5*	A325 (upper digits) and A324 (lower digits)

\* High-speed counter 5 is not supported by E10 CPU Units.

## Reading the Value When a Ladder Program is Executed

### ● Reading the High-speed Counter PV with a PRV Instruction

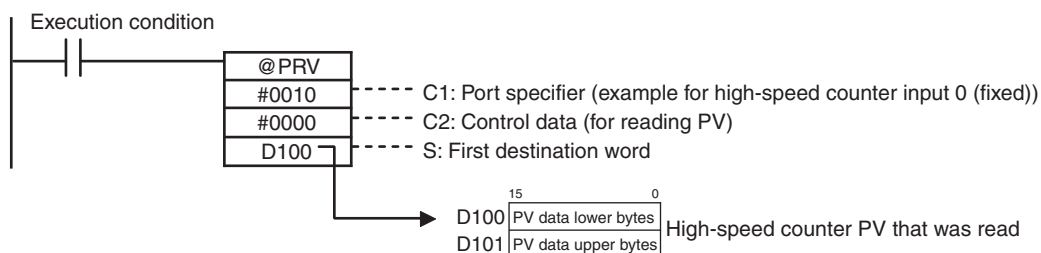

## 11-2-5 Frequency Measurement

### Overview

This function measures the frequency of the high-speed counter (input pulses.)

The input pulse frequency can be read by executing the PRV instruction. The measured frequency is output in 8-digit hexadecimal and expressed in Hz. The frequency measurement function can be used with high-speed counter 0 only.

The frequency can be measured while a high-speed counter 0 comparison operation is in progress. Frequency measurement can be performed at the same time as functions such as the high-speed counter and pulse output without affecting the performance of those functions.

#### ● Reading the High-speed Counter Frequency with a PRV Instruction

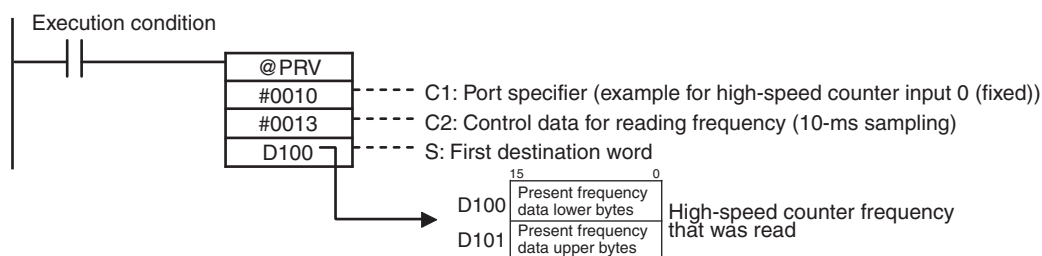

#### Precautions for Correct Use

The frequency measurement function can be used with high-speed counter 0 only.

#### ● Specifications

Item	Specifications
Number of frequency measurement inputs	1 input (high-speed counter 0 only)
Frequency measurement range	High-speed counter 0: Differential phase inputs: 0 to 50 kHz All other input modes: 0 to 100 kHz*
Measurement method	Execution of the PRV instruction
Stored data	Unit: Hz
Output data range	Differential phase input: 0000 0000 to 0003 0D40 hex All other input modes: 0000 0000 to 0001 86A0 hex

\* If the frequency exceeds the maximum value, the maximum value will be stored.

# 11-3 High-speed Counter Interrupts

High-speed counter interrupts can be used with any model of CP1E CPU Unit.

## 11-3-1 Overview

This function counts input pulses with the CPU Unit's built-in high-speed counter and executes an interrupt task when the count reaches the preset value or falls within a preset range (target-value or zone comparison). An interrupt task between 0 and 15 can be allocated with the CTBL instruction.

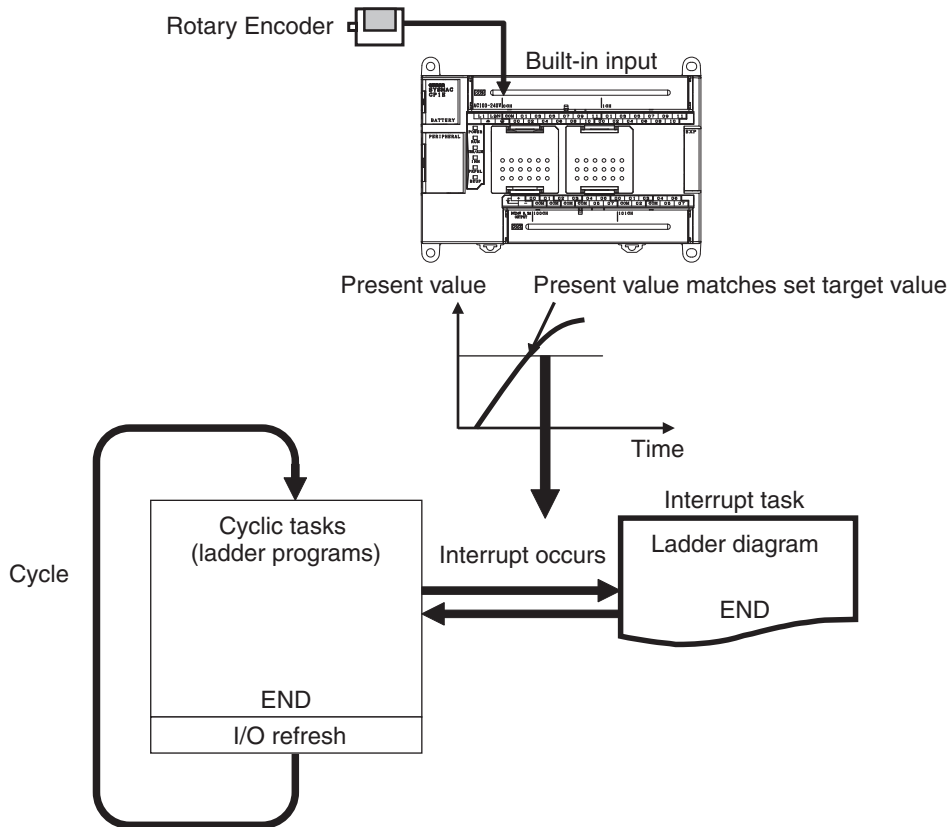

Target value comparison	Range comparison
<p>The specified interrupt program can be started when the present value of the high-speed counter matches a target value.</p>	<p>The specified interrupt program can be started when the present value of the high-speed counter enters a set range.</p>

## Flow of Operation

1



2

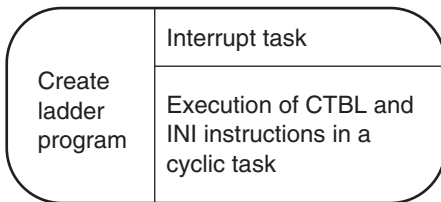

- Enable the required high-speed counters.
- Select the *Use high speed counter* Check Box for high-speed counters 0 to 5. Set the input setting, counting mode and reset method on the Built-in Tab Page of the PLC Setup using the CX-Programmer.
- Terminals 00 to 06 on the 0CH terminal block can be used for high-speed counters. High-speed counters 0 to 5 correspond to terminals 00 to 05.

Write a program for interrupt tasks 0 to 15.

- Set the comparison values for the high-speed counter and the interrupt tasks (0 to 15) to be started using the CTBL instruction.
- Start the comparison using the INI instruction. The comparison can be started simultaneously when registering the comparison values using the CTBL instruction.

### ● High-speed Counter Interrupts Settings

Setting in PLC Setup on Built-in Input Tab Page		Instruction	CTBL port specifier (C1)	Interrupt task number
High-speed counter 0	Select <i>Use</i> Check Box.	CTBL	#0000	0 to 15 (Specified by user.)
High-speed counter 1			#0001	
High-speed counter 2			#0002	
High-speed counter 3			#0003	
High-speed counter 4			#0004	
High-speed counter 5*			#0005	

\* High-speed counter 5 is not supported by E10 CPU Units.



#### Precautions for Correct Use

A built-in input cannot be used as a normal input, interrupt input, or quick-response input if it is being used as a high-speed counter input. Refer to 8-3-3 *Allocating Built-in Input Terminals* for details.

## PLC Setup

Click the Built-in Input Tab and select the *Use high-speed counter* Check Box for high-speed counters 0 to 5, and then set the counting mode, reset method, and input setting.

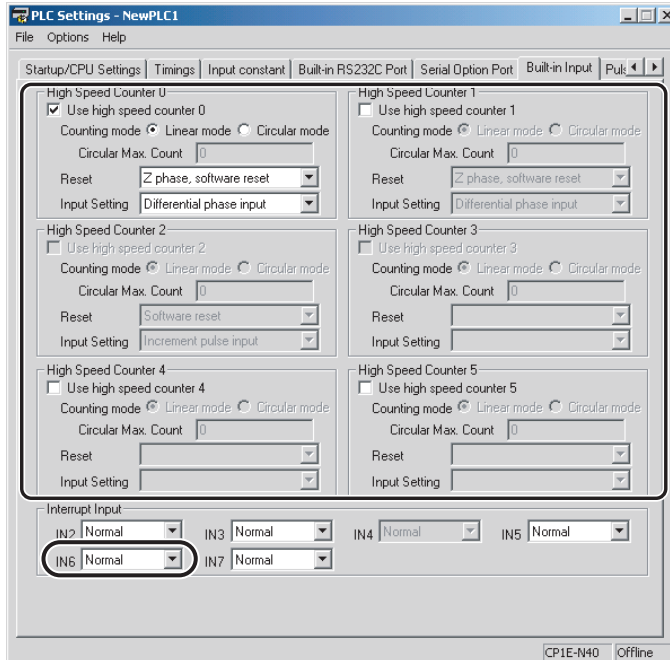

Refer to *11-1-2 Flow of Operation* in Page 11-3 for details.

## Determining High-speed Counter

High-speed counters 0 to 5 can be used for high-speed counter interrupts.

- Refer to *8-3-3 Allocating Built-in Input Terminals* for high-speed counter interrupt.
- Refer to *10-1 Interrupts* for the interrupts excluding high-speed counter interrupts.

## Writing the Ladder Program

### ● Writing the Interrupt Task Program

Create programs for interrupt tasks 0 to 15, which are executed for the corresponding high-speed counter interrupts. Right-click a program in the CX-programmer and select **Properties**. Select any interrupt task in the **Task type** Field of the **Program Properties** Dialog Box.

● Execution of CTBL and INI Instructions for Cyclic Task

Execute the instructions in the following order.

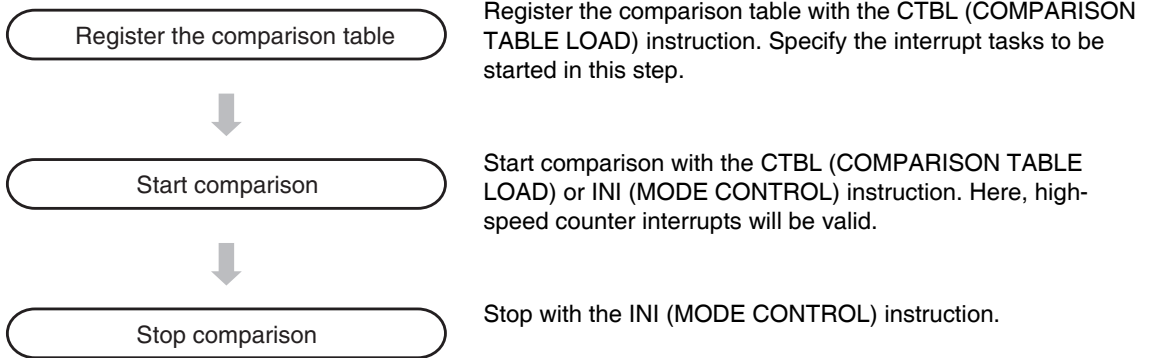

Refer to 11-3-2 Present Value Comparison for details.

11-3-2 Present Value Comparison

The comparison of the high-speed counter PV has the following two ways: Target Value Comparison and Range Comparison.

Target Value Comparison

The specified interrupt task is executed when the high-speed counter PV matches a target value registered in the table.

- The comparison conditions (target values and counting directions) are registered in the comparison table along with the corresponding interrupt task number. The specified interrupt task will be executed when the high-speed counter PV matches the registered target value.
- Comparison is executed in the order set in the comparison table. Once comparison has cycled through the comparison table, it will return and wait for a match with the first target value again.

The following examples show the operation of an interrupt task for a comparison table.

Example 1

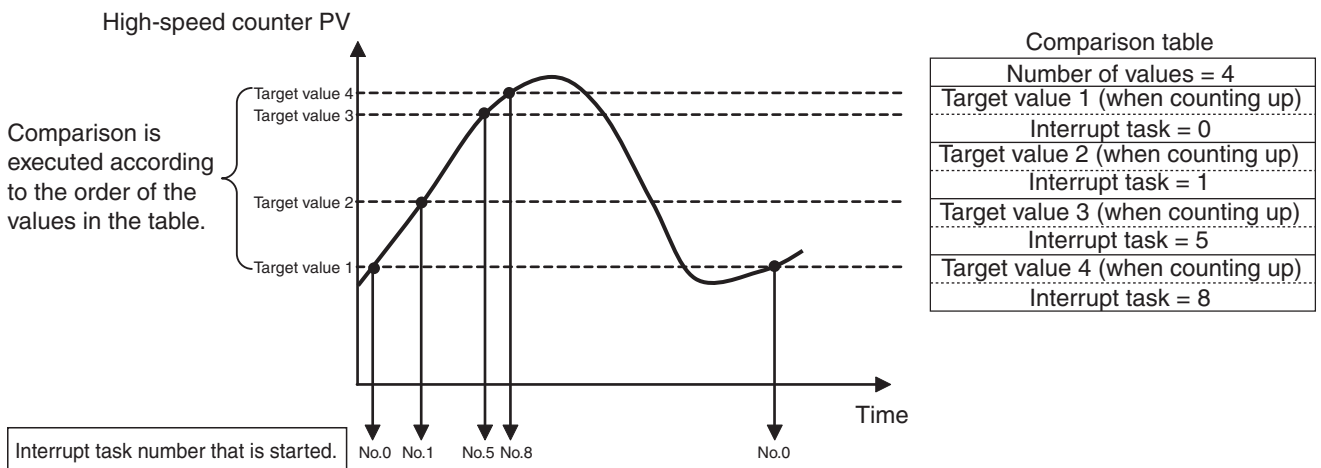

Example 2

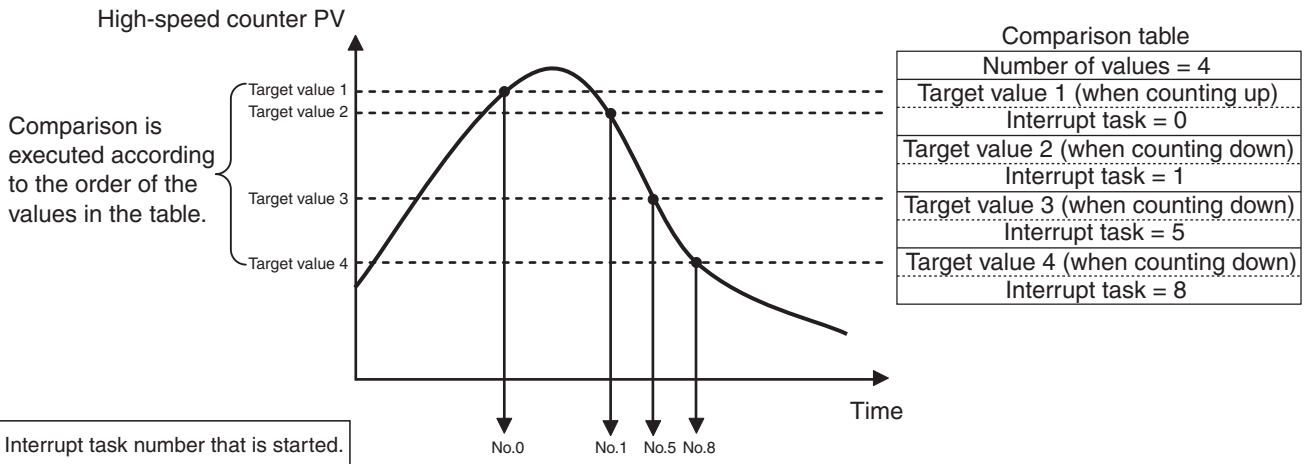

- Up to 6 target values (between 1 and 6) can be registered in the comparison table.
- A different interrupt task can be registered for each target value.
- If the PV is changed, the changed PV will be compared with the target values in the table, even if the PV is changed while the target value comparison operation is in progress.



**Precautions for Correct Use**

- When the count direction (incrementing/decrementing) changes at a PV that matches a target value or a count after a target value, the next target value cannot be matched in that direction. Set the target values so that they do not occur at the peak or trough of count value changes.

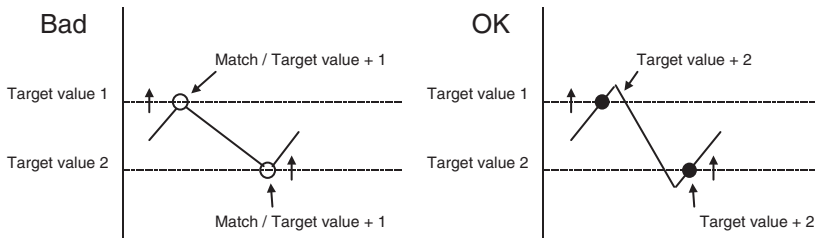

- The maximum response frequencies of the high-speed counters are given in the following table.

Item		E□□(S)-type CPU Unit	N/NA□□(S)-type CPU Unit
High-speed counter 0	Incremental pulse	10kHz	100kHz
	Up and down pulses		
	Pulse plus direction		
	Differential phase (x4)		
High-speed counter 1	Incremental pulse	5kHz	100kHz
	Up and down pulses		10kHz
	Pulse plus direction		100kHz
	Differential phase (x4)		5kHz
High-speed counter 2	Incremental pulse	10kHz	10kHz
High-speed counter 3	Incremental pulse		
High-speed counter 4	Incremental pulse		
High-speed counter 5*	Incremental pulse		

\* High-speed counter 5 is not supported by E10 CPU Units.





**Precautions for Correct Use**

- There are restrictions on the maximum response frequencies of the high-speed counters when using target matching. Use the counters for target matching under the frequencies in the following table. If the pulse frequencies input to the high-speed counters are higher than those in the table, count values may not agree.

For unit version 1.0

Counter numbers for target matching	Increment pulse Pulse plus direction Up and down pulses	Differential phase (x4)
More than 1 point	20kHz max.	5kHz max.

For unit version 1.1

Enabling/Disabling pulse outputs	Counter numbers for target matching	Increment pulse Pulse plus direction Up and down pulses	Differential phase (x4)
Disabling pulse outputs	Only one point	100kHz max.	30kHz max.
	More than two points	60kHz max.	15kHz max.
Enabling pulse outputs	Only one point	50kHz max.	10kHz max.
	More than two points	40kHz max.	

- When using target matching, the interval between interrupts for target matches and the interval between interrupts for the next target matches after the count direction (incrementing/decrementing) changing must be longer than 3 ms plus the sum of execution time for interrupt tasks that may possibly happen at the same time. The sum of execution time for interrupt tasks in one cycle is stored in A442. (For CPU Unit version 1.0 or earlier, the interval must be longer than 6 ms plus the sum of execution time for interrupt tasks that may possibly happen at the same time and the data in A442 is unstable.)
- If the input setting is set for up/down pulse inputs or differential phase inputs (x4), do not change the direction at a high frequency when using target matching. If changing direction at a high frequency, the interval of direction changing must be longer than 500µs. If changing direction at a high frequency when using target matching, cycle time exceeded error may occur. There is no restriction when target matching is not used.

Example: Up/down pulse inputs

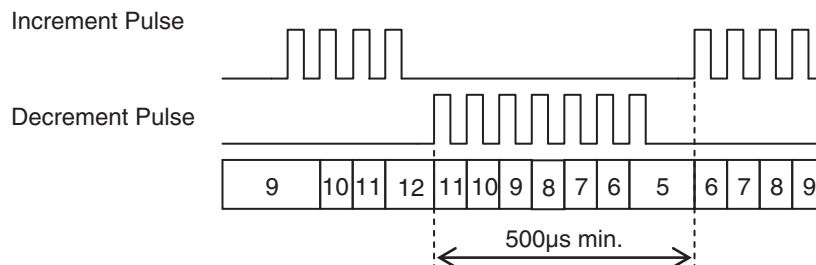

- Cycle time exceeded error occurs when using target matching. When using target matching, if the encoder input values change fast due to vibration, the direction changing may be at a high frequency, cycle time exceeded error may occur as a result. At this time, take measures to stabilize the encoder inputs or use range comparison.

## Range Comparison

The specified interrupt task is executed when the high-speed counter PV is within the range defined by the upper and lower limit values.

- The comparison conditions (upper and lower limits of the range) are registered in the comparison table along with the corresponding interrupt task number. The specified interrupt task will be executed once when the high-speed counter PV is in the range ( $\text{Lower limit} \leq \text{PV} \leq \text{Upper limit}$ ).

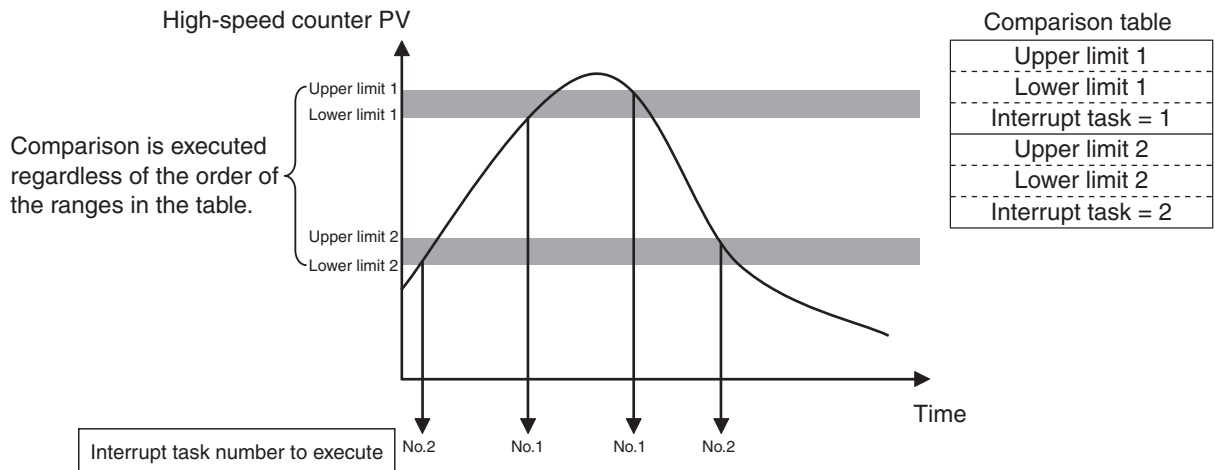

- A total of 6 ranges (upper and lower limits) are registered in the comparison table.
- The ranges can overlap.
- A different interrupt task can be registered for each range.
- The counter PV is compared with the 6 ranges once each cycle.
- The interrupt task is executed just once when the comparison condition goes from unmet to met.



### Precautions for Correct Use

When more than one comparison condition is met in a cycle, the first interrupt task in the table will be executed in that cycle. The next interrupt task in the table will be executed in the next cycle.



### Additional Information

The range comparison table can be used without starting an interrupt task when the comparison condition is met. The range comparison function can be useful when you just want to know whether or not the high-speed counter PV is within a particular range.

Use the Range Comparison Condition Met Flags to determine whether the high-speed counter PV is within a registered range.

### 11-3-3 High-speed Counter Interrupt Instruction

#### COMPARISON TABLE LOAD Instruction: CTBL

The CTBL instruction compares the PV of a high-speed counter (0 to 5) to target values or ranges and executes the corresponding interrupt task (0 to 15) when the specified condition is met.

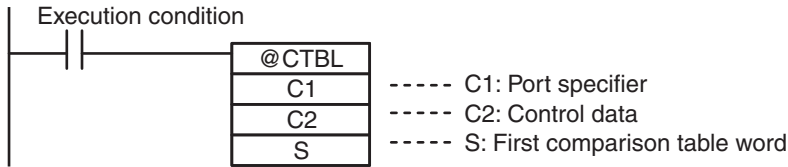

Operand		Settings	
C1	Port specifier	#0000	High-speed counter 0
		⋮	⋮
		#0005	High-speed counter 5
C2	Control data	#0000	Registers a target-value comparison table and starts the comparison operation.
		#0001	Registers a range comparison table and starts the comparison operation.
		#0002	Registers a target-value comparison table.
		#0003	Registers a range comparison table.
S	First comparison table word	Specifies the first word address of the comparison table, which is described below.	

#### ● Contents of the Comparison Table

- Target-value Comparison Table

Depending on the number of target values in the table, the target-value comparison table requires a continuous block of 4 to 19 words.

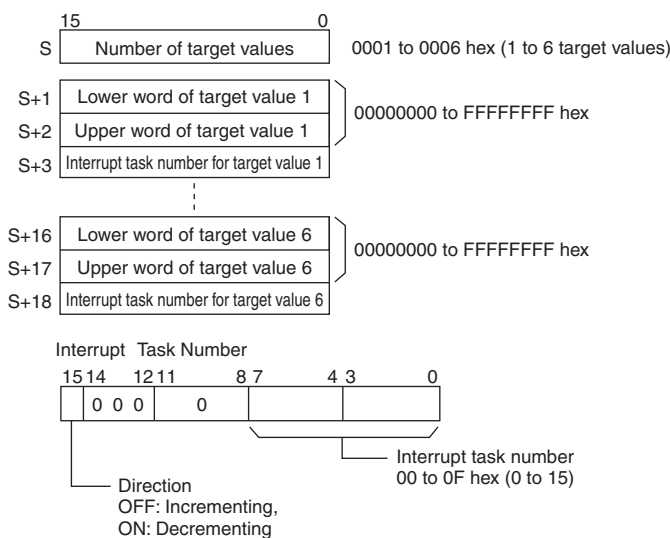

• Range Comparison Table

The range comparison table requires a continuous block of 30 words for comparison conditions 1 to 6 require 5 words each (two words for the upper range value, two words for the lower range value, and one word for the interrupt task number).

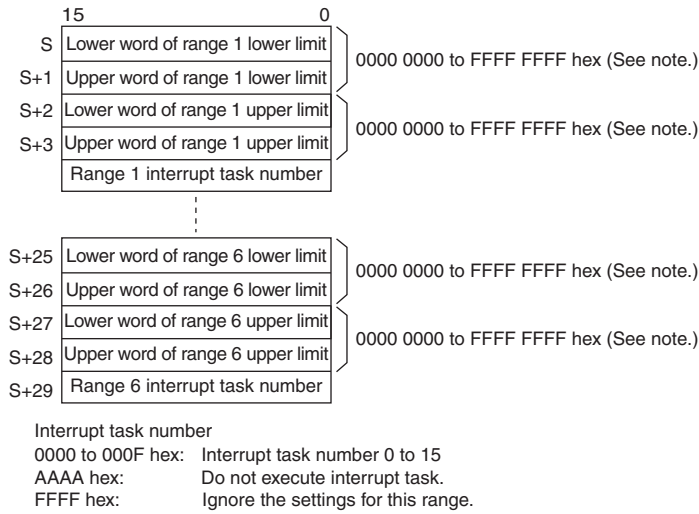

**Note** Always set the upper limit greater than or equal to the lower limit for any one range.

## MODE CONTROL Instruction: INI

The INI instruction is used for the following items.

- Starting and stopping comparison with the high-speed counter comparison table  
Use the CTBL instruction to register the target value or range comparison table before using INI to start or stop comparison.

If the comparison is started simultaneously when registering the comparison table and then the high-speed counter interrupts are always valid, the INI instruction is not required.

- Changing the PV of a High-speed Counter

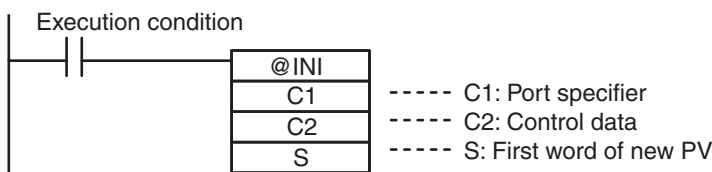

Operand		Settings	
C1	Port specifier	#0010	High-speed counter 0
		?	?
		#0015	High-speed counter 5
C2	Control data	#0000	Start comparison.
		#0001	Stop comparison.
		#0002	Change the PV.
S	First word of new PV	S contains the first word of the new PV when C is set to #0002 (change the PV).	

## Example 1: Target Value Comparison

In this example, high-speed counter 0 operates in linear mode and starts interrupt task 10 when the PV reaches 30,000 (0000 7530 hex) and starts interrupt task 11 when the PV reaches 20,000 (0000 4E20 hex).

- 1** Set high-speed counter 0 in the PLC Setup's Built-in Input Tab.

Item	Setting
High-speed counter 0	Use counter
Counting mode	Linear mode
Circular Max. Count	–
Reset method	Software reset
Input Setting	Up/Down inputs

- 2** Set the target-value comparison table in words D1000 to D1006.

Word	Setting	Function	
D1000	#0002	Number of target values = 2	
D1001	#7530	Rightmost 4 digits of the target value 1 data (30000)	Target value = 30,000(0000 7530 hex)
D1002	#0000	Leftmost 4 digits of the target value 1 data (30000)	
D1003	#000A	Target value 1 Bit 15: 0 (incrementing) Bits 00 to 07: A hex (interrupt task number 10)	
D1004	#4E20	Rightmost 4 digits of the target value 2 data (20000)	Target value = 20,000(0000 4E20 hex)
D1005	#0000	Leftmost 4 digits of the target value 2 data (20000)	
D1006	#800B	Target value 2 Bit 15: 1 (decrementing) Bits 00 to 07: B hex (interrupt task number 11)	

- 3** Create the programs for interrupt tasks 10 and 11.

- 4** Use the CTBL instruction to start the comparison operation with high-speed counter 0 and interrupt tasks 10 and 11.

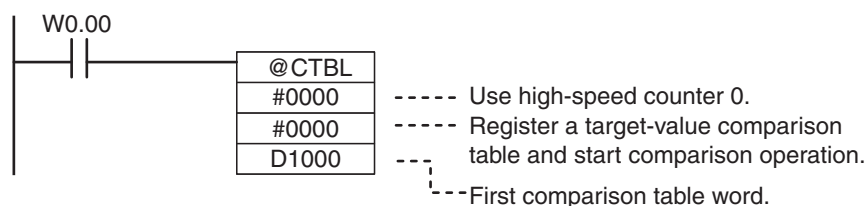

When execution condition W0.00 turns ON, the comparison starts with high-speed counter 0.

When the PV of high speed counter 0 reaches 30,000, cyclic task execution is interrupted, and interrupt task 10 is executed.

When the PV of high speed counter 0 reaches 20,000, cyclic task execution is interrupted, and interrupt task 11 is executed.

When interrupt task 10 or 11 execution has been completed, execution of the interrupted cyclic task resumes.

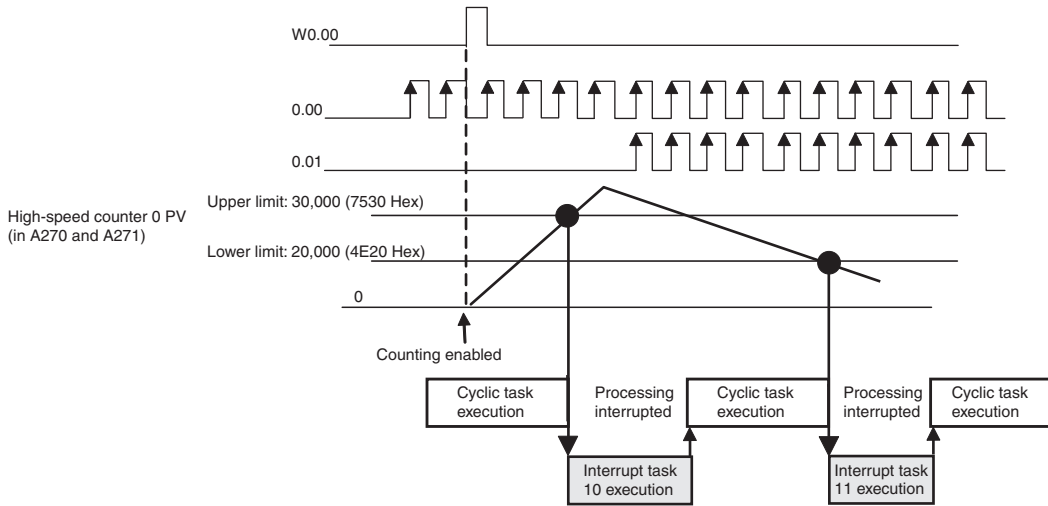

## Example 2: Range Comparison

In this example, high-speed counter 1 operates in circular (ring) mode and starts interrupt task 12 when the PV is between 25,000 (0000 61A8 hex) and 25,500 (0000 639C hex).

The maximum ring count is set to 50,000 (0000 C350 hex).

- 1 Set high-speed counter 1 on the PLC Setup's Built-in Input Tab Page.

Item	Setting
High-speed counter 1	Use counter
Counting mode	Circular mode
Circular Max. Count	50,000
Reset method	Software reset (continue comparing)
Input Setting	Up/Down inputs

- 2 Set the range comparison table starting at word D2000. Even though range 1 is the only range being used, all 30 words must still be dedicated to the range comparison table.

Word	Setting	Function
D2000	#61A8	Rightmost 4 digits of range 1 lower limit
D2001	#0000	Leftmost 4 digits of range 1 lower limit
D2002	#639C	Rightmost 4 digits of range 1 upper limit
D2003	#0000	Leftmost 4 digits of range 1 upper limit
D2004	#000C	Range 1 interrupt task number = 12 (C hex)
D2005 to D2008	All #0000	Range 2 lower and upper limit values (Not used and do not need to be set.)
D2009	#FFFF	Disables range 2.
D2014, D2019, D2024, D2029	#FFFF	Set the fifth word for ranges 3 to 6 (listed at left) to #FFFF (Range settings are invalid) to disable those ranges.

- 3** Create the program for interrupt task 12.
- 4** Use the CTBL instruction to start the comparison operation with high-speed counter 1 and interrupt task 12.

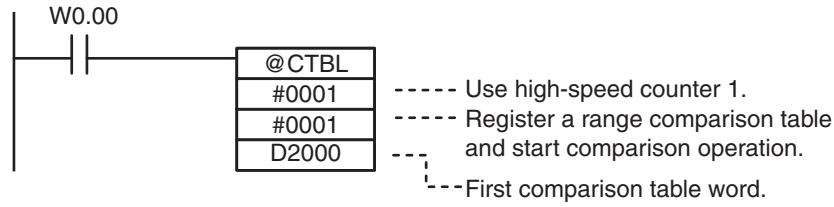

When execution condition W0.00 turns ON, the comparison starts with high-speed counter 1.

When the PV of high speed counter 1 is between 25,000 and 25,500, cyclic task execution is interrupted, and interrupt task 12 is executed.

When interrupt task 12 execution is completed, execution of the interrupted cyclic task resumes.

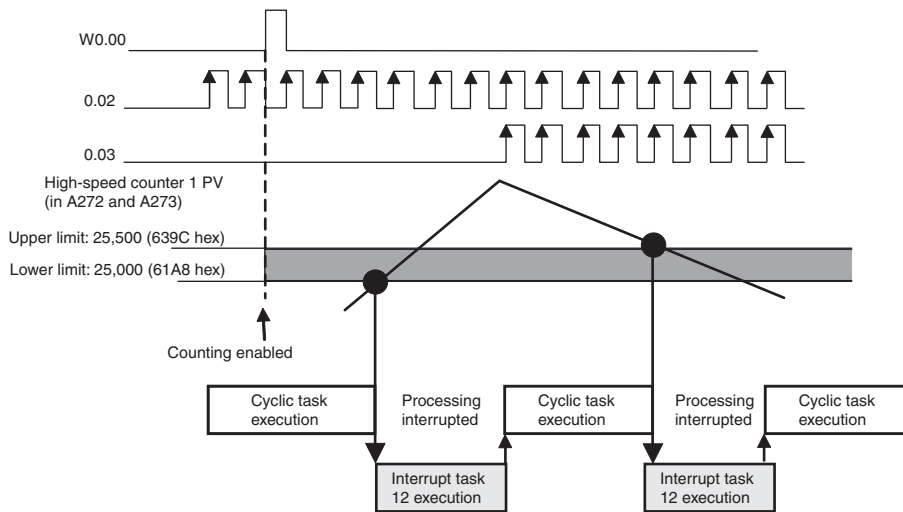

## 11-4 Related Auxiliary Area Bits and Words

### Bits and Words Allocated in the Auxiliary Area

Contents		High-speed counter 0	High-speed counter 1	High-speed counter 2	High-speed counter 3	High-speed counter 4	High-speed counter 5*
High-speed counter PV storage words	Leftmost 4 digits	A271	A273	A317	A319	A323	A325
	Rightmost 4 digits	A270	A272	A316	A318	A322	A324
Range Comparison Condition Met Flags	Range 1 Comparison Condition Met Flag (ON for match.)	A274.00	A275.00	A320.00	A321.00	A326.00	A327.00
	Range 2 Comparison Condition Met Flag (ON for match.)	A274.01	A275.01	A320.01	A321.01	A326.01	A327.01
	Range 3 Comparison Condition Met Flag (ON for match.)	A274.02	A275.02	A320.02	A321.02	A326.02	A327.02
	Range 4 Comparison Condition Met Flag (ON for match.)	A274.03	A275.03	A320.03	A321.03	A326.03	A327.03
	Range 5 Comparison Condition Met Flag (ON for match.)	A274.04	A275.04	A320.04	A321.04	A326.04	A327.04
	Range 6 Comparison Condition Met Flag (ON for match.)	A274.05	A275.05	A320.05	A321.05	A326.05	A327.05
Comparison In-progress Flags	ON when a comparison operation is being executed for the high-speed counter.	A274.08	A275.08	A320.08	A321.08	A326.08	A327.08
Overflow/Underflow Flags	ON when an overflow or underflow has occurred in the high-speed counter's PV.	A274.09	A275.09	A320.09	A321.09	A326.09	A327.09
Count Direction Flags	0: Decrementing 1: Incrementing	A274.10	A275.10	A320.10	A321.10	A326.10	A327.10
High-speed Counter Reset Flags	ON at a software reset	A531.00	A531.01	A531.02	A531.03	A531.04	A531.05

\* High-speed counter 5 is not supported by E10 CPU Units.



# 11-5 Application Example

## Using a Rotary Encoder to Measure Positions

### ● Functions Used: High-speed Counting for a Built-in Input

A high-speed counter input can be used by connecting a rotary encoder to a built-in input. A CP1E CPU Unit is equipped with more than one high-speed counter input, making it possible to control devices for multiple axes with a single PLC.

High-speed counters can be used for high-speed processing, using either target value comparison or range comparison to create interrupts. Interrupt tasks are executed when the counter value reaches a specific target value or range.

### ● Operation Overview

A sheet feeder is controlled to feed constant lengths in a given direction, e.g., for vacuum packing of food products.

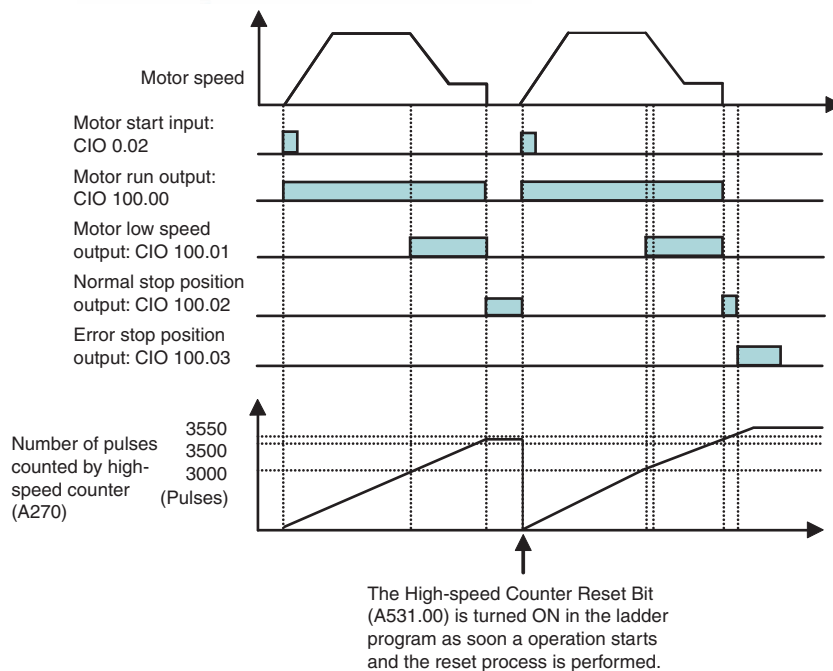

While the pulse count is between 3,500 and 3,550, normal stop position output (CIO 100.02) will be ON. If the pulse count exceeds 3,550, the error stop position output (CIO 100.03) will turn ON.

● System Configuration

Wiring Example

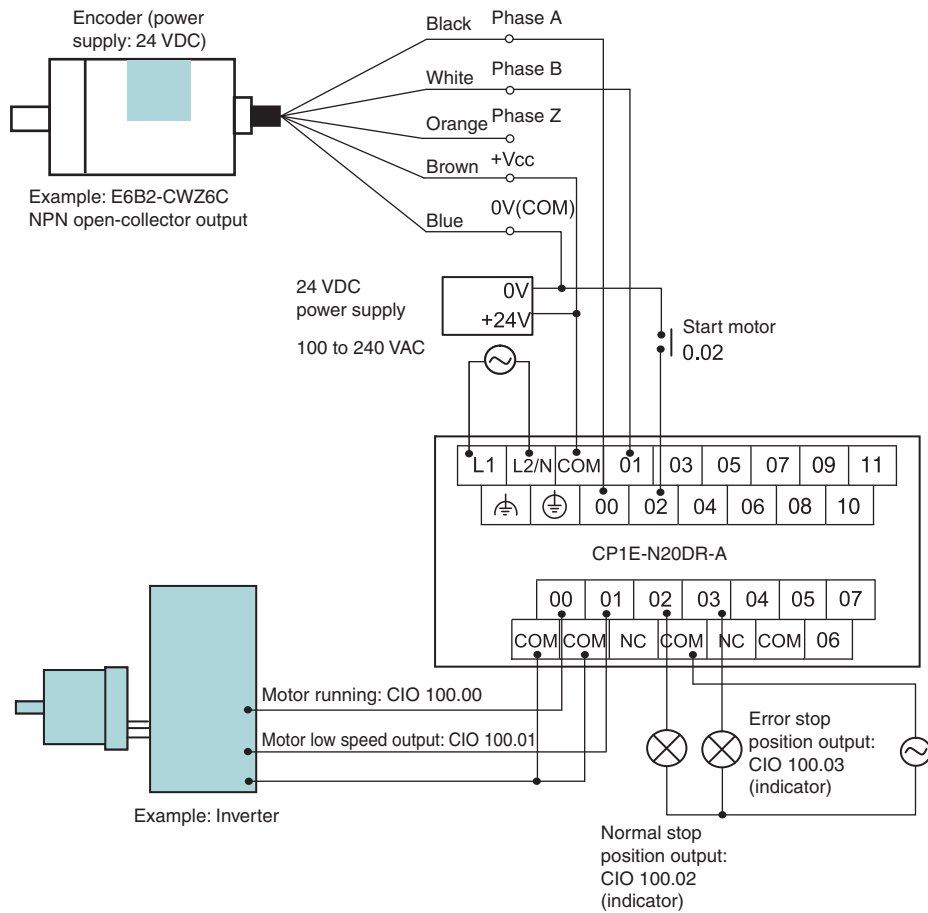

PLC Setup

Use the following procedure to enable high-speed counter 0.

- 1 Open the PLC Settings Dialog Box.
- 2 Click the Built-in Input Tab.

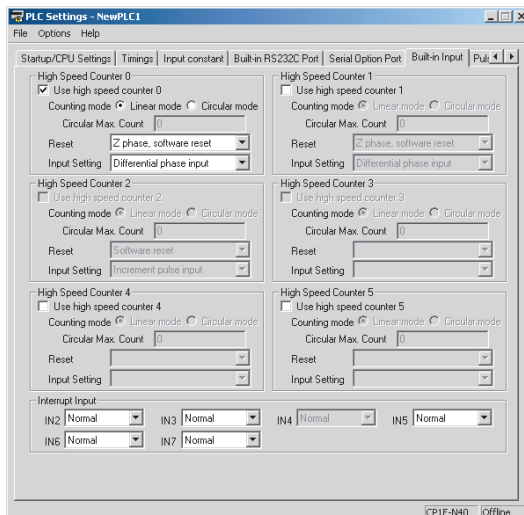

- 3** Select the *Use high speed counter 0* Check Box for high-speed counter 0.
- 4** Select *Linear Mode* for the counting mode.
- 5** Select *Software reset (comparing)* for the reset method.
- 6** Select *Differential phase input* for the input setting.
- 7** Close the PLC Settings Dialog Box.
- 8** Restart the PLC.  
The changes made to the PLC Setup is applied.

● **Programming Example 1**

In this example, the CTBL (COMPARISON TABLE LOAD) instruction is used to create an interrupt when the target value is reached. Slowing and stopping are executed as interrupt tasks, allowing high-speed processes to be executed without affecting the cycle time.

**Ladder Program**

Use the CTBL instruction to execute interrupt tasks when the target positions are reached.

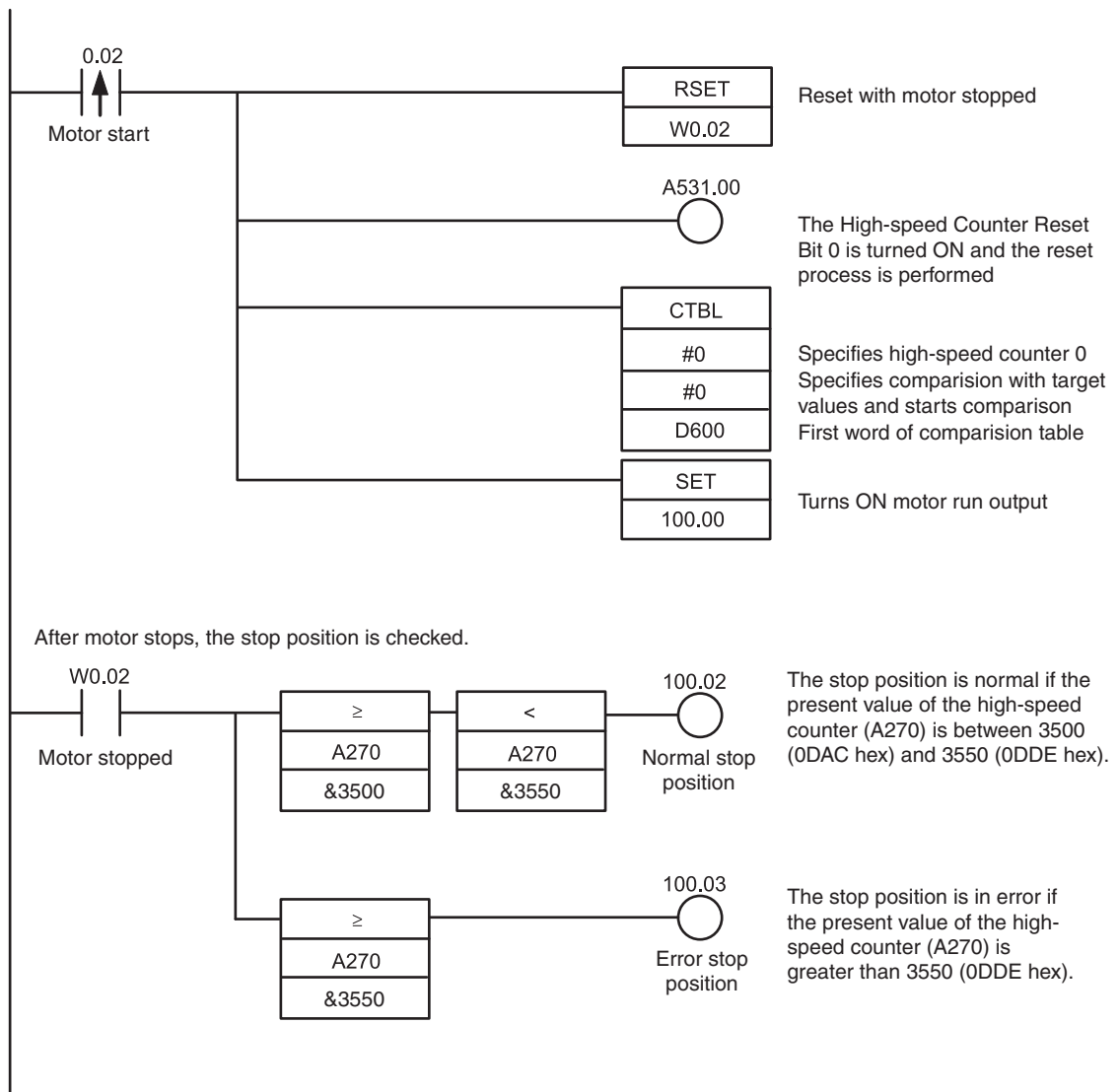

When the PV of the high-speed counter matches target value 1 (3000), interrupt task 4 is executed.

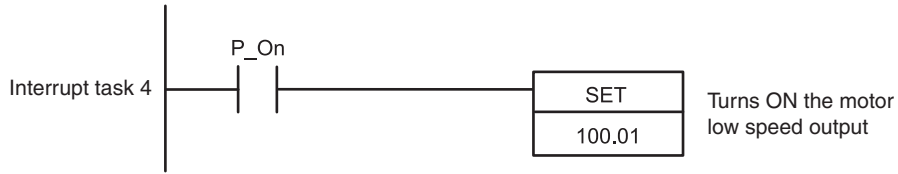

When the present vale of the high-speed counter matches target value 2 (3500), interrupt task 5 is executed.

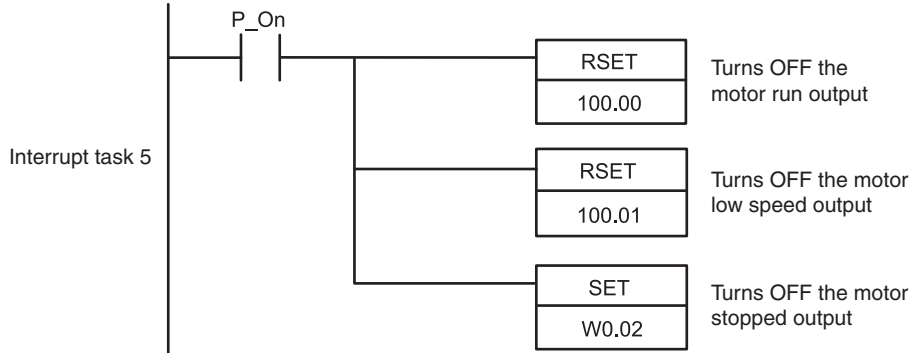

### DM Area Setup

The comparison table for the CTBL (COMPARISON TABLE LOAD) instruction is set in D600 through D606.

Word	Value	Contents
D600	0002	Number of target values: 2
D601	0BB8	Target value 1: 3000 (BB8 hex)
D602	0000	
D603	0004	Target value 1: Interrupt task No.4
D604	0DAC	Target value 2: 3500 (DAC hex)
D605	0000	Target value 2: Interrupt task No.5
D606	0005	

# Pulse Outputs

This section describes positioning functions such as trapezoidal control, jogging, and origin searches.

<b>12-1 Overview</b> .....	<b>12-2</b>
12-1-1 Overview .....	12-2
12-1-2 Flow of Operation .....	12-4
12-1-3 Specifications .....	12-12
<b>12-2 Positioning Control</b> .....	<b>12-13</b>
12-2-1 Positioning Control Configuration .....	12-13
12-2-2 Relative Positioning and Absolute Positioning .....	12-13
12-2-3 Application Example .....	12-15
<b>12-3 Jogging</b> .....	<b>12-17</b>
12-3-1 High-speed Jogging .....	12-17
12-3-2 Low-speed Jogging .....	12-17
12-3-3 Application Example .....	12-17
<b>12-4 Defining Origin Position</b> .....	<b>12-20</b>
12-4-1 Origin Searches .....	12-20
12-4-2 Flow of Operation .....	12-21
12-4-3 Settings in PLC Setup .....	12-21
12-4-4 Origin Search Instructions .....	12-24
12-4-5 Origin Search Operations .....	12-25
12-4-6 Origin Return .....	12-32
12-4-7 Changing the Present Value of the Pulse Output .....	12-33
<b>12-5 Reading the Pulse Output Present Value</b> .....	<b>12-34</b>
<b>12-6 Related Auxiliary Area Flags</b> .....	<b>12-35</b>
<b>12-7 Application Examples</b> .....	<b>12-36</b>
12-7-1 Vertically Conveying PCBs (Multiple Progressive Positioning) .....	12-36
12-7-2 Feeding Wrapping Material: Interrupt Feeding .....	12-41
<b>12-8 Precautions when Using Pulse Outputs</b> .....	<b>12-44</b>
<b>12-9 Pulse Output Pattern</b> .....	<b>12-49</b>
12-9-1 Speed Control (Continuous Mode) .....	12-49
12-9-2 Positioning Control (Independent Mode) .....	12-51

# 12-1 Overview

Pulse outputs can be used only with the CP1E N/NA□□(S)-type CPU Unit with transistor outputs.

## 12-1-1 Overview

Pulse outputs can be output from the CPU Unit's built-in outputs using instructions to perform positioning or speed control with a servomotor or a stepping motor that accepts pulse inputs. It is also possible to perform origin searches or origin returns.

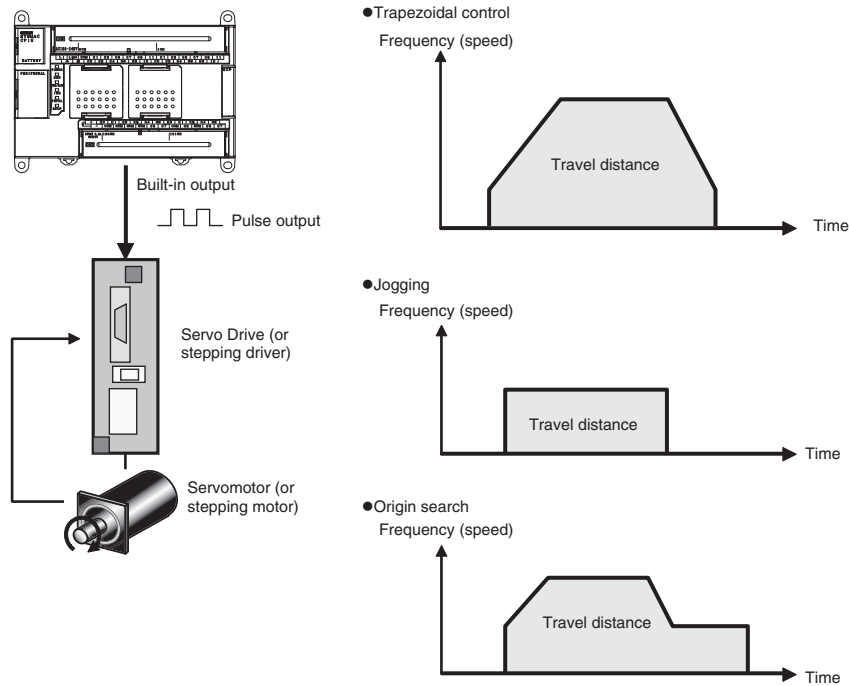

Positioning is performed with a servomotor or stepping motor in the following configuration.

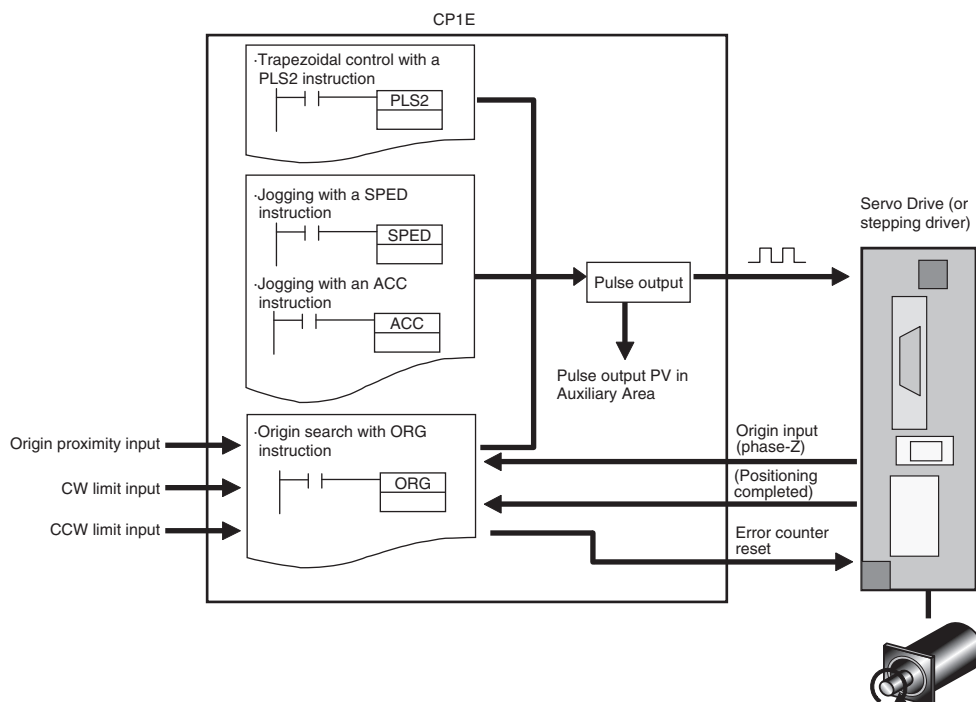

## Wiring for N□□S(1)-type CPU Unit

An external power supply is required for N□□S(1)-type CPU Units when using the PWM output. Provide a DC24V external power supply to V+ and V- terminals as follows.

### Wiring Example

Sinking outputs

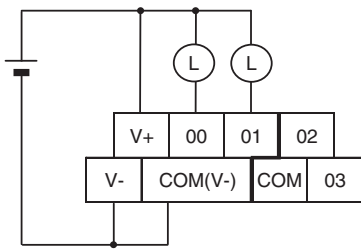

Although V- and COM(V-) are connected internally, also wire them externally.

Sourcing outputs

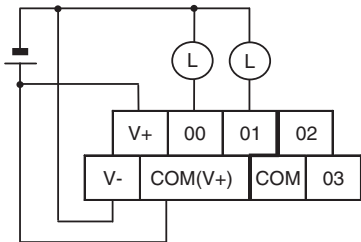

Although V+ and COM(V+) are connected internally, also wire them externally.

Do not connect an external power supply to N□□-type CPU Units.

## 12-1-2 Flow of Operation

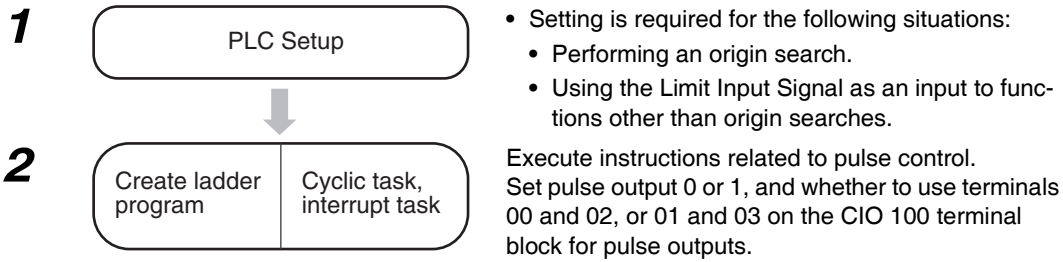

## PLC Setup

To perform an origin search or to use a Limit Input Signal as an input to a function other than origin search, set the parameters on the Pulse Output 0 and Pulse Output 1 Tab Pages in the PLC Setup.

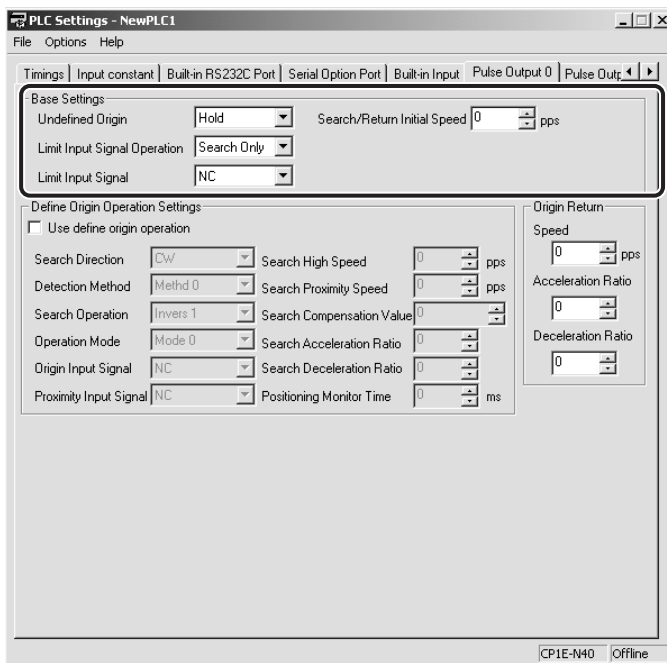

Pulse Output 0 or 1 Tab Page

	Item	Setting	Description
Base Settings	Undefined Origin	Hold	When a Limit Input Signal is input, the pulse output is stopped and the previous status is held.
		Undefined	When a Limit Input Signal is input, the pulse output is stopped and origin becomes undefined.
	Limit Input Signal Operation	Search Only	The CW/CCW Limit Input Signal is used for origin searches only.
		Always	The CW/CCW Limit Input Signal is used by functions other than origin search.
	Limit Input Signal	NC	Select when using NC contacts for the Limit Input Signal.
		NO	Select when using NO contacts for the Limit Input Signal.
	Search/Return Initial Speed	Set the motor's starting speed when performing an origin search. Specified in pulses per second (pps).	

**Note** The power supply must be restarted after the PLC Setup is transferred in order to enable the pulse output settings.

Refer to *12-4 Defining Origin Position* for origin search settings in the PLC Setup.



## Setting the Pulse Output Port Number, Assigning Pulse Output Terminals, and Wiring

### ● Pulse Output Method

Only the following pulse output plus a direction output can be used as the pulse output method.

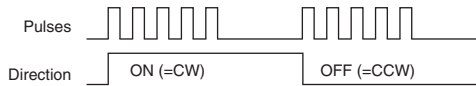

### ● Pulse Output Port Number and Output Terminals

The following terminals are used for pulse outputs according to the pulse output port number.

Output terminal block		Pulse output method	Other functions that cannot be used at the same time	
Terminal block label	Terminal number	Pulse plus direction	Normal output	PWM output
CIO 100	00	Pulse output 0, pulse	Normal output 0	–
	01	Pulse output 1, pulse	Normal output 1	PWM output
	02	Pulse output 0, direction	Normal output 2	–
	03	Pulse output 1, direction	Normal output 3	–

### Origin Searches

Use the following input and output terminals for origin searches.

#### Input Terminals

- N20/30/40/60(S□) or NA20 CPU Units

Input terminal block		Setting in PLC Setup	Other functions that cannot be used at the same time			
Terminal block label	Terminal number	Enable origin searches for pulse outputs 0 and 1	Normal inputs	Interrupt inputs	Quick-response inputs	High-speed counter setting Increment pulse input
CIO 0	06	Pulse 0, Origin input signal	Normal input 6	Interrupt input 6	Quick-response input 6	High-speed counter 5
	07	Pulse 1, Origin input signal	Normal input 7	Interrupt input 7	Quick-response input 7	–
	:	:				
	10	Pulse 0, Origin proximity input signal	Normal input 10	–	–	–
	11	Pulse 1, Origin proximity input signal	Normal input 11	–	–	–

- N14 CPU Units

Input terminal block		Setting in PLC Setup	Other functions that cannot be used at the same time			
Terminal block label	Terminal number	Enable origin searches for pulse outputs 0 and 1	Normal inputs	Interrupt inputs	Quick-response inputs	High-speed counter setting
						Increment pulse input
CIO 0	03	Pulse 0, Origin proximity input signal	Normal input 3	Interrupt input 3	Quick-response input 3	–
	:	:				
	05	Pulse 1, Origin proximity input signal	Normal input 5	Interrupt input 5	Quick-response input 5	High-speed counter 4
	06	Pulse 0, Origin input signal	Normal input 6	Interrupt input 6	Quick-response input 6	High-speed counter 5
	07	Pulse 1, Origin input signal	Normal input 7	Interrupt input 7	Quick-response input 7	–

### Output Terminals

Output terminal block		Setting in PLC Setup	Other functions that cannot be used at the same time
Terminal block label	Terminal number	Enable origin searches for pulse outputs 0 and 1	Normal outputs
CIO 100	04	Pulse 0, Error counter reset output	Normal output 4
	05	Pulse 1, Error counter reset output	Normal output 5

**Note** When the origin search is in operating mode 0, normal output 4 and 5 can be used at the same time.

## Connecting the Servo Drive and External Sensors

### ● Connections for Pulse Output 0

Terminal block		Addresses	Signal	Origin search			
Terminal block label	Terminal number			Operating mode 0	Operating mode 1	Operating mode 2	
CIO 100	00	CIO 100.00	Stored in A276 and A277.	Pulse	Connect to Servo Drive's pulse input (PULS).		
	02	CIO 100.02		Direction	Connect to Servo Drive's direction input (SIGN).		
Normal input		The external signal must be received as an input and the input status must be written to A540.08 in the ladder program.	CW limit sensor	Connect sensor to a normal input terminal.			
Normal input		The external signal must be received as an input and the input status must be written to A540.09 in the ladder program.	CCW limit sensor	Connect sensor to a normal input terminal.			
CIO 0	03	CIO 0.03	Origin proximity input	Connect to sensor for N14 CPU Unit.			
	06	CIO 0.06	Origin input	Connect to open-collector output from sensor or other device.	Connect to the phase-Z signal from the Servo Drive.	Connect to the phase-Z signal from the Servo Drive.	
	10	CIO 0.10	Origin proximity input	Connect to sensor for N20/30/40/60 or NA20 CPU Unit.			
CIO 100	04	CIO 100.04	Error counter reset output	Not used.	Connect to error counter reset (ECRST) of the Servo Drive.		
Normal input		The external signal must be received as an input and the input status must be written to A540.10 in the ladder program.	Positioning completed input		Not used.	Connect the Positioning Completed Signal (INP) from the Servo Drive to a normal input terminal.	

## ● Connections for Pulse Output 1

Terminal block		Addresses	Signal	Origin search			
Terminal block label	Terminal number			Operating mode 0	Operating mode 1	Operating mode 2	
CIO 100	01	CIO 100.01	Stored in A278 and A279	Pulse	Connect to Servo Drive's pulse input (PULS).		
	03	CIO 100.03		Direction	Connect to Servo Drive's direction input (SIGN).		
Normal input		The external signal must be received as an input and the input status must be written to A541.08 in the ladder program.		CW limit sensor	Connect sensor to a normal input terminal.		
Normal input		The external signal must be received as an input and the input status must be written to A541.09 in the ladder program.		CCW limit sensor	Connect sensor to a normal input terminal.		
CIO 0	05	CIO 0.05		Origin proximity input	Connect to sensor for N14 CPU Unit.		
	07	CIO 0.07		Origin input	Connect to open-collector output from sensor or other device.	Connect to the phase-Z signal from the Servo Drive.	Connect to the phase-Z signal from the Servo Drive.
	11	CIO 0.11		Origin proximity input	Connect to sensor for N20/30/40/60 or NA20 CPU Unit.		
CIO 100	05	CIO 100.05		Error counter reset output	Not used.	Connect to error counter reset (ECRST) of the Servo Drive.	
Normal input		The external signal must be received as an input and the input status must be written to A541.10 in the ladder program.		Positioning completed input	Not used.	Connect the Positioning Completed Signal (INP) from the Servo Drive to a normal input terminal.	

● Pulse Output Wiring

N□□-type

Example: Sinking outputs

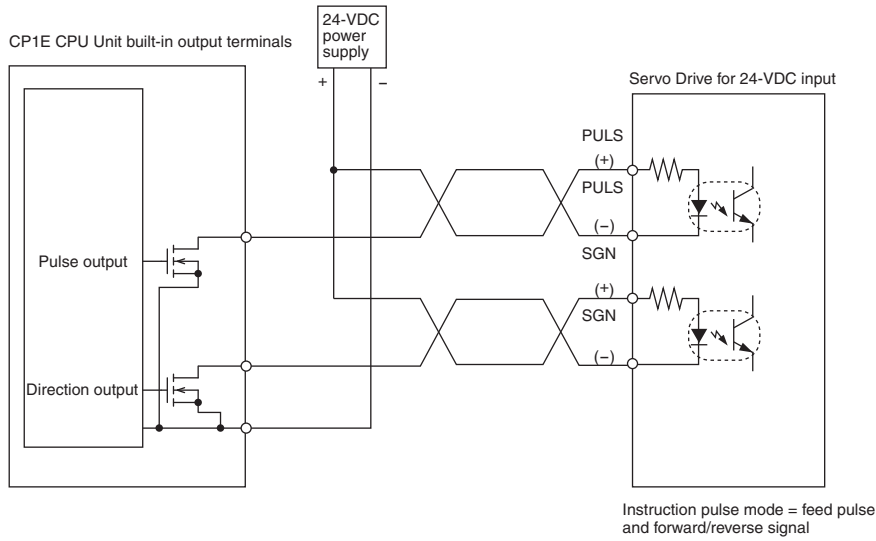

N□□S(1)-type (Example: Sinking outputs)

It is necessary to wire an external power supply to N□□S(1)-type CPU Units. Connect a DC24V external power supply between V+ and V- in order to use terminals 00 and 01 on terminal block CIO 100.

**Note** COM corresponding to CIO 100.00 and CIO 100.01 has been internally connected with V- for sinking output models, with V+ for sourcing output models.

Example: Sinking outputs

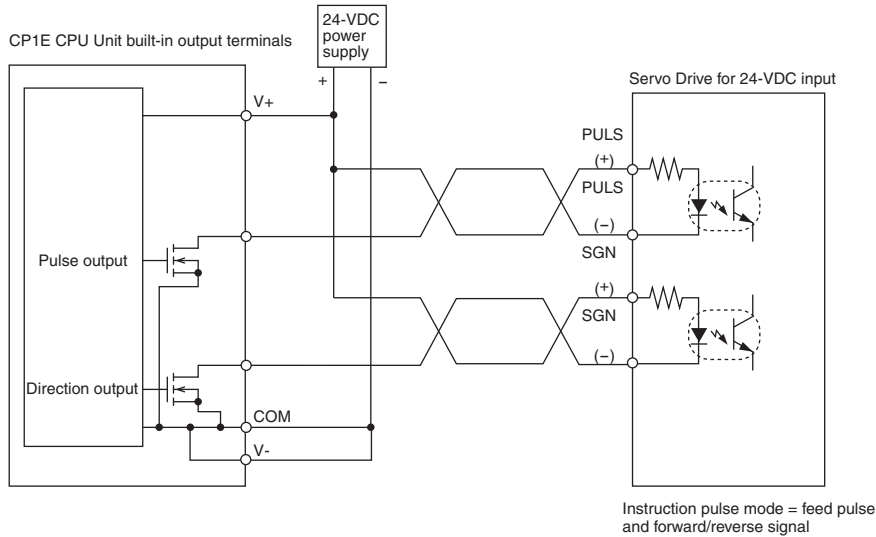

## Connecting to OMRON Servo Drives

Use the following cables to connect to an OMRON Servo Drive.

OMRON Servo Drive	Cable mode: □ Indicates the cable length (1m or 2m)
SmartStep2 Series (pulse string input)	R7A-CPB□□□S
SmartStep Junior (pulse string input)	R7A-CPZ□□□S
W Series (pulse string input)	R88A-CPW□□□S
G Series (pulse string input)	R88A-CPG□□□S

Set the Servo Drive's command pulse mode to feed pulse and forward/reverse signals because the method of pulse output from a CP1E CPU Unit is pulse + direction.

### ● Connecting to a SmartStep2-series Servo Drive

Operating Mode 1

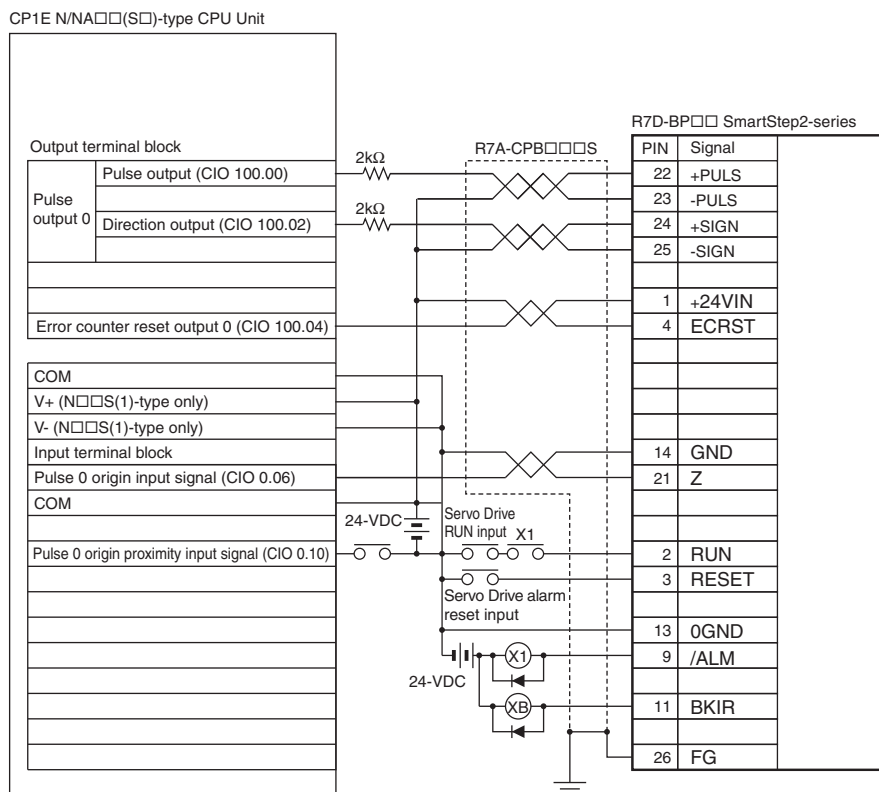

Only N□□S(1)-type CPU Units can wire V+ and V-. Do not wire them in N□□-type CPU Units.

**R7A-CPB□□□S Cables for SmartStep2-series Servo Drives**

No.	Wire color (mark color)	Symbol
1	Orange (Red 1)	+24VIN
2	Orange (Black 1)	RUN
3	Gray (Red 1)	RESET
4	Gray (Black 1)	ECRST/VSEL2
5	White (Red 1)	GSEL/VZERO/TLSEL
6	White (Black 1)	GESEL/VSEL1
7	Yellow (Red 1)	NOT
8	Yellow (Black 1)	POT
9	Pink (Red 1)	/ALM
10	Pink (Black 1)	INP/TGON
11	Orange (Red 2)	BKIR
12	Orange (Black 2)	WARN
13	Gray (Red 2)	OGND
14	Gray (Black 2)	GND
15	White (Red 2)	+A
16	White (Black 2)	-A
17	Yellow (Black 2)	+B
18	Yellow (Red 2)	-B
19	Pink (Red 2)	+Z
20	Pink (Black 2)	-Z
21	Orange (Red 3)	Z
22	Gray (Red 3)	+CW/+PULS/+FA
23	Gray (Black 3)	-CW/-PULS/-FA
24	White (Red 3)	+CCW/+SIGN/+FB
25	White (Black 3)	-CCW/-SIGN/-FB
26	Orange (Black 3)	FG

10126-3000PE Connector Plug (3M)

10326-52AD-008 Connector Plug (3M)

AWG24 × 13P UL20276 Cable

Each twisted pair has wires of the same color and number of marks.

**R7A-CPZ□□□S Cables for SmartStep Junior Servo Drives**

No.	Wire / mark colors	Symbol
1	Orange/Red (-)	+CW/PULS
2	Orange/Black (-)	-CW/PULS
3	Light gray/Red (-)	+CCW/SIGN
4	Light gray/Black (-)	-CCW/SIGN
5	White/Red (-)	+24VIN
6	Yellow/Black (-)	RUN
7	White/Black (-)	OGND
8	Pink/Red (-)	+ECRST
9	Pink/Black (-)	-ECRST
10	Orange/Red (--)	Z
11	Orange/Black (--)	ZCOM
12	Light gray/Red (--)	/ALM
13	Light gray/Black (--)	BKIR
14	Yellow/Red (-)	INP

## Executing Pulse Control Instructions in a Ladder Program

The pulse outputs are used by executing pulse control instructions in the ladder program.

### ● Applicable Instructions

The following instructions are used.

Purpose		Overview	Instruction	Reference
Performing trapezoidal control		Performs trapezoidal pulse output control with independent acceleration and deceleration rates. (The number of pulses can be set.)	PLS2: PULSE OUTPUT	Refer to 12-2
Jogging	Without acceleration and deceleration	Performs pulse output control without acceleration or deceleration.	SPED: SPEED OUTPUT	Refer to 12-3
	With acceleration and deceleration	Performs trapezoidal pulse output control with the same acceleration and deceleration rates.	ACC: ACCELERATION CONTROL	
Performing origin searches		Actually moves the motor with pulse outputs and defines the machine origin based on the Origin Proximity Input and Origin Input signals.	ORG: ORIGIN SEARCH	Refer to 12-4-4
Performing origin returns		Returns to the origin position from any position.	ORG: ORIGIN SEARCH	Refer to 12-4-6
Changing or reading the pulse output PV		Changes the PV of the pulse output. (This operation defines the origin location.)	INI: MODE CONTROL	Refer to 12-4-7
		Reads the PV of the pulse output.	PRV: HIGH-SPEED COUNTER PV READ	Refer to 12-5

### ● Outputting to the Auxiliary Area Using the OUT Instruction

The OUT instruction in the ladder program is used to write signals received from the CW limit sensor and CCW limit sensor connected to normal inputs to the Auxiliary Area bits.

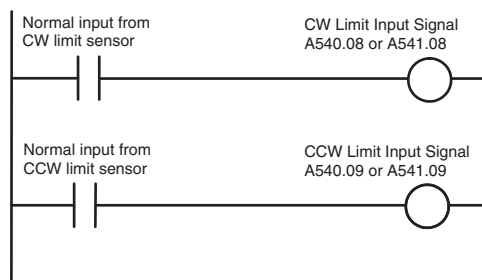

### Bits Written in the Auxiliary Area

Auxiliary Area		Name	
Word	Bit		
A540	08	Pulse Output 0 CW Limit Input Signal	Signals must be received from external sensors connected to normal inputs and then written to the Auxiliary Area by the user program.
	09	Pulse Output 0 CCW Limit Input Signal	
A541	08	Pulse Output 1 CW Limit Input Signal	
	09	Pulse Output 1 CCW Limit Input Signal	

### 12-1-3 Specifications

Item	Specifications
Output mode	Continuous mode (for speed control) or independent mode (for position control)
Positioning (independent mode) instructions	PULS and SPED, PULS and ACC, or PLS2
Speed control (continuous mode) instructions	SPED or ACC
Origin (origin search and origin return) instructions	ORG
Output frequency	1 Hz to 100 kHz (1 Hz units), two pulse outputs
Frequency acceleration and deceleration rates	Set in increments of 1 Hz for acceleration/deceleration rates from 1 to 65,535 Hz (every 4 ms). The acceleration and deceleration rates can be set independently only with the PLS2 instruction.
Changing SVs during instruction execution	The target frequency, acceleration/deceleration rate, and target position can be changed.
Duty factor	Fixed at 50%
Pulse output method	Pulse + direction outputs (CW/CCW outputs cannot be used.)
Number of output pulses	Relative coordinates: 0000 0000 to 7FFF FFFF hex(Accelerating or decelerating in either direction: 2,147,483,647) Absolute coordinates: 8000 0000 to 7FFF FFFF hex(-2,147,483,648 to 2,147,483,647)
Pulse output PV's relative/absolute coordinate specifications	Absolute coordinates are specified automatically when the origin location has been defined by setting the pulse output PV with the INI instruction or performing an origin search with the ORG instruction. Relative coordinates are used when the origin location is undefined.
Relative pulse/absolute pulse specifications	The pulse type can be specified with an operand in the PULS or PLS2 instruction.  <b>Note</b> The absolute pulse specification can be used when absolute coordinates are specified for the pulse output PV, i.e. the origin location has been defined. The absolute pulse specification cannot be used when relative coordinates are specified, i.e. the origin location is undefined. An instruction error will occur.
Pulse output PV's storage location	The following Auxiliary Area words contain the pulse output PVs Pulse output 0: A277 (leftmost 4 digits) and A276 (rightmost 4 digits) Pulse output 1: A279 (leftmost 4 digits) and A278 (rightmost 4 digits) The PVs are refreshed during regular I/O refreshing.



## 12-2 Positioning Control

This section describes how to use pulse outputs with trapezoidal acceleration and deceleration when using the PLS2 instruction.

### 12-2-1 Positioning Control Configuration

If the target frequency, starting frequency, acceleration and deceleration rate, direction are set beforehand, the following time chart will perform trapezoidal positioning control.

Specify the output waveform in the instruction operands.

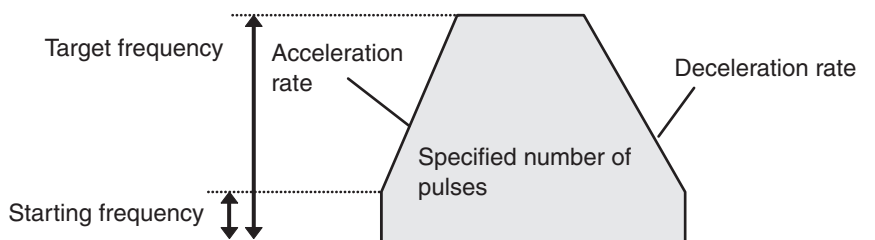

Target frequency	1 Hz to 100 kHz (in increments of 1 Hz)
Starting frequency	0 Hz to 100 kHz (in increments of 1 Hz)
Acceleration rate	Set in increments of 1 Hz from 1 to 65,535 Hz (every 4 ms).
Deceleration rate	Set in increments of 1 Hz from 1 to 65,535 Hz (every 4 ms).
Direction specification	Set to CW or CCW.
Specified number of pulses	Relative coordinates: 0000 0000 to 7FFF FFFF hex (Incrementing and decrementing in each direction: 2,147,483,647) Absolute coordinates: 8000 0000 to 7FFF FFFF hex (-2,147,483,648 to 2,147,483,647)

### 12-2-2 Relative Positioning and Absolute Positioning

#### ● Selecting Relative or Absolute Coordinates

The pulse output PV's coordinate system (absolute or relative) is selected automatically, as follows:

- When the origin is undefined, the system operates in relative coordinates.
- When the origin has been defined, the system operates in absolute coordinates.

Conditions	Origin has been defined by an origin search	Origin has been defined by executing the INI instruction to change the PV	Origin undefined (Origin search has not been performed and PV has not been changed with the INI instruction.)
Pulse output PV's coordinate system	Absolute coordinates		Relative coordinates

Refer to *12-4-1 Origin Searches* for details.

● Relationship between the Coordinate System and Pulse Specification

The following table shows the pulse output operation for the four possible combinations of the coordinate systems (absolute or relative) and the pulse output (absolute or relative) specified when the PULS or PLS2 instruction is executed.

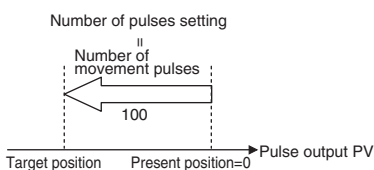
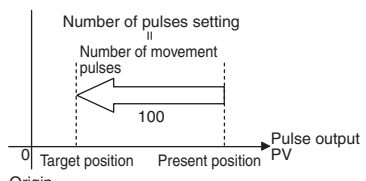
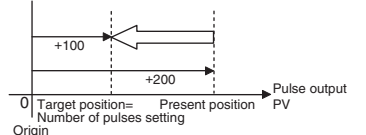
Pulse output specified in PULS or PLS2	Relative coordinate system	Absolute coordinate system
	Origin undefined: The No-origin Flag will be ON.	Origin defined: The No-origin Flag will be OFF.
Relative pulse specification	<p>Positions the system to another position relative to the present position. Number of movement pulses = Number of pulses setting</p> <p>The pulse output PV after instruction execution = Number of movement pulses = Number of pulses setting The pulse output PV is reset to 0 just before pulses are output. After that, the specified number of pulses is output. The following example shows the number of pulses setting = 100 counterclockwise.</p>  <p>Pulse output PV range: 8000 0000 to 7FFF FFFF hex Number of pulses setting range: 0000 0000 to 7FFF FFFF hex</p>	<p>Positions the system to another position relative to the present position. Number of movement pulses = Number of pulses setting</p> <p>The pulse output PV after instruction execution = PV + Number of movement pulses. The following example shows the number of pulses setting = 100 counterclockwise.</p>  <p>Pulse output PV range: 8000 0000 to 7FFF FFFF hex Number of pulses setting range: 0000 0000 to 7FFF FFFF hex</p>
Absolute pulse specification	<p>The absolute pulse specification cannot be used when the origin location is undefined, i.e., when the system is operating in the relative coordinate system. An instruction execution error will occur.</p>	<p>Positions the system to an absolute position relative to the origin. The number of movement pulses and movement direction are calculated automatically from the present position (pulse output PV) and target position. The following example shows the number of pulses setting = +100.</p>  <p>Number of movement pulses = Number of pulses setting – Pulse output PV when instruction is executed. The movement direction is determined automatically. Pulse output PV when instruction is executed = Number of pulses setting Pulse output PV range: 8000 0000 to 7FFF FFFF hex Number of pulses setting range: 8000 0000 to 7FFF FFFF hex</p>



### Precautions for Correct Use

The absolute pulse cannot be specified with the origin undefined. Please specify them when the origin is defined by performing the origin searches.



### Additional Information

The origin position is undefined in the following case. Please define the origin position by performing the origin searches again.

- When the pulse output reset flag is turned ON
- When the RUN or MONITOR mode is changed to the PROGRAM mode

## 12-2-3 Application Example

### Specifications and Operation

When the start input (CIO 0.00) goes ON, this example program outputs 600,000 pulses from pulse output 1 to turn the motor.

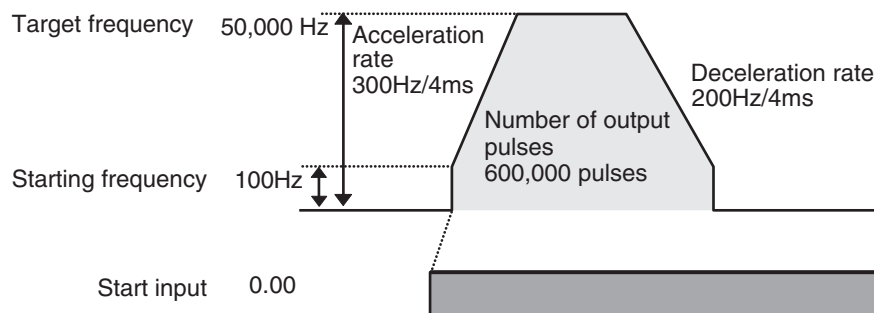

### Applicable Instructions

PLS2

### Preparations

#### ● PLC Setup

There are no settings that need to be made in the PLC Setup.

## ● DM Area Settings

- Settings for PLS2 Instruction (D0 to D7)

Setting	Address	Data
Acceleration rate: 300 Hz/4 ms	D0	#012C
Deceleration rate: 200 Hz/4 ms	D1	#00C8
Target frequency: 50,000 Hz	D2	#C350
	D3	#0000
Number of output pulses: 600,000 pulses	D4	#27C0
	D5	#0009
Starting frequency: 100 Hz	D6	#0064
	D7	#0000

## Ladder Program

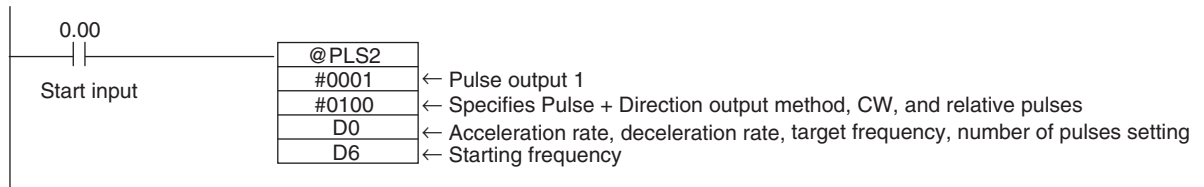

### Additional Information

- Absolute pulses can be specified when the origin position has been defined.
- If a target frequency that cannot be reached has been set, the target frequency will be reduced automatically, i.e., triangular control will be performed. In some cases where the acceleration rate is substantially greater than the deceleration rate, the operation will not be true triangular control. The motor will be operated at a constant speed for a short time between the acceleration and deceleration.

## 12-3 Jogging

Jogging can be performed by using the SPED (SPEED OUTPUT) and ACC (ACCELERATION CONTROL) instructions. This section describes the steps for jogging.

### 12-3-1 High-speed Jogging

Start pulse output with acceleration or deceleration using the ACC instruction. In this case, acceleration and deceleration rate must be the same. Set the target frequency of the ACC instruction to 0 Hz to stop the pulse output.

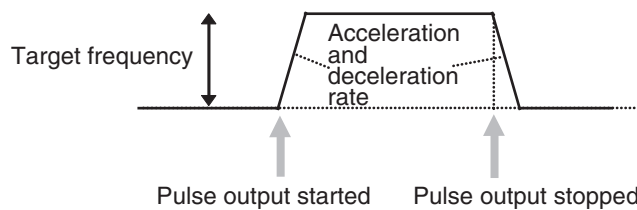

Target frequency	Starting pulse output: 1 Hz to 100 kHz (in increments of 1 Hz) Stopping pulse output: 0 Hz
Acceleration and deceleration rate	Set in increments of 1 Hz from 1 to 65,535 Hz (every 4 ms).
Direction specification	Set to CW or CCW.
Mode specification	Set to continuous mode.

### 12-3-2 Low-speed Jogging

Start pulse output without acceleration or deceleration using the SPED instruction. Set the target frequency of the SPED instruction to 0 Hz to stop the pulse output.

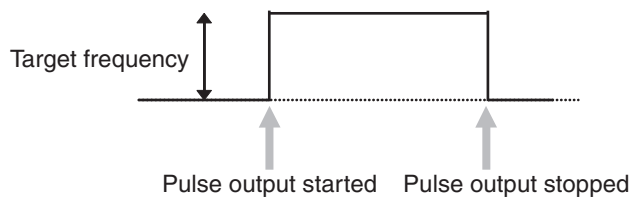

Target frequency	Starting pulse output: 1 Hz to 100 kHz (in increments of 1 Hz) Stopping pulse output: 0 Hz
Direction specification	Set to CW or CCW.
Mode specification	Set to continuous mode.

### 12-3-3 Application Example

#### Specifications and Operation

The following example shows jogging without acceleration or deceleration executed using a SPED instruction. It is used for low-speed jogging.

- Clockwise low-speed jogging will be executed from pulse output 1 while CIO 0.00 is ON.
- Counterclockwise low-speed jogging will be executed from pulse output 1 while CIO 0.01 is ON.

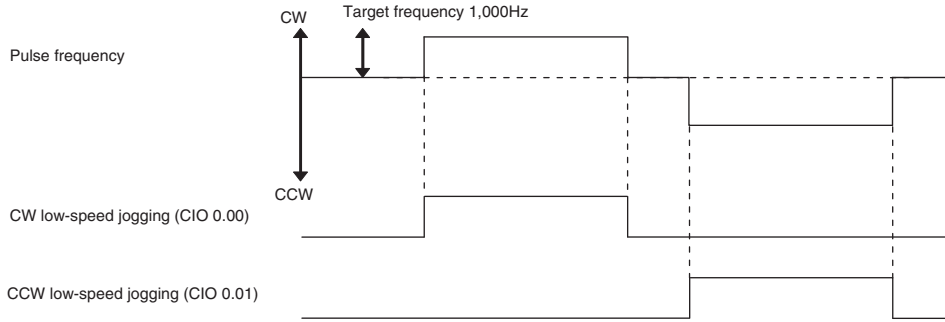

The example shows jogging with acceleration and deceleration executed using an ACC instruction. It is used for high-speed jogging.

- Clockwise high-speed jogging will be executed from pulse output 1 while CIO 0.04 is ON.
- Counterclockwise high-speed jogging will be executed from pulse output 1 while CIO 0.05 is ON.

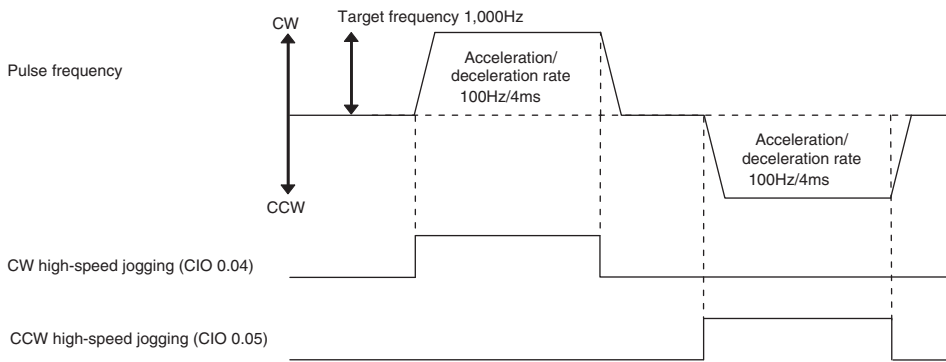

## Preparations

### ● PLC Setup

There are no settings that need to be made in the PLC Setup.

### ● DM Area Settings

- Settings to Control Speed while Jogging (D0 to D1 and D10 to D15)

Setting	Address	Data
Target frequency (low speed): 1,000 Hz	D0	#03E8
	D1	#0000
Acceleration rate: 100 Hz/4 ms	D10	#0064
Target frequency (high speed): 100,000 Hz	D11	#86A0
	D12	#0001
Acceleration/deceleration rate: 100 Hz/4 ms (Not used.)	D13	#0064
Target frequency (stop): 0 Hz	D14	#0000
	D15	#0000

## Ladder Program

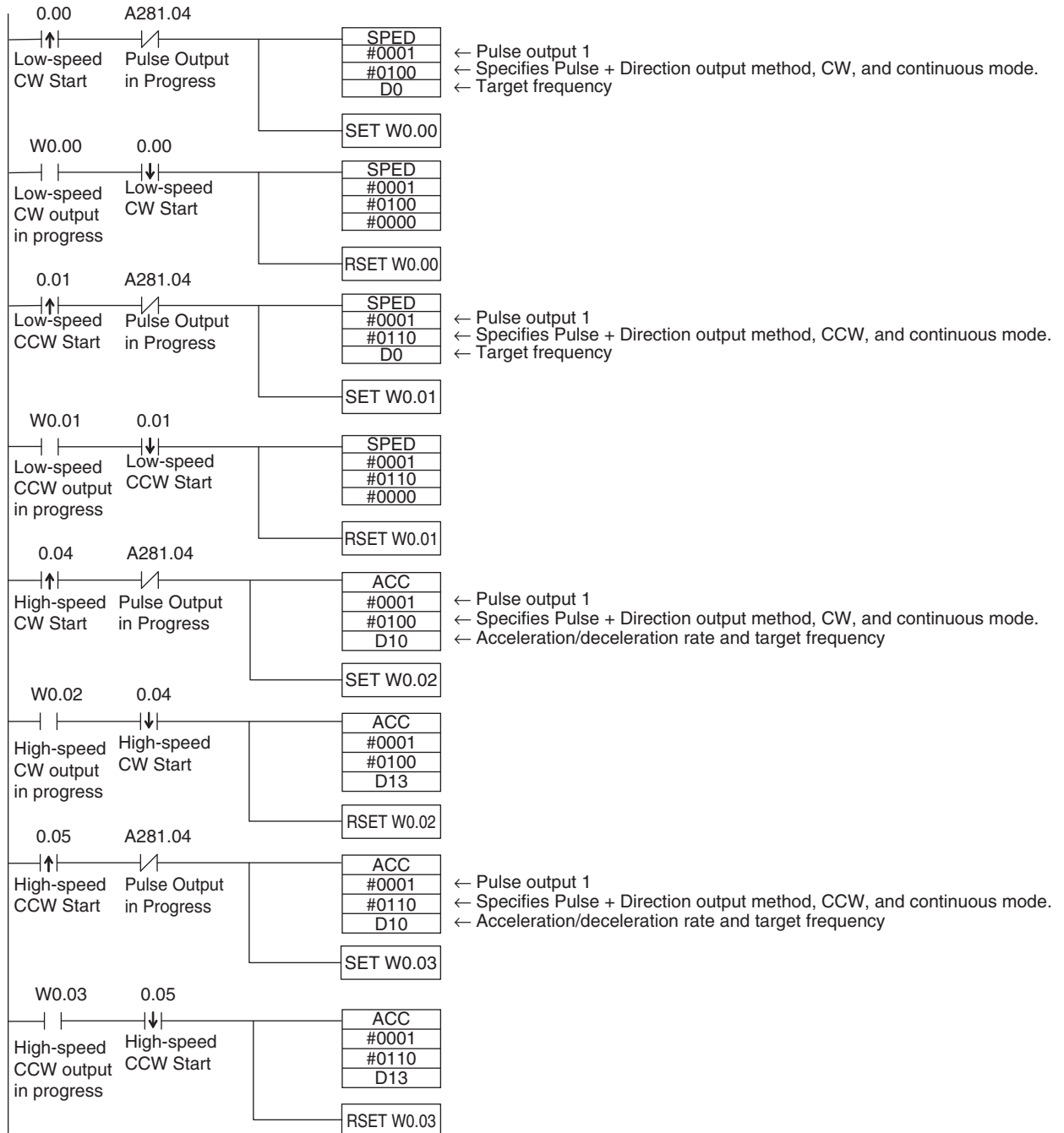

### Additional Information

The PLS2 instruction can be used to set a starting frequency or separate acceleration and deceleration rates, but there are limitations on the operating range because the end point must be specified in the PLS2 instruction.

## 12-4 Defining Origin Position

The CP1E CPU Units have two methods that can be used to define the origin position.

- Origin Search

The ORG instruction outputs pulses to turn the motor according to the pattern specified in the origin search parameters. As the motor turns, the origin search function defines the origin from the following three kinds of position input signals.

- Origin input signal
- Origin proximity input signal
- CW limit input signal and CCW limit input signal

- Changing the Pulse Output PV

When setting the current position as the origin, execute INI to reset the pulse output PV to 0.

### 12-4-1 Origin Searches

When the ORG instruction executes an origin search, it outputs pulses to actually move the motor and defines the origin position using the input signals that indicate the origin proximity and origin positions.

The input signals that indicate the origin position can be received from the servomotor's built-in phase-Z signal or external sensors such as photoelectric sensors, proximity sensors, or limit switches.

In the following example, the motor is started at a specified speed, accelerated to the origin search high speed, and run at that speed until the origin proximity position is detected. After the Origin Proximity Input is detected, the motor is decelerated to the origin search low speed and run at that speed until the origin position is detected. The motor is stopped at the origin position.

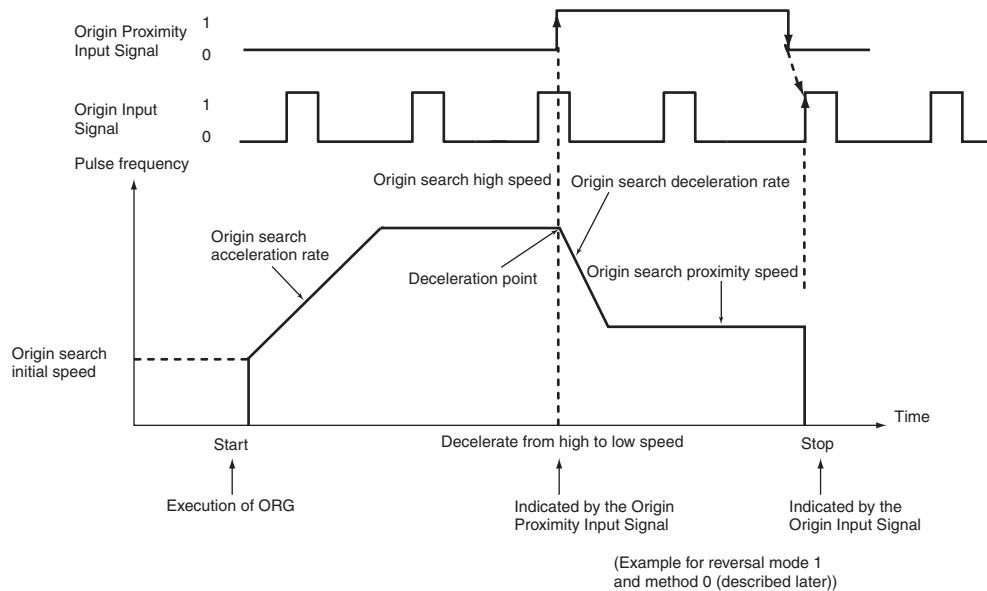



#### Additional Information

The motor can be moved even if the origin position has not been defined, but positioning operations will be limited as follows:

- Origin return: Cannot be used.
- Positioning with absolute pulse specification: Cannot be used.
- Positioning with relative pulse specification: Outputs the specified number of pulses after setting the present position to 0.

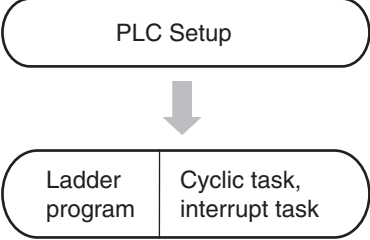

## 12-4-2 Flow of Operation

- 1 
  - Set the origin search parameters in the Pulse Output 0 and Pulse Output 1 Tab Pages of the PLC Setup using the CX-Programmer.
- 2 
  - Set output pulse 0 or 1, and whether to use terminals 00 and 01, or 02 and 03 on the CIO100 terminal block for pulse outputs.
  - Output the status of the Limit Signal Inputs and Positioning Completed Signal to Auxiliary Area bits.
  - Execute ORG. Specify an origin search.

## 12-4-3 Settings in PLC Setup

To perform an origin search or to use a Limit Input Signal as an input to a function other than origin search, set the parameters on the Pulse Output 0 and Pulse Output 1 Tab Pages in the PLC Setup.

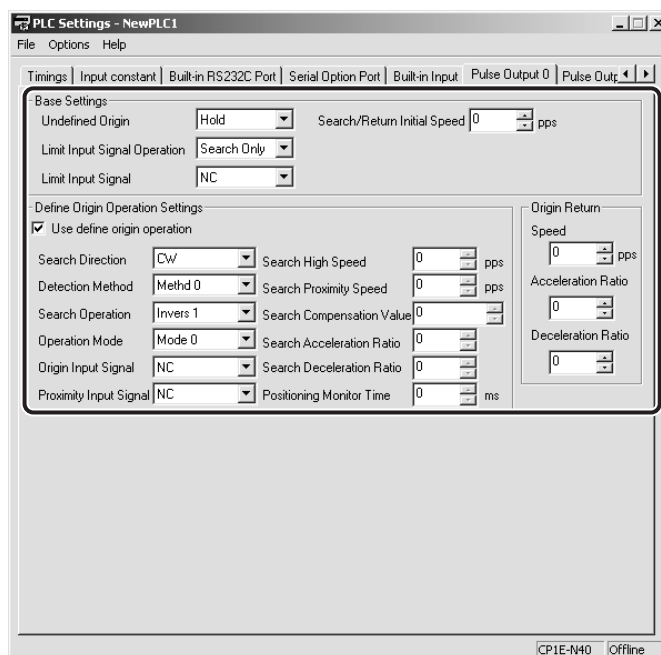

Pulse Output 0 or 1 Tab Page

Item	Selection	Description	
<b>Base Settings</b>	<b>Undefined Origin</b>	Hold	When a Limit Input Signal is input, the pulse output is stopped and the previous status is held.
		Undefined	When a Limit Input Signal is input, the pulse output is stopped and origin becomes undefined.
	<b>Limit Input Signal Operation</b>	Search Only	The CW/CCW Limit Input Signal is used for origin searches only.
		Always	The CW/CCW Limit Input Signal is used by functions other than origin search.
	<b>Limit Input Signal</b>	NC	Select when using NC contacts for the Limit Input Signal.
		NO	Select when using NO contacts for the Limit Input Signal.
<b>Search/Return Initial Speed</b>		Set the motor's starting speed when performing an origin search or origin return. Specified in units of pulses per second (pps). Setting range: 0 to 100k pps The origin search will not be performed in these cases: Origin search high speed ≤ Origin search proximity speed. Origin search proximity speed ≤ Origin search initial speed.	
<b>Define Origin Operation Settings</b>	<b>Use define origin operation</b>	Select this check box to use origin searches.	
	<b>Search Direction</b>		Set the direction for detecting the Origin Input Signal. An origin search is performed so that the Origin Input Signal's rising edge is detected when moving in the origin search direction.
		CW	Performs origin search in the clockwise direction.
		CCW	Performs origin search in the counterclockwise direction.
	<b>Detection Method</b>		Set one of the following three methods to determine the parameters related to the Origin Proximity Input Signal.
		Method 0	The direction is reversed at the Origin Proximity Input Signal. The Origin Input Signal is accepted after the Origin Proximity Input Signal turns ON and then OFF.
		Method 1	The direction is not reversed at the Origin Proximity Input Signal. The Origin Input Signal is accepted after the Origin Proximity Input Signal turns ON.
		Method 2	The Origin Proximity Input Signal is not used. The Origin Input Signal is accepted without using the Origin Proximity Input Signal. Only origin search proximity speed can be the origin search speed.
	<b>Search Operation</b>		Select one of the following two modes for the origin search operation pattern.
		Inverse 1	The direction is reversed when the Limit Input Signal is received while moving in the origin search direction.
		Inverse 2	An error is generated and operation is stopped if the Limit Input Signal is received while moving in the origin search direction.
	<b>Operation Mode</b>		This parameter determines the I/O signals that are used for origin search.
		Mode 0	Use when connecting to a stepping motor that does not have a Positioning Completed Signal.
Mode 1		In this mode, the Positioning Completed Signal from the Servo Drive is not used. Use this mode when you want to reduce the processing time.	
Mode 2		In this mode, the Positioning Completed Signal from the Servo Drive is used. Use this mode when you want high positioning accuracy.	
<b>Origin Input Signal</b>		Specifies the type of Origin Input Signal (NC or NO).	
	NC	Sets a normally closed Origin Input Signal.	
	NO	Sets a normally open Origin Input Signal.	
<b>Proximity Input Signal</b>		Specifies the type of Origin Proximity Input Signal (NC or NO).	
	NC	Sets a normally closed Origin Proximity Input Signal.	
	NO	Sets a normally open Origin Proximity Input Signal.	

Item	Selection	Description	
Define Origin Operation Settings	Search High Speed	Sets the motor's target speed when the origin search is executed. Specify the speed in the number of pulses per second (pps). Setting range: 1 to 100k pps The origin search will not be performed in these cases: Origin search high speed $\leq$ Origin search proximity speed. Origin search proximity speed $\leq$ Origin search initial speed.	
	Search Proximity Speed	Sets the motor's speed after the Origin Proximity Input Signal is detected. Specify the speed in the number of pulses per second (pps). Setting range: 1 to 100k pps The origin search will not be performed in these cases: Origin search high speed $\leq$ Origin search proximity speed. Origin search proximity speed $\leq$ Origin search initial speed.	
	Search Compensation Value	After the origin has been defined, the origin compensation can be set to compensate for a shift in the Proximity Sensor's ON position, motor replacement, or other change. Setting range: -2,147,483,648 to 2,147,483,647 pulses Once the origin has been detected in an origin search, the number of pulses specified in the origin compensation is output, the present position is reset to 0, and the pulse output's No-origin Flag is turned OFF.	
	Search Acceleration Ratio	Sets the motor's acceleration rate when the origin search is executed. Specify the amount to increase the speed (Hz) per 4-ms interval.	Setting range: 1 to 65,535 Hz/4 ms
	Search Deceleration Ratio	Sets the motor's deceleration rate when the origin search function is decelerating. Specify the amount to decrease the speed (Hz) per 4-ms interval.	Setting range: 1 to 65,535 Hz/4 ms
	Positioning Monitor Time	When the operating mode is set to mode 2, this setting specifies how long to wait (in ms) for the Positioning Completed Signal after the positioning operation has been completed, i.e., the pulse output has been completed. A Positioning Timeout Error (error code 0300) will be generated if the motor driver's Positioning Completed Signal does not come ON within the specified time.	Setting range: 0 to 9,999 ms*
	Origin Return	Speed	Sets the motor's target speed when the origin return is executed. Specify the speed in the number of pulses per second (pps).
Acceleration Ratio		Sets the motor's acceleration rate when the origin return operation starts. Specify the amount to increase the speed (Hz) per 4-ms interval.	Setting range: 1 to 65,535 Hz/4 ms
Deceleration Ratio		Sets the motor's deceleration rate when the origin return function is decelerating. Specify the amount to decrease the speed (Hz) per 4-ms interval.	Setting range: 1 to 65,535 Hz/4 ms

\* The actual monitoring time will be the Positioning Monitor Time rounded up to the nearest 10-ms unit + 10 ms max. If the Positioning Monitor Time is set to 0, the function will be disabled and the Unit will continue waiting for the Positioning Completed Signal to come ON. (A Positioning Timeout Error will not be generated.)

**Note** The power supply must be restarted after the PLC Setup is transferred in order to enable the settings for using the origin search.

## 12-4-4 Origin Search Instructions

### Origin Search Instruction: ORG

Execute the ORG instruction in the ladder program to perform an origin search with the specified parameters.

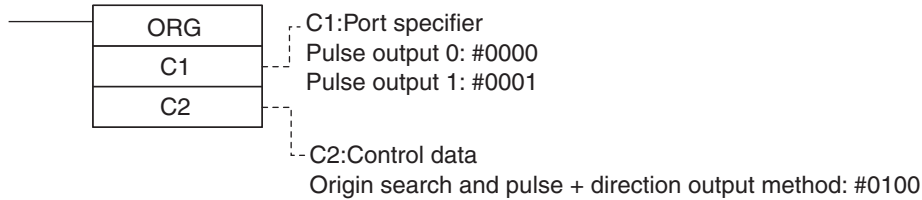

#### Precautions for Correct Use

##### Limit Sensor Application

Create a program that can identify the limit sensor when using the origin search. The OUT instruction is used in the ladder program to write signals received from the CW limit sensor and CCW limit sensor connected to normal inputs to the Auxiliary Area bits.

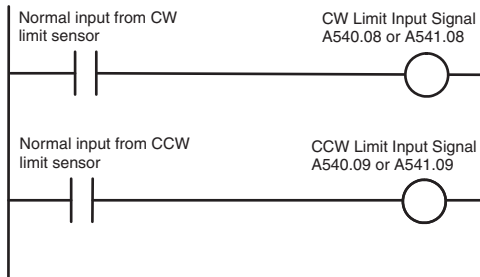

##### Bits Written in the Auxiliary Area

Auxiliary Area		Name	
Word	Bit		
A540	08	Pulse Output 0 CW Limit Input Signal	Signals received from external sensors connected to normal inputs must be written to the Auxiliary Area bits in the user program.
	09	Pulse Output 0 CCW Limit Input Signal	
A541	08	Pulse Output 1 CW Limit Input Signal	
	09	Pulse Output 1 CCW Limit Input Signal	

## 12-4-5 Origin Search Operations

### Operating Mode

The operating mode parameter specifies the kind of I/O signals that are used in the origin search.

I/O signal		Mode 0	Mode 1	Mode 2
Driver		Stepping motor*	Servomotor	
Operation	Origin Input Signal	Inputs signals are arranged so deceleration starts when the Origin Proximity Input Signal is received and then the Origin Input Signal is received while the motor is decelerating to the origin search proximity speed. If an Origin Input Signal is detected during this deceleration, an Origin Input Signal error will occur and the motor will decelerate to a stop.	Even if an Origin Input Signal is received during deceleration, it is ignored. After the motor has reached the origin search proximity speed and the Origin Input Signal is received, the motor stops, completing the origin search process.	
	Positioning Completed Signal	The Positioning Completed Signal from the driver is not connected. *	The Positioning Completed Signal from the driver is not connected. Use this mode when you want to reduce the processing time, even at the expense of positioning accuracy.	After detecting the origin, the origin search process is not completed until the Positioning Completed Signal is received. Use this mode when you want high positioning accuracy.

\* There are stepping motor drivers that are equipped with a Positioning Completed Signal like a servomotor. Operating modes 1 and 2 can be used with these stepping motor drivers.

The use of an error counter reset output and positioning completed input depends on the mode as described in the following table.

I/O signal	Mode 0	Mode 1	Mode 2
Origin Input Signal	Connected to the open-collector output from a sensor or other device.	Connected to the phase-Z signal from the Servo Drive.	Connected to the phase-Z signal from the Servo Drive.
Error counter reset output	Not used. (The origin search operation is completed when the origin is detected.)	Connected to the error counter reset of the Servo Drive.	Connected to the error counter reset of the Servo Drive.
Positioning completed input	Not used.	Not used.	Connected to the Positioning Completed Signal from the Servo Drive.

## Operations Detecting the Origin during Deceleration from High Speed

### ● Operating Mode 0 (without Error Counter Reset Output, without Positioning Completed Input)

Connect the sensor's open-collector output signal to the Origin Input Signal. The Origin Input Signal's response time is 0.1 ms when set as NO contacts.

When the Origin Proximity Input Signal is received, the motor will begin decelerating from the origin search high speed to the origin search proximity speed. In this operating mode, the Origin Input Signal will be detected if it is received during this deceleration and an Origin Input Signal Error (error code 0202) will be generated. In this case, the motor will decelerate to a stop.

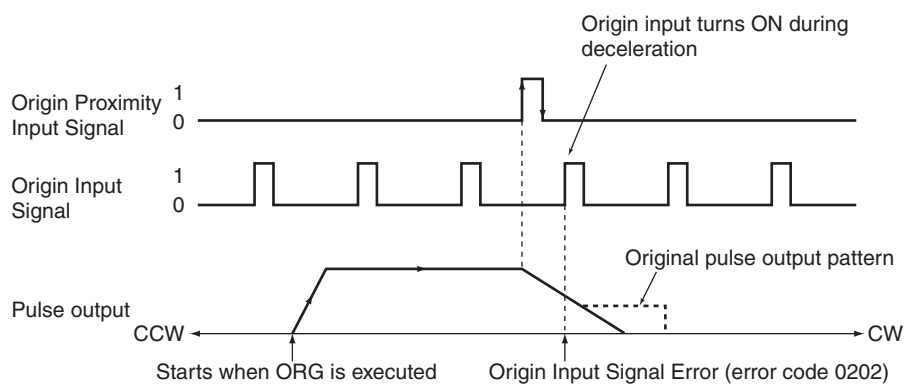

● **Operating Mode 1 (with Error Counter Reset Output, without Positioning Completed Input)**

Connect the phase-Z signal from the Servo Drive to the Origin Input Signal.

When the Origin Input Signal is received, the pulse output will be stopped and the Error Counter Reset Signal will be output for about 20 to 30 ms.

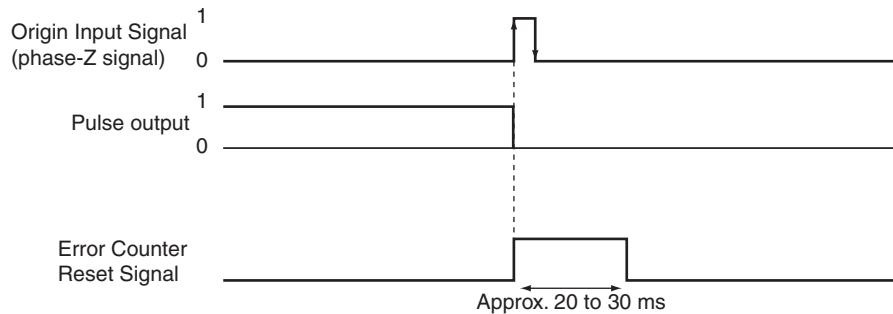

Though the Origin Proximity Input Signal is received, the signal will be ignored and the motor will begin decelerating from the origin search high speed to the origin search proximity speed. In this operating mode, the motor will stop at the Origin Input Signal after deceleration is completed.

**Operating Mode 1 with Origin Proximity Input Signal Reverse (Origin Detection Method Setting = 0)**

The Origin Input Signal can be detected immediately after the Origin Proximity Input Signal turns OFF if the deceleration time is short, e.g., when starting from within the Origin Proximity Input Signal. Set an Origin Proximity Input Signal dog setting that is long enough (longer than the deceleration time.)

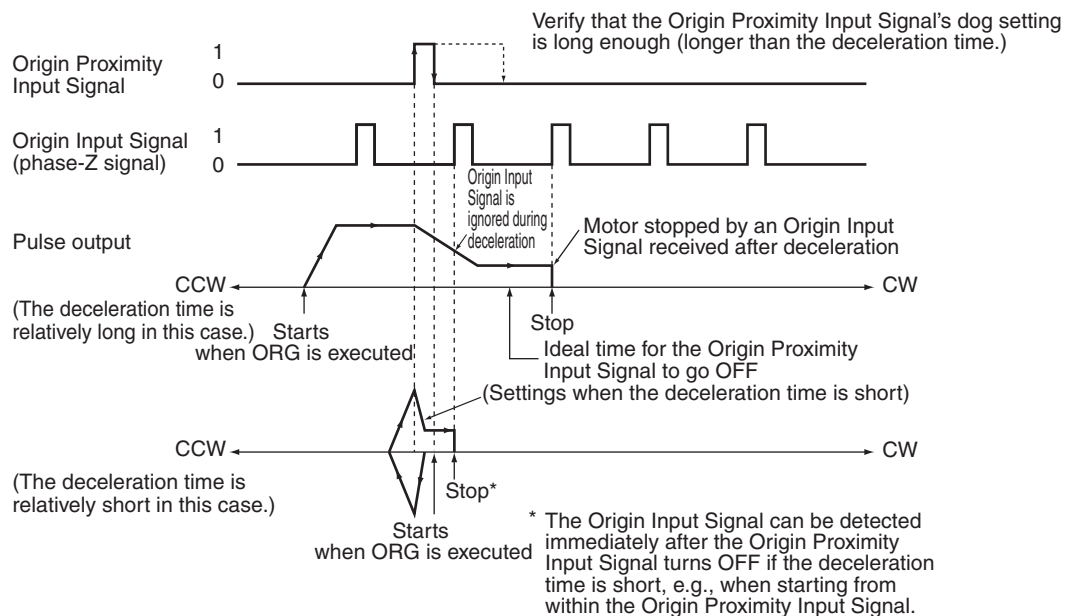

### Operating Mode 1 without Origin Proximity Input Signal Reverse (Origin Detection Method Setting = 1)

Depending on the length of the deceleration time, the stopping position may change when the Origin Input Signal is detected during deceleration.

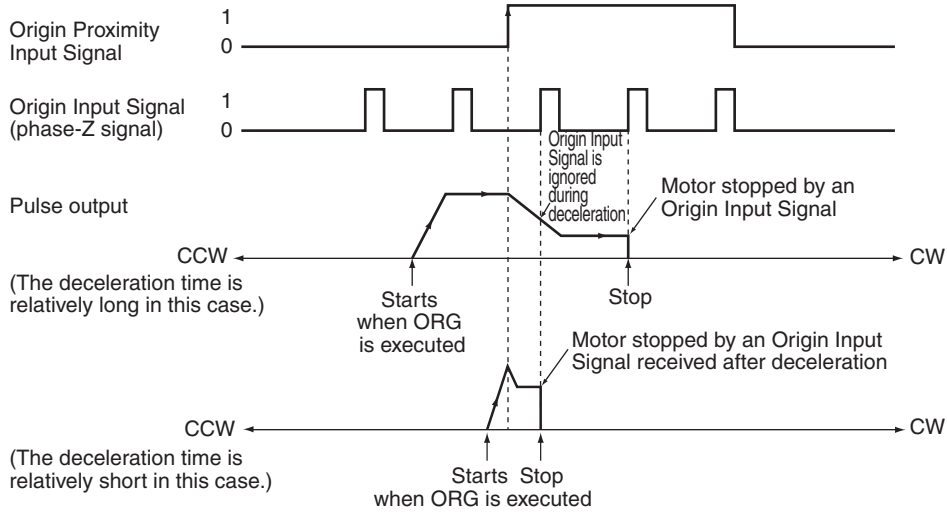

### ● Operating Mode 2 (with Error Counter Reset Output, with Positioning Completed Input)

This operating mode is the same as mode 1, except the Positioning Completed Signal (INP) from the Servo Drive is used. Connect the Positioning Completed Signal from the Servo Drive to a normal input.

If origin compensation is not being applied, the Positioning Completed Signal is checked after the Error Counter Reset Output. If origin compensation is being applied, the Positioning Completed Signal is checked after the compensation operation is completed.

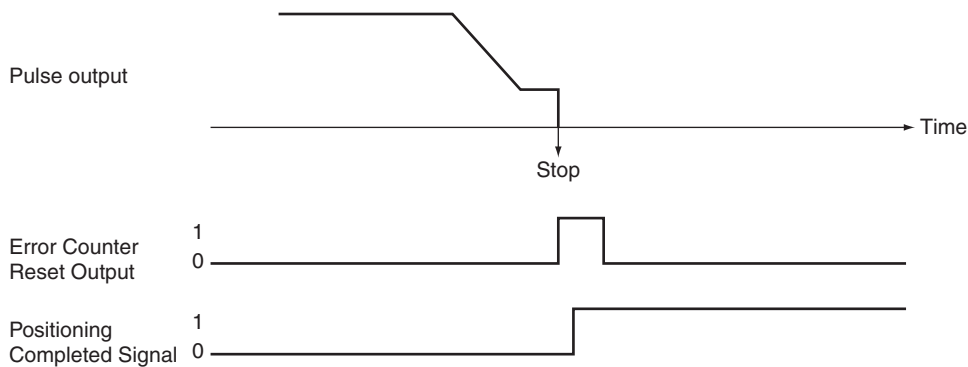



## Origin Detection Method Setting

- **Origin Detection Method 0: Origin Proximity Input Signal Reversal Required (Recommended Method)**

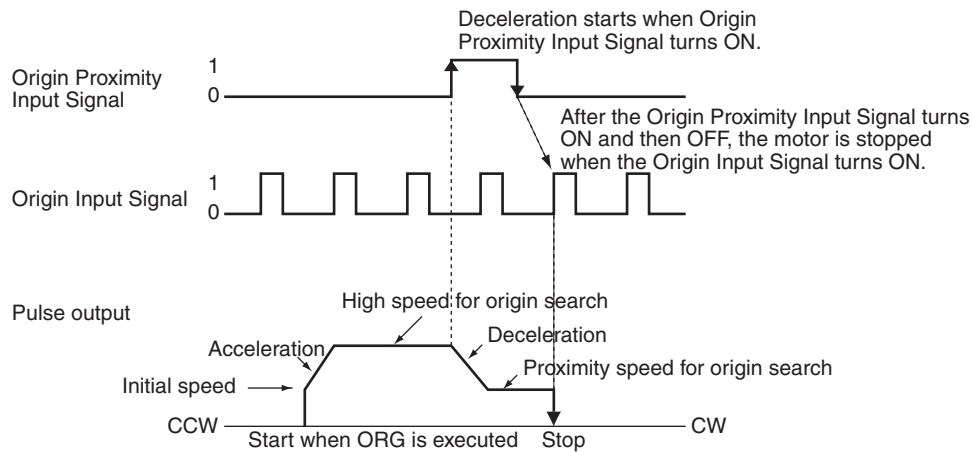

- **Origin Detection Method 1: Origin Proximity Input Signal Reversal Not Required**

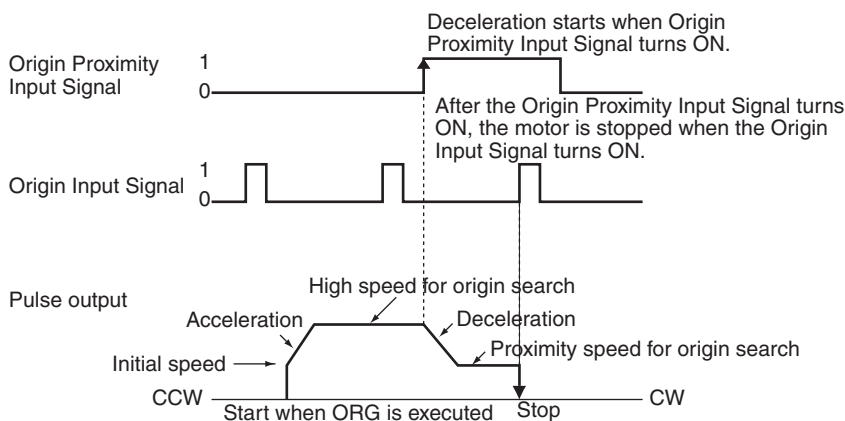

- **Origin Detection Method 2: Origin Proximity Input Signal Not Used**

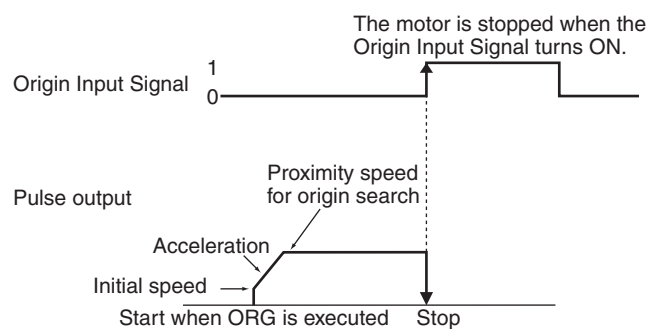

## Operation Patterns for Origin Search Operating Mode and Origin Detection Method Settings

The following examples show how the operation patterns are affected by the origin detection method and origin search operating mode.

These examples have a CW origin search direction. (The search direction and Limit Input Signal direction would be different for an origin search in the CCW direction.)

Method 0 is the recommended method for reversal mode 1 (Inverse 1).

### ● Using Reversal Mode 1 (Inverse 1)

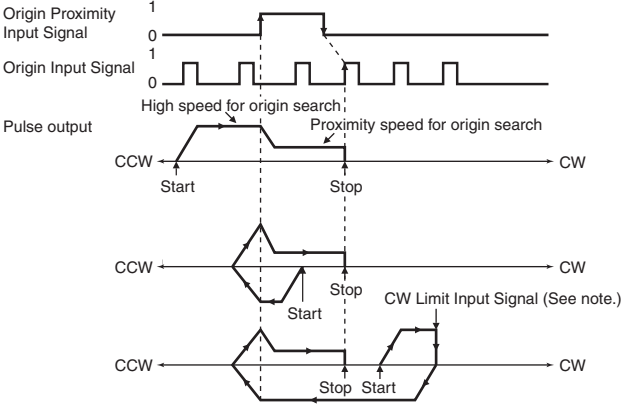
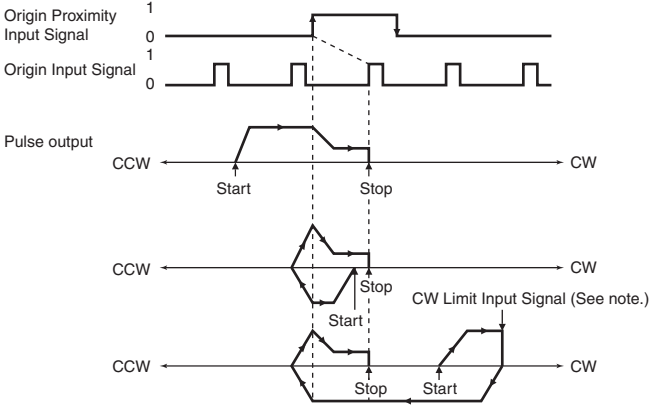
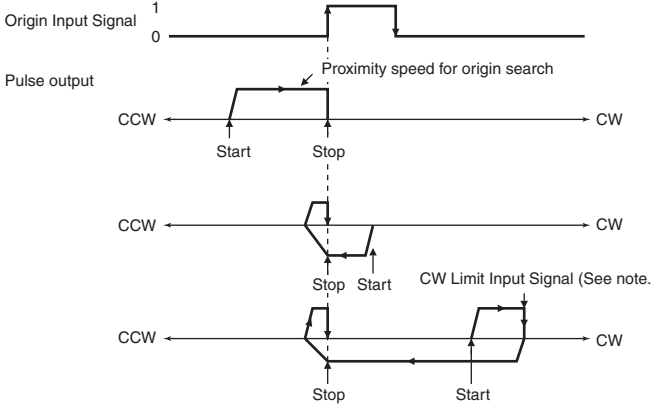
Origin search operation Origin detection method	Reversal mode 1 (Inverse 1)
<p><b>0: Origin Proximity Input Signal reversal required. (Recommended method)</b></p>	 <p><b>Note</b> When the Limit Input Signal is received, the motor stops without deceleration, reverses direction, and accelerates.</p>
<p><b>1: Origin Proximity Input Signal reversal not required.</b></p>	 <p><b>Note</b> When the Limit Input Signal is received, the motor stops without deceleration, reverses direction, and accelerates.</p>
<p><b>2: Origin Proximity Input Signal not used.</b></p>	 <p><b>Note</b> When the Limit Input Signal is received, the motor stops without deceleration, reverses direction, and accelerates.</p>

● Using Reversal Mode 2 (Inverse 2)

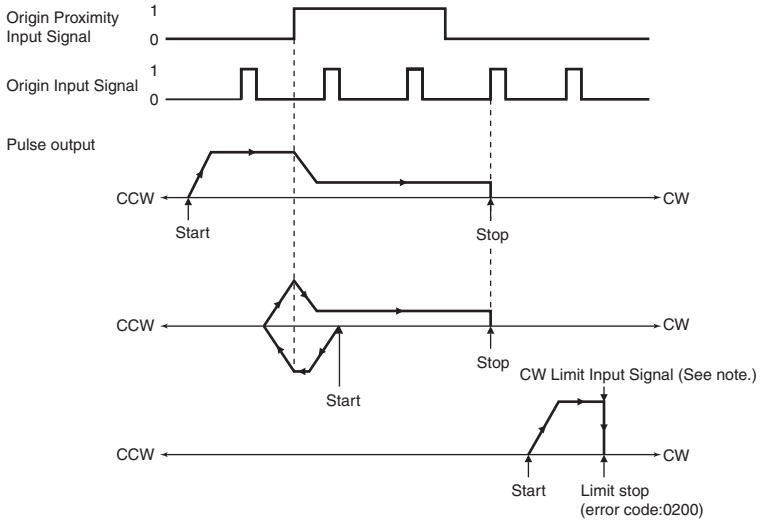
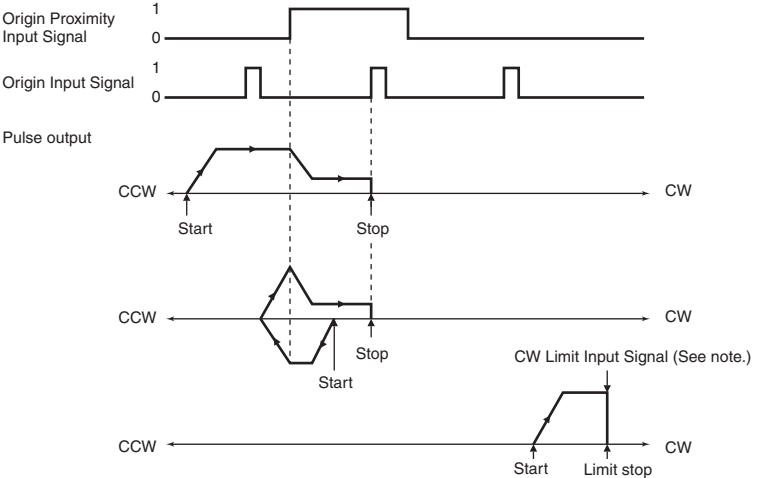
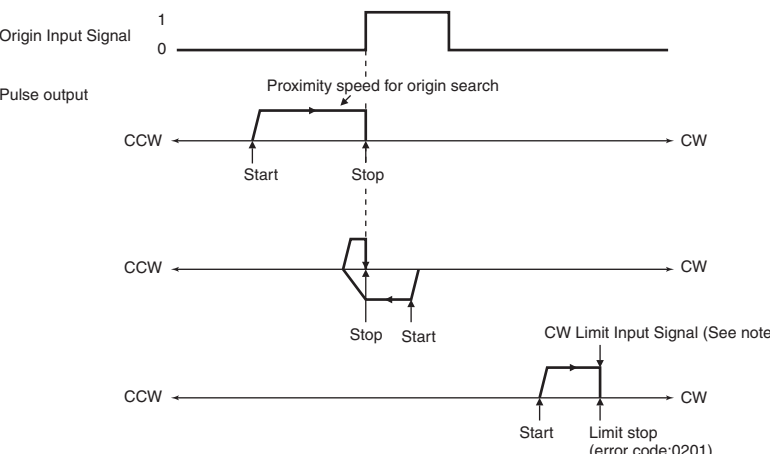
Origin search operation Origin detection method	Reversal mode 2 (Inverse 2)
<p>0: Origin Proximity Input Signal reversal required.</p>	 <p><b>Note</b> When the Limit Input Signal is received, the motor stops without deceleration.</p>
<p>1: Origin Proximity Input Signal reversal not required.</p>	 <p><b>Note</b> When the Limit Input Signal is received, the motor stops without deceleration.</p>
<p>2: Origin Proximity Input Signal not used.</p>	 <p><b>Note</b> When the Limit Input Signal is received, the motor stops without deceleration.</p>

## 12-4-6 Origin Return

It is the function to move the origin to the defined position by origin searches or changing PVs.

An origin return operation moves the motor to the origin position from any other position. The origin return operation is controlled by ORG.

The origin return operation returns the motor to the origin by starting at the specified speed, accelerating to the target speed, moving at the target speed, and then decelerating to a stop at the origin position.

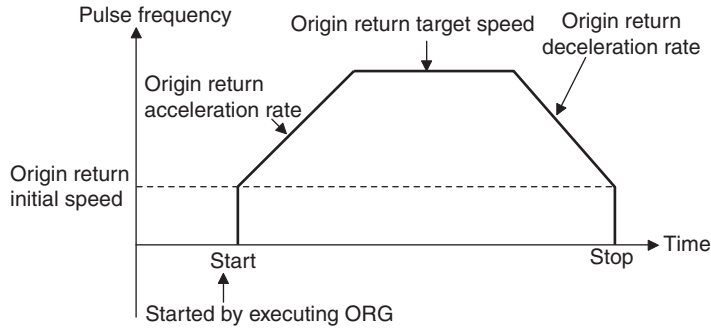

## PLC Setup

The various origin return parameters are set on the Pulse Output 0 Tab Page in the PLC Setup.

### ● Origin Return Parameters

	Name	Setting	Setting range
Base Settings	Search/Return Initial Speed	Sets the motor's starting speed when the origin return is executed. Specify the speed in the number of pulses per second (pps).	0 to 100k pps
Origin Return	Speed	Sets the motor's target speed when the origin return is executed. Specify the speed in the number of pulses per second (pps).	1 to 100k pps
	Acceleration Ratio (Rate)	Sets the motor's acceleration rate when the origin return function is accelerating. Specify the amount to increase the speed (Hz) per 4-ms interval.	1 to 65,535 (Hz/4ms)
	Deceleration Ratio (Rate)	Sets the motor's deceleration rate when the origin return function is decelerating. Specify the amount to decrease the speed (Hz) per 4-ms interval.	1 to 65,535 (Hz/4ms)

## Origin Return Instruction

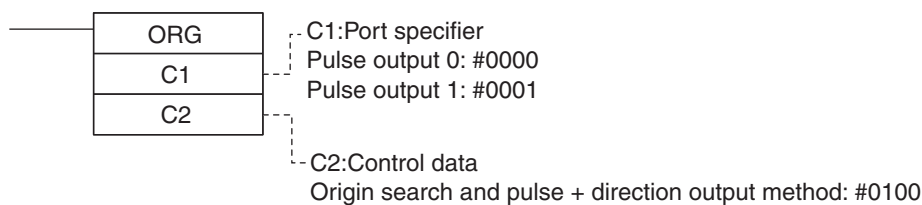

**Note** An instruction execution error will occur if the origin is not defined (relative coordinate system) when the ORG instruction is executed to perform an origin return operation.

## 12-4-7 Changing the Present Value of the Pulse Output

The present value of the pulse output can be changed by using the INI instruction. To define the present value as the origin, set the pulse output PV to 0 using the INI instruction.

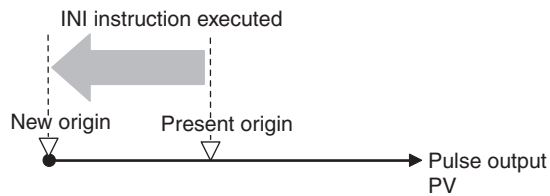

### ● Example: Setting the Present Position as the Origin

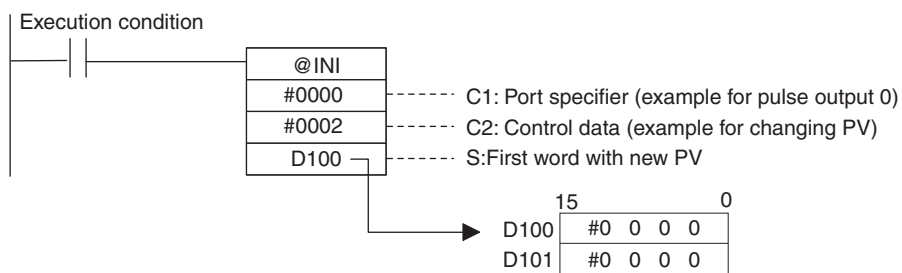

Operands		Settings	
C1	Port specifier	#0000	Pulse output 0
		#0001	Pulse output 1
C2	Control data	#0002	Changes PV
S	First word with new PV	Store the new PV in S and S+1 (32 bits).	

## 12-5 Reading the Pulse Output Present Value

The present value of a pulse output can be read in the following two ways.

- Value refreshed at the I/O refresh timing → Read PV from Auxiliary Area.
- Value updated when a program is executed → Read PV by executing a PRV instruction.

### Reading the PV Refreshed at the I/O Refresh Timing

The PV that is stored in the following words can be read using the MOVL instruction or other instructions.

Read PV	Auxiliary Area words
Pulse output 0	A277 (upper digits) and A276 (lower digits)
Pulse output 1	A279 (upper digits) and A278 (lower digits)

### Reading the Value When a Program is Executed

#### ● Reading the Pulse Output PV with a PRV Instruction

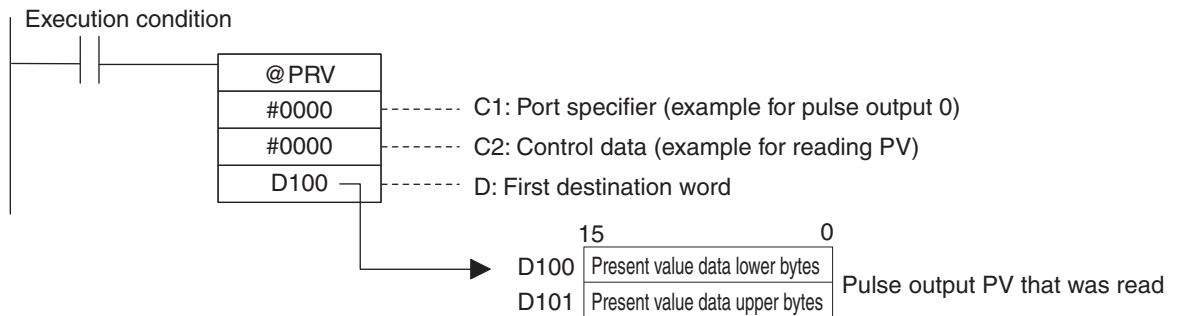

## 12-6 Related Auxiliary Area Flags

### Auxiliary Area Allocations

Name	Description	Values	Pulse output 0	Pulse output 1
Pulse Output PV Storage Words	PV range: 8000 0000 to 7FFF FFFF hex (-2,147,483,648 to 2,147,483,647)	Leftmost 4 digits	A277	A279
		Rightmost 4 digits	A276	A278
Pulse Output Reset Bit	The pulse output PV will be cleared when this bit is turned ON.	0: Not cleared. 1: Clear PV.	A540.00	A541.00
CW Limit Input Signal Flag	This flag shows the status of the CW Limit Input Signal, which is used in the origin search.  The status of the signal from the CW limit input sensor connected to a normal input must be written to A540.08 or A541.08.	ON when turned ON from an external input.	A540.08	A541.08
CCW Limit Input Signal Flag	This flag shows the status of the CCW Limit Input Signal, which is used in the origin search.  The status of the signal from the CCW limit input sensor connected to a normal input must be written to A540.09 or A541.09.	ON when turned ON from an external input.	A540.09	A541.09
Positioning completed input signal	This flag shows the status of the positioning completed input signal, which is used in the origin search.  The status of the Positioning Completed Signal from the Servo Drive connected to a normal input must be written to A540.10 or A541.10.	ON when turned ON from an external input.	A540.10	A541.10
Accel/Decel Flag	ON when pulses are being output according to an ORG, ACC or PLS2 instruction and the output frequency is being changed in steps (accelerating or decelerating).	0: Constant speed 1: Accelerating or decelerating	A280.00	A281.00
Overflow/Underflow Flag	ON when an overflow or underflow has occurred in the pulse output PV.	0: Normal 1: Overflow or underflow	A280.01	A281.01
Output Amount Set Flag	ON when the number of output pulses has been set with the PULS instruction.	0: No setting 1: Setting made	A280.02	A281.02
Output Completed Flag	ON when the number of output pulses set with the PULS/PLS2 instruction has been output.	0: Output not completed. 1: Output completed.	A280.03	A281.03
Output In-progress Flag	ON when pulses are being output from the pulse output.	0: Stopped 1: Outputting pulses.	A280.04	A281.04
No-origin Flag	ON when the origin has not been defined for the pulse output.	0: Origin defined. 1: Origin undefined.	A280.05	A281.05
At-origin Flag	ON when the pulse output PV matches the origin (0).	0: Not stopped at origin. 1: Stopped at origin.	A280.06	A281.06
Output Stopped Error Flag	ON when an error occurred while outputting pulses in the origin search function.	0: No error 1: Stop error occurred.	A280.07	A281.07
Stop Error Code	When a Pulse Output Stop Error occurs, the error code is stored in that pulse outputs corresponding Stop Error Code word.	–	A444	A445

# 12-7 Application Examples

## 12-7-1 Vertically Conveying PCBs (Multiple Progressive Positioning)

### Specifications and Operation

#### ● Outline

- (1) PCBs with components mounted are stored in a stocker.
- (2) When a stocker becomes full, it is moved to the conveyance point.

#### Positioning Operation for Vertical Conveyor

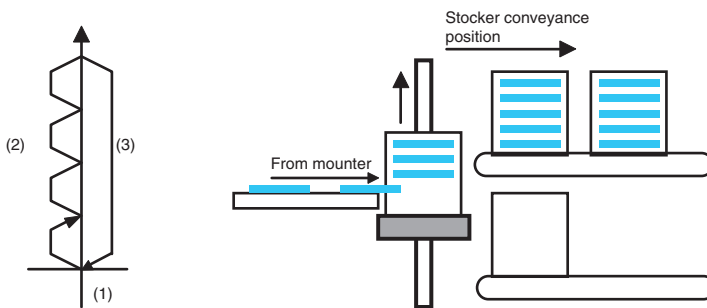

#### ● Operation Pattern

- (1) An origin search is performed.
- (2) Fixed-distance positioning is repeated.
- (3) The system is returned to the original position.

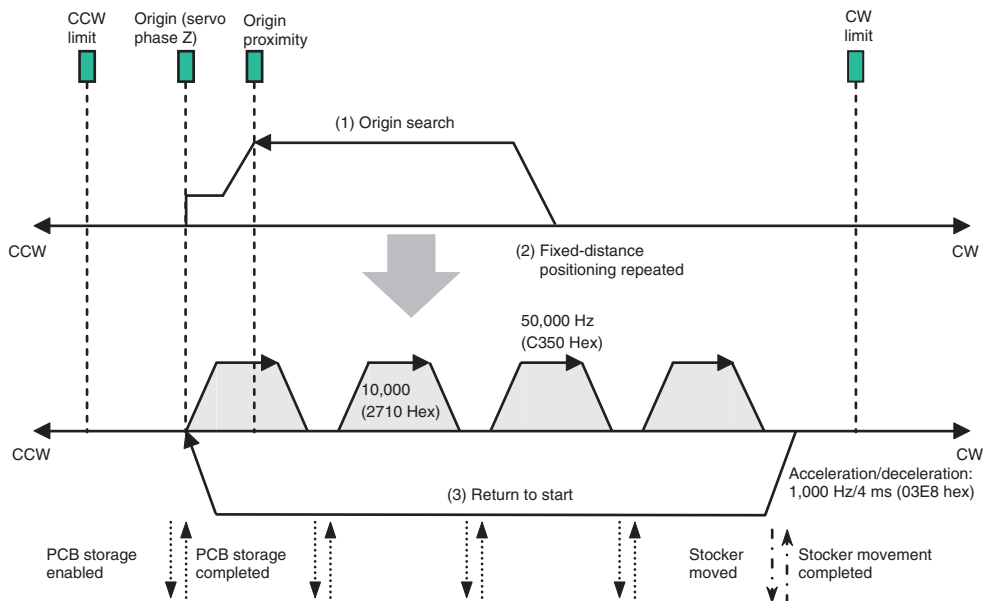



● Wiring Example Using SmartStep A-series Servo Drive

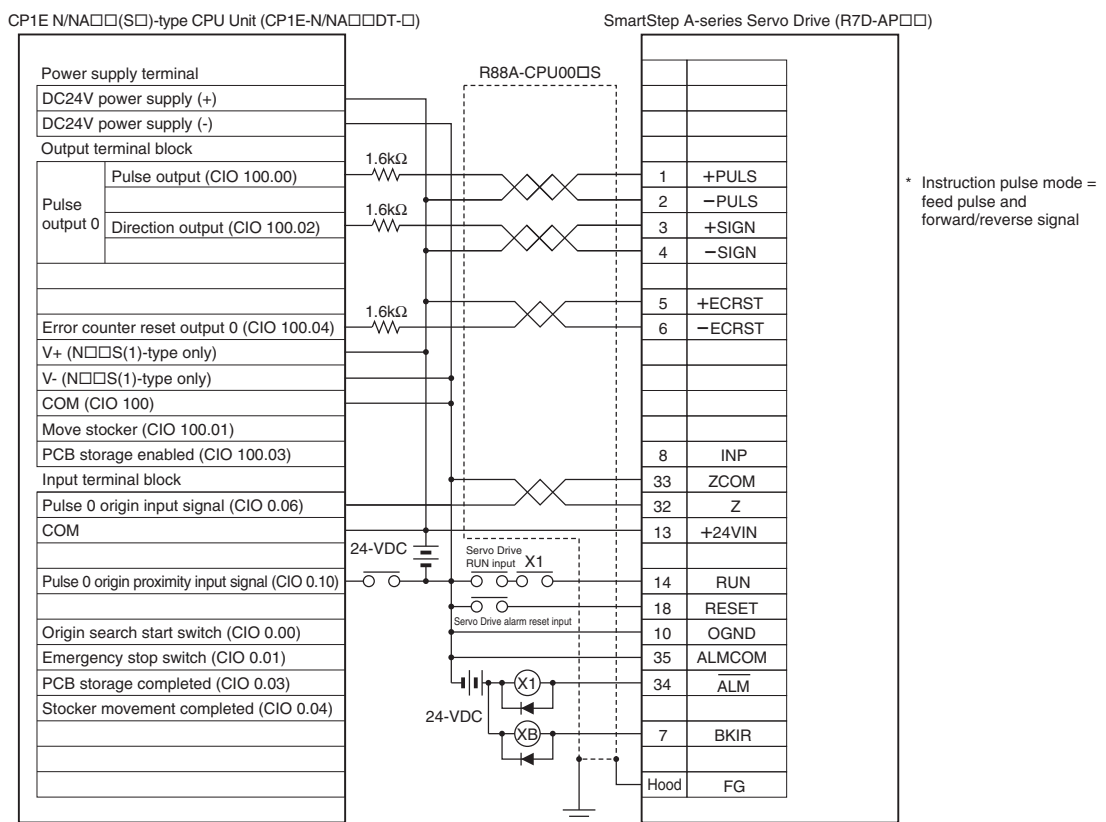
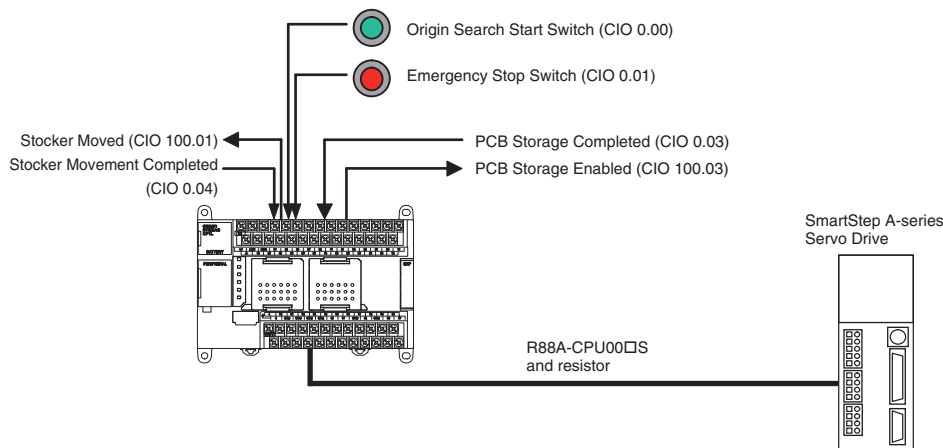

Only N□□S(1)-type CPU Units can wire V+ and V-. Do not wire them in N□□-type CPU Units.

● Operation

- 1 An origin search is performed using the Origin Search Start Switch (CIO 0.00).
- 2 When the origin search is finished, the PCB Storage Enabled Output (CIO 100.03) is turned ON.
- 3 When a PCB has been stored, the stoker is raised (relative positioning) using the PCB Storage Completed Input (CIO 0.03).
- 4 Storing PCBs is repeated until the stoker is full.
- 5 The number of PCBs in the stoker is counted with counter C0 by counting the number of times the stoker is raised.
- 6 When the stoker is full, it is moved (CIO 100.01) and only the conveyor is lowered (absolute positioning) when stoker movement is completed (CIO 0.04).
- 7 An emergency stop is executed to stop pulse output with the Emergency Stop Switch Input (CIO 0.01).

## Preparations

### ● PLC Setup

#### Setting

Use define origin operation for pulse output 0.

**Note** The Use define origin operation setting is read from the PLC Setup when the power supply is turned ON.

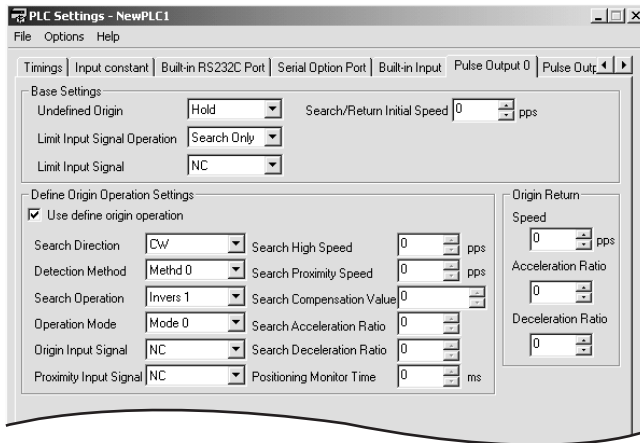

### ● DM Area Settings

- Settings for PLS2 for Fixed-distance Positioning (D0 to D7)

Setting details	Address	Data
Acceleration rate: 1,000 Hz/4 ms	D0	#03E8
Deceleration rate: 1,000 Hz/4 ms	D1	#03E8
Target frequency: 50,000 Hz	D2	#C350
	D3	#0000
Number of output pulses: 10,000 pulses	D4	#2710
	D5	#0000
Starting frequency: 0 Hz	D6	#0000
	D7	#0000

- Settings for PLS2 to Return to Start (D10 to D17)

Setting details	Address	Data
Acceleration rate: 300 Hz/4 ms	D10	#012C
Deceleration rate: 200 Hz/4 ms	D11	#00C8
Target frequency: 50,000 Hz	D12	#C350
	D13	#0000
Number of output pulses: 0 pulse	D14	#0000
	D15	#0000
Starting frequency: 100 Hz	D16	#0064
	D17	#0000

- Number of Repeats of Fixed-distance Positioning Operation (D20)

Setting details	Address	Data
Number of repeats of fixed-distance positioning operation (number of PCBs in stocker)	D20	#000F

# Ladder Program

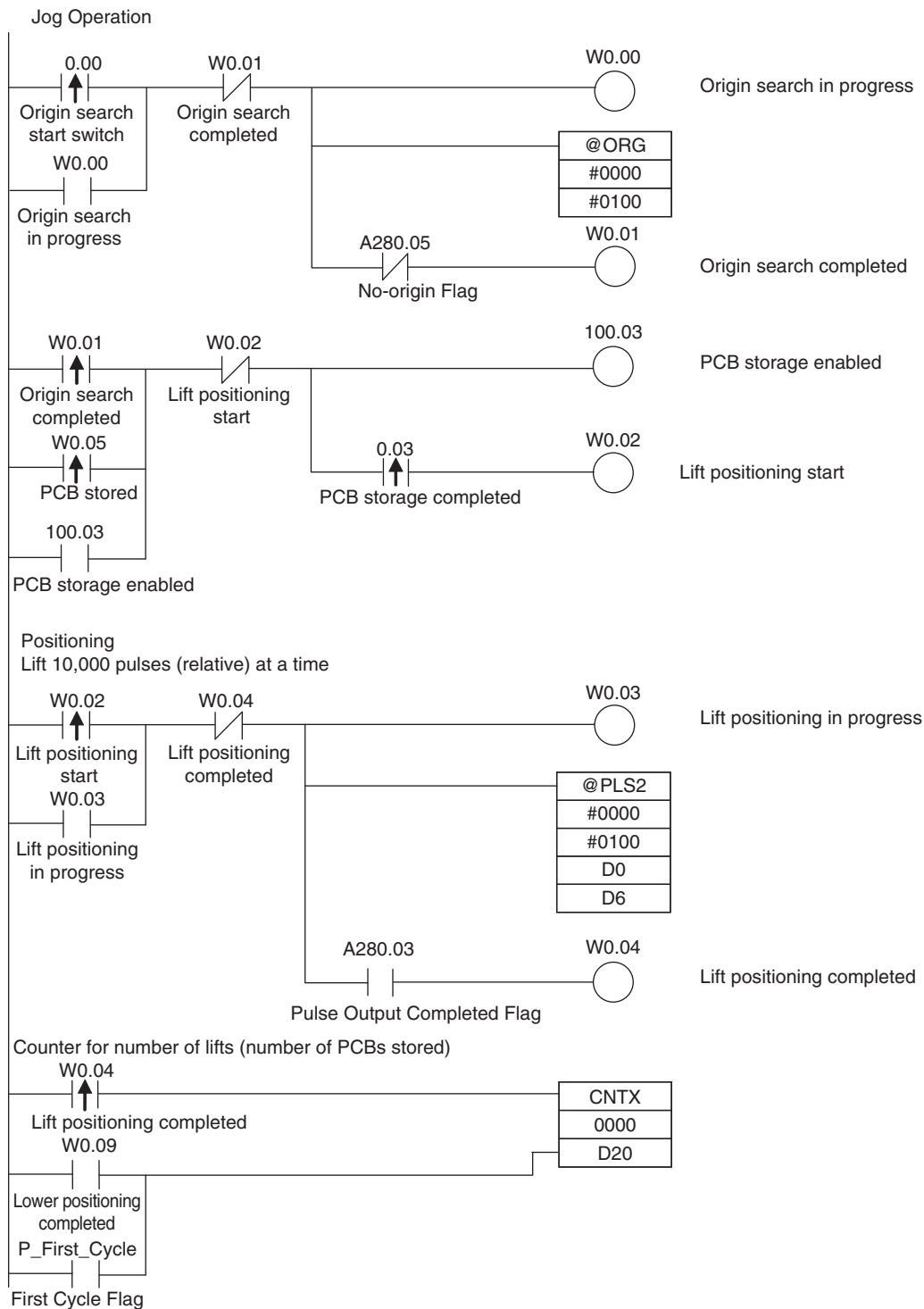

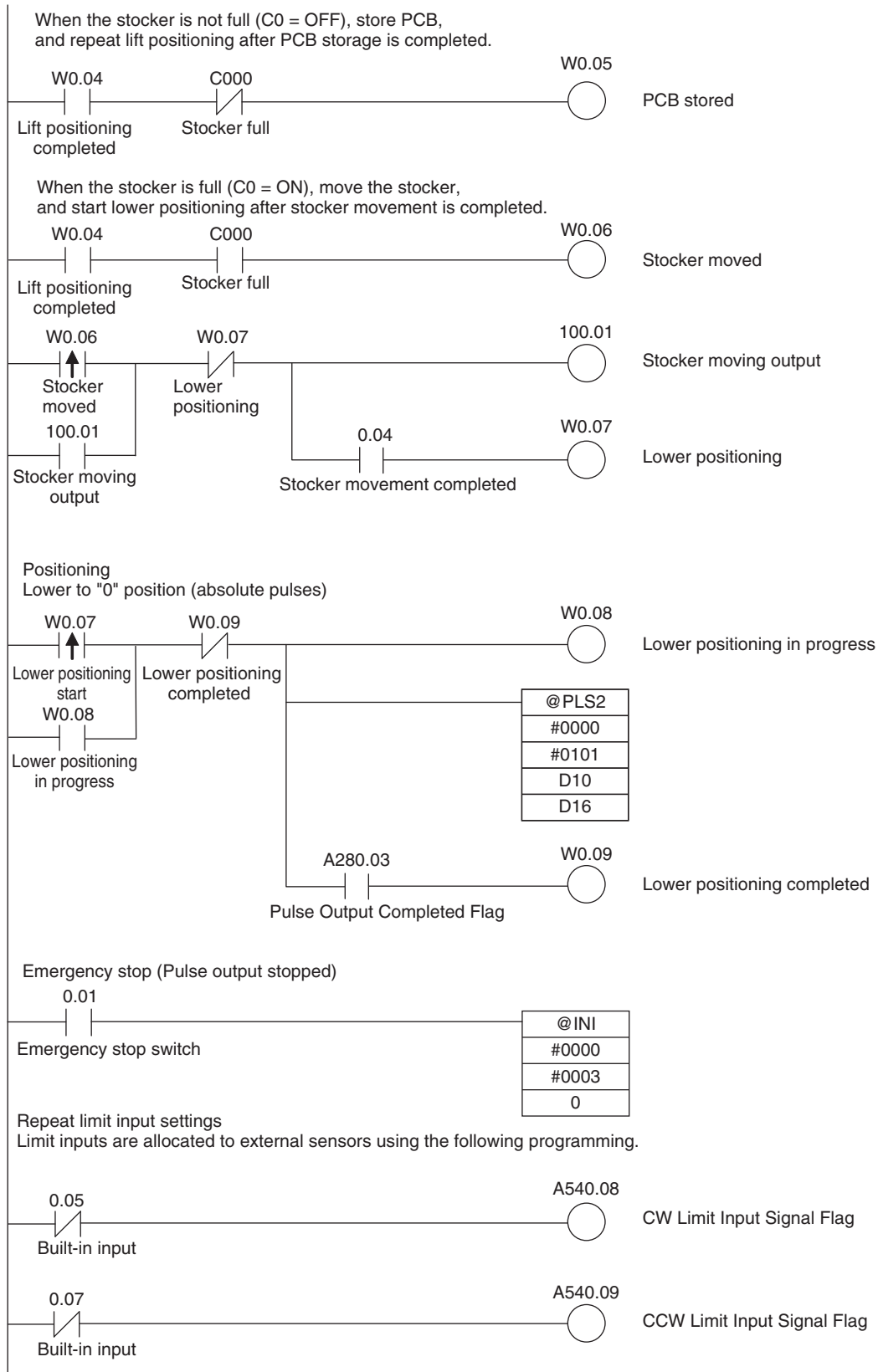

## 12-7-2 Feeding Wrapping Material: Interrupt Feeding

### Specifications and Operation

#### ● Feeding Wrapping Material in a Vertical Pillow Wrapper

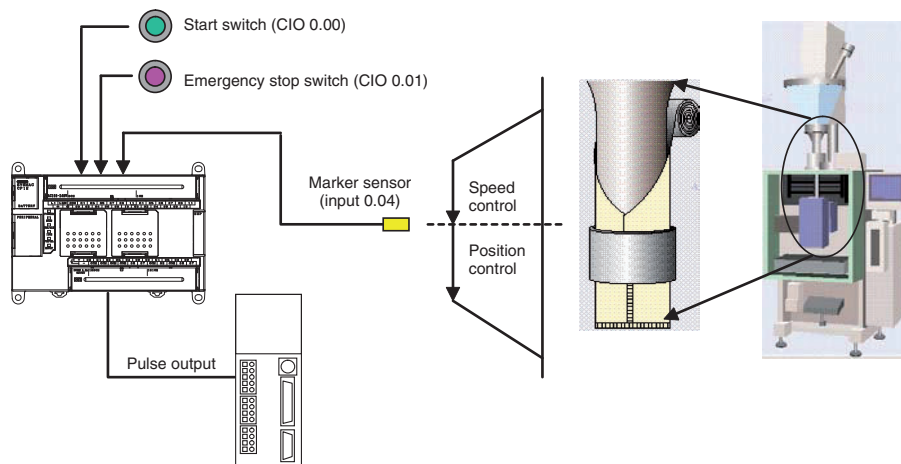

#### ● Operation Pattern

Speed control is used to feed wrapping material to the initial position. When the marker sensor input is received, fixed-distance positioning is performed before stopping.

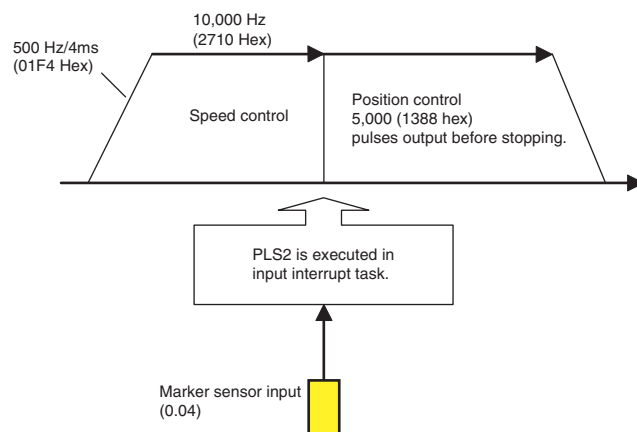

#### ● Operation

- 1** Speed control is used to feed wrapping material to the initial position when the Start Switch (CIO 0.00) is activated.
- 2** When the Marker Sensor Input (CIO 0.04) is received, the PLS2 instruction is executed in interrupt task 4.
- 3** Fixed-distance positioning is executed with the PLS2 instruction before stopping.
- 4** An emergency stop is executed to stop pulse output with the Emergency Stop Switch input (CIO 0.01).

## Preparations

### ● PLC Setup

Setting
Enable using built-in input IN4 as an interrupt input.

**Note** The interrupt input setting is read from the PLC Setup when the power supply is turned ON.

### ● DM Area Settings

- Speed Control Settings to Feed Wrapping Material to Initial Position

Setting	Address	Data
Acceleration/deceleration rate: 500 Hz/4 ms	D0	#01F4
Target frequency: 10,000 Hz	D1	#2710
	D2	#0000

- Positioning Control Settings for Wrapping Material

Setting	Address	Data
Acceleration rate: 500 Hz/4 ms	D10	#01F4
Deceleration rate: 500 Hz/4 ms	D11	#01F4
Target frequency: 10,000 Hz	D12	#2710
	D13	#0000
Number of output pulses: 5,000 pulses	D14	#1388
	D15	#0000
Starting frequency: 0 Hz	D16	#0000
	D17	#0000

## Ladder Program

### ● Cyclic Task Program (Executed at Startup)

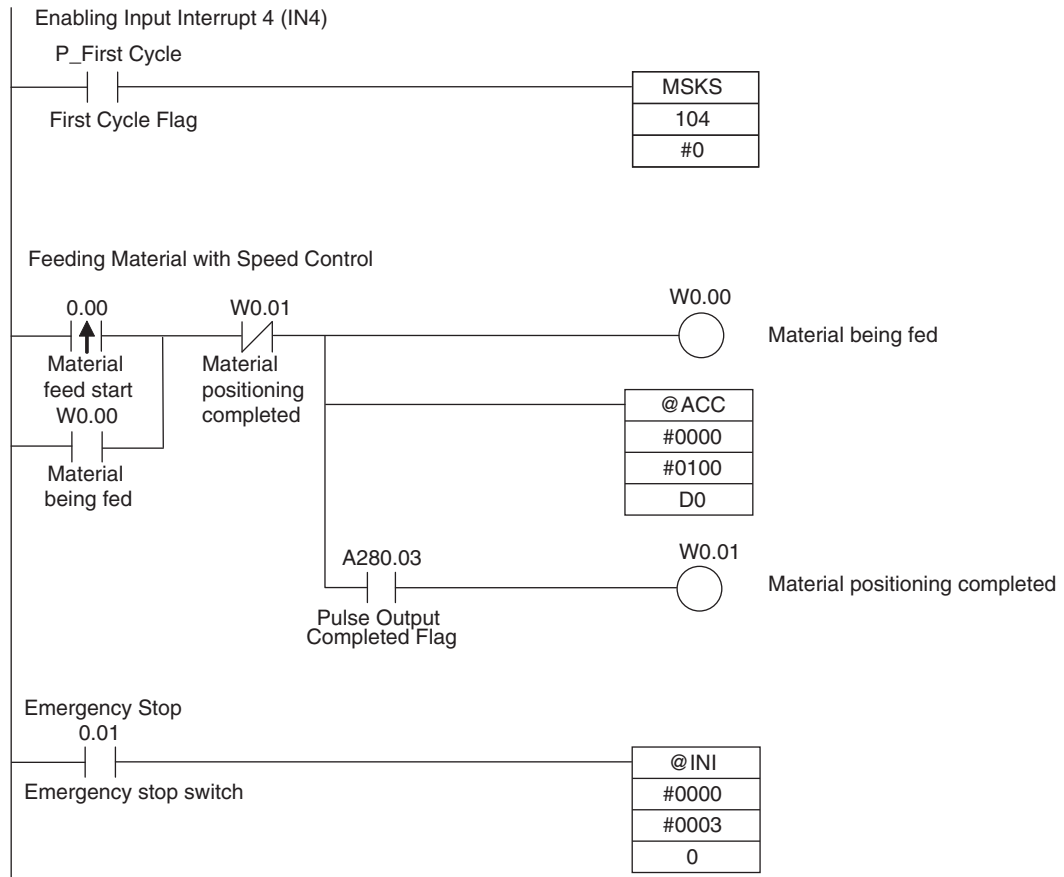

### ● Program for Interrupt Task 4

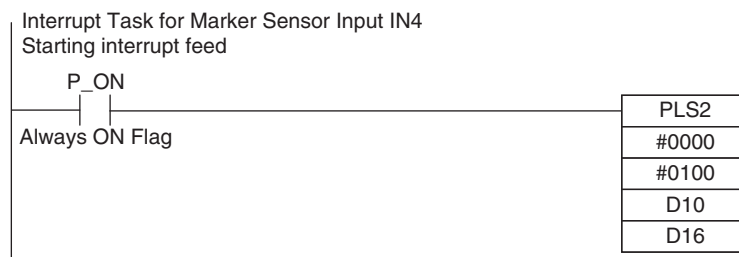

## 12-8 Precautions when Using Pulse Outputs

### Movement Direction when Specifying Absolute Pulses

When operating with the absolute pulse specification, the movement direction (CW/CCW) is selected automatically based on the relationship between the pulse output PV when the instruction is executed and the specified target position. The direction (CW/CCW) specified in an ACC, SPED or PLS2 instruction is not effective.

### Using CW/CCW Limit Inputs for Pulse Output Functions other than Origin Searches

Pulse outputs will stop according to the PLC Setup when either the CW or CCW Limit Input Signals turns ON. It is also possible to select whether or not the defined origin will be cleared when a CW or CCW Limit Input Signal turns ON for a pulse output function.

### Difference between Set Frequencies and Actual Frequencies

The CP1E CPU Unit's pulse output frequency is determined by dividing the source clock frequency (32 MHz) by an integer ratio. Consequently, there may be a slight difference between the set frequency and the actual frequency, and that difference increases as the frequency increases. The actual frequency can be calculated from the following equations.

#### ● Pulse Output System

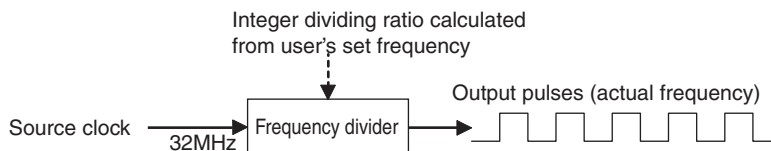

#### ● Equations

$$\text{Actual frequency (Hz)} = \frac{\text{Source clock frequency}}{\text{Dividing ratio}}$$

$$\text{Dividing ratio} = \text{INT} \left( \frac{\text{Source clock frequency} \times 2 + \text{Set frequency}}{\text{Set frequency (Hz)} \times 2} \right)$$

The INT function extracts an integer from the fraction. The non-integer remainder is rounded.



## ● Differences between Set Frequencies and Actual Frequencies

Source clock frequency: 32 MHz

Set frequency (kHz)	Actual frequency (kHz)
99.844 to 100.000	100.000
99.534 to 99.843	99.688
⋮	⋮
50.040 to 50.117	50.078
49.961 to 50.039	50.000
49.884 to 49.960	49.921
⋮	⋮
10.002 to 10.004	10.003
9.999 to 10.001	10.000
9.996 to 9.998	9.996

## Combinations of Pulse Control Instructions

The following tables show when a second pulse control instruction can be started if a pulse control operation is already being executed.

A second independent-mode positioning instruction can be started if an independent-mode positioning instruction is being executed, and a second continuous-mode speed control instruction can be started if a continuous-mode speed control instruction is being executed. Operation cannot be switched between the independent and continuous modes, although a PLS2 instruction can be executed while a ACC instruction (continuous mode) is being executed.

It is possible to start another operation during acceleration/deceleration and start another positioning instruction during positioning

●:Can be executed. ×:Error occurs.

Instruction being executed		Instruction being started						
		INI	SPED (Independent)	SPED (Continuous)	ACC (Independent)	ACC (Continuous)	PLS2	ORG
SPED (Independent)		●	● (*1)	×	● (*3)	×	×	×
SPED (Continuous)		●	×	● (*2)	×	● (*5)	×	×
ACC (Independent)	Steady speed	●	×	×	● (*4)	×	● (*6)	×
	Accelerating or decelerating	●	×	×	● (*4)	×	● (*6)	×
ACC (Continuous)	Steady speed	●	×	×	×	● (*5)	● (*7)	×
	Accelerating or decelerating	●	×	×	×	● (*5)	● (*7)	×
PLS2	Steady speed	●	×	×	● (*4)	×	● (*8)	×
	Accelerating or decelerating	●	×	×	● (*4)	×	● (*8)	×
ORG	Steady speed	●	×	×	×	×	×	×
	Accelerating or decelerating	●	×	×	×	×	×	×

\*1 SPED (Independent) to SPED (Independent)

- The number of output pulses cannot be changed.
- The frequency can be changed.

- \*2 SPED (Continuous) to SPED (Continuous)
  - The frequency can be changed.
- \*3 SPED (Independent) to ACC (Independent)
  - The number of output pulses cannot be changed.
  - The frequency can be changed.
  - The acceleration/deceleration rate can be changed.
- \*4 ACC (Independent) to ACC (Independent) or PLS2 to ACC (Independent)
  - The number of output pulses cannot be changed.
  - The frequency can be changed.
  - The acceleration/deceleration rate can be changed. (The rate can even be changed during acceleration or deceleration.)
- \*5 SPED (Continuous) to ACC (Continuous) or ACC (Continuous) to ACC (Continuous)
  - The frequency can be changed. (The target frequency can even be changed during acceleration or deceleration.)
  - The acceleration/deceleration rate can be changed. (The rate can even be changed during acceleration or deceleration.)
- \*6 ACC (Independent) to PLS2
  - The number of output pulses can be changed. (The setting can even be changed during acceleration or deceleration.)
  - The frequency can be changed. (The target frequency can even be changed during acceleration or deceleration.)
  - The acceleration/deceleration rate can be changed. (The rate can even be changed during acceleration or deceleration.)
- \*7 ACC (Continuous) to PLS2
  - The frequency can be changed. (The target frequency can even be changed during acceleration or deceleration.)
  - The acceleration/deceleration rate can be changed. (The rate can even be changed during acceleration or deceleration.)
- \*8 PLS2 to PLS2
  - The number of output pulses can be changed. (The setting can even be changed during acceleration or deceleration.)
  - The frequency can be changed. (The target frequency can even be changed during acceleration or deceleration.)
  - The acceleration/deceleration rate can be changed. (The rate can even be changed during acceleration or deceleration.)

## Origin Search Error Processing

The CP1E CPU Unit's pulse output function performs a basic error check before starting to output pulses (when the instruction is executed) and will not output pulses if the settings are incorrect.

There are other errors that can occur with the origin search function during pulse output, which may stop the pulse output.

If an error occurs that stops pulse output, the pulse output's Output Stopped Error Flag will be turned ON and the Pulse Output Stop Error Code will be written to Error Code word. Use these flags and error codes to identify the cause of the error.

The Pulse Output Stop Errors will not affect the CPU Unit's operating status. (The Pulse Output Stop Errors do not cause a fatal or non-fatal error in the CPU Unit.)

## ● Related Auxiliary Area Flags

Function	Settings	Pulse output 0	Pulse output 1
Output Stopped Error Flags ON when an error occurred while outputting pulses in the origin search function.	0: No error 1: Stop error occurred.	A280.07	A281.07
Stop Error Codes When a Pulse Output Stop Error occurs, the error code is stored in that pulse outputs corresponding Stop Error Code word.		A444	A445

## ● Pulse Output Stop Error Codes

Error name	Error code	Likely cause	Corrective action	Operation after error
CW Limit Stop Input Signal	0100	Stopped due to a CW limit signal input.	Move in the CCW direction.	Immediate stop No effect on other port
CCW Limit Stop Input Signal	0101	Stopped due to a CCW limit signal input.	Move in the CW direction.	No effect on other port
No Origin Proximity Input Signal	0200	The parameters indicate that the Origin Proximity Input Signal is being used, but a Origin Proximity Input Signal was not received during the origin search.	Check the wiring of the Origin Proximity Input Signal as well as the PLC Setup's Origin Proximity Input Signal Type setting (NC or NO) and execute the origin search again.	No effect on other port
No Origin Input Signal	0201	The Origin Input Signal was not received during the origin search.	Check the wiring of the Origin Input Signal as well as the PLC Setup's Origin Input Signal Type setting (NC or NO) and execute the origin search again.	No effect on other port
Origin Input Signal Error	0202	During an origin search in operating mode 0, the Origin Input Signal was received during the deceleration started after the Origin Proximity Input Signal was received.	Take one or both of the following steps so that the Origin Input Signal is received after deceleration is completed. <ul style="list-style-type: none"> <li>• Increase the distance between the Origin Proximity Input Signal sensor and Origin Input Signal sensor.</li> <li>• Decrease the origin search high speed.</li> </ul>	Decelerates to a stop. No effect on other port
Limit Inputs in Both Directions	0203	The origin search cannot be performed because the limit signals for both directions are being input simultaneously.	Check the wiring of the limit signals in both directions as well as the PLC Setup's Limit Signal Type setting (NC or NO) and execute the origin search again.	Operation will not start. No effect on other port
Simultaneous Origin Proximity and Limit Inputs	0204	The Origin Proximity Input Signal and the Limit Input Signal in the search direction are being input simultaneously during an origin search.	Check the wiring of the Origin Proximity Input Signal and the Limit Input Signal. Also check the PLC Setup's Origin Proximity Input Signal Type and Limit Signal Type settings (NC or NO) and then execute the origin search again.	Immediate stop No effect on other port
Limit Input Signal Already Being Input	0205	<ul style="list-style-type: none"> <li>• When an origin search in one direction is being performed, the Limit Input Signal is already being input in the origin search direction.</li> <li>• When a non-regional origin search is being performed, the Origin Input Signal and the Limit Input Signal in the opposite direction (from the search direction) are being input simultaneously.</li> </ul>	Check the wiring of the Limit Input Signal and the PLC Setup's I/O settings. Also check the PLC Setup's Limit Signal Type setting (NC or NO) and then execute the origin search again.	Immediate stop No effect on other port

Error name	Error code	Likely cause	Corrective action	Operation after error
Origin Proximity Input Signal Origin Reverse Error	0206	<ul style="list-style-type: none"> <li>• When an origin search with reversal at the limit is being performed, the Limit Input Signal in the search direction was input while the Origin Proximity Input Signal was reversing.</li> <li>• When an origin search with reversal at the limit is being performed and the Origin Proximity Input Signal is not being used, the Limit Input Signal in the search direction was input while the Origin Input Signal was reversing.</li> </ul>	Check the installation positions of the Origin Proximity Input Signal, Origin Input Signal, and Limit Input Signal as well as the PLC Setup's I/O settings. Also check the PLC Setup's Signal Type settings (NC or NO) for each input signal and then execute the origin search again.	Immediate stop No effect on other port
Positioning Timeout Error	0300	The Servo Drive's Positioning Completed Signal does not come ON within the Positioning Monitor Time specified in the PLC Setup.	Adjust the Positioning Monitor Time setting or Servo system gain setting. Check the Positioning Completed Signal wiring, correct it if necessary, and then execute the origin search again.	No effect on other port

## 12-9 Pulse Output Pattern

The CP1E CPU Unit's pulse output function enables operation in Continuous Mode, for which the number of output pulses is not specified, or in Independent Mode, for which the number of output pulses is specified. Continuous Mode is used for speed control and Independent Mode is used for positioning.

### 12-9-1 Speed Control (Continuous Mode)

The following operations can be performed in Continuous Mode by combining instructions.

#### Starting a Pulse Output

Operation	Example application	Frequency changes	Description	Procedure	
				Instruction	Settings
Output with specified speed	Changing the speed (frequency) in one step		Outputs pulses at a specified frequency.	SPED (Continuous)	<ul style="list-style-type: none"> <li>Port</li> <li>Pulse + direction</li> <li>Continuous</li> <li>Target frequency</li> </ul>
Output with specified acceleration and speed	Accelerating the speed (frequency) at a fixed rate		Outputs pulses and changes the frequency at a fixed rate.	ACC (Continuous)	<ul style="list-style-type: none"> <li>Port</li> <li>Pulse + direction</li> <li>Continuous</li> <li>Acceleration/deceleration rate</li> <li>Target frequency</li> </ul>

#### Changing Settings

Operation	Example application	Frequency changes	Description	Procedure	
				Instruction	Settings
Change speed in one step	Changing the speed during operation		Changes the frequency (higher or lower) of the pulse output in one step.	SPED (Continuous) ↓ SPED (Continuous)	<ul style="list-style-type: none"> <li>Port</li> <li>Continuous</li> <li>Target frequency</li> </ul>
Change speed smoothly	Changing the speed smoothly during operation		Changes the frequency from the present frequency at a fixed rate. The frequency can be accelerated or decelerated.	ACC or SPED (Continuous) ↓ ACC (Continuous)	<ul style="list-style-type: none"> <li>Port</li> <li>Continuous</li> <li>Target frequency</li> <li>Acceleration/deceleration rate</li> </ul>

Operation	Example application	Frequency changes	Description	Procedure	
				Instruction	Settings
	Changing the speed in a polyline curve during operation	<p>The graph shows pulse frequency on the y-axis and time on the x-axis. A horizontal line represents the present frequency. A dashed line represents the target frequency. The frequency increases from the present to the target through three stages: Acceleration/deceleration rate 1, Acceleration/deceleration rate 2, and Acceleration/deceleration rate n. Vertical arrows indicate the execution of ACC instructions at the start of each rate stage.</p>	Changes the acceleration or deceleration rate during acceleration or deceleration.	ACC (Continuous) ↓ ACC (Continuous)	<ul style="list-style-type: none"> <li>• Port</li> <li>• Continuous</li> <li>• Target frequency</li> <li>• Acceleration/ deceleration rate</li> </ul>
Change direction	Not supported.				

## Stopping a Pulse Output

Operation	Example application	Frequency changes	Description	Procedure	
				Instruction	Settings
Stop pulse output	Immediate stop	<p>The graph shows pulse frequency on the y-axis and time on the x-axis. A horizontal line represents the present frequency. At a certain point, the frequency drops abruptly to zero. A vertical arrow labeled 'Execution of INI' points to this drop.</p>	Stops the pulse output immediately.	SPED or ACC (Continuous) ↓ INI	<ul style="list-style-type: none"> <li>• Port</li> <li>• Stop pulse output</li> </ul>
Stop pulse output	Immediate stop	<p>The graph shows pulse frequency on the y-axis and time on the x-axis. A horizontal line represents the present frequency. At a certain point, the frequency drops abruptly to zero. A vertical arrow labeled 'Execution of SPED' points to this drop.</p>	Stops the pulse output immediately.	SPED ↓ SPED (Continuous)	<ul style="list-style-type: none"> <li>• Port</li> <li>• Continuous</li> <li>• Target frequency=0</li> </ul>
Stop pulse output smoothly	Decelerate to a stop	<p>The graph shows pulse frequency on the y-axis and time on the x-axis. A horizontal line represents the present frequency. A dashed line represents the target frequency=0. The frequency decreases linearly from the present to the target. A vertical arrow labeled 'Execution of ACC' points to the start of this deceleration. A label 'Acceleration/deceleration rate (Rate set at the start of the operation.)' points to the slope of the line.</p>	Decelerates the pulse output to a stop.*	SPED or ACC (Continuous) ↓ ACC (Continuous)	<ul style="list-style-type: none"> <li>• Port</li> <li>• Continuous</li> <li>• Target frequency=0</li> </ul>

\* If an ACC instruction started the operation, the original acceleration/deceleration rate will remain in effect. If a SPED instruction started the operation, the acceleration/deceleration rate will be invalid and the pulse output will stop immediately.

## 12-9-2 Positioning Control (Independent Mode)

The following operations can be performed in Independent Mode by combining instructions.

### Starting a Pulse Output

Operation	Example application	Frequency changes	Description	Procedure	
				Instruction	Settings
Output with specified speed	Positioning without acceleration or deceleration		<p>Starts outputting pulses at the specified frequency and stops immediately when the specified number of pulses has been output.</p> <p>The target position (specified number of pulses) cannot be changed during positioning.</p>	<p>PULS</p> <p>↓</p> <p>SPED (Independent)</p>	<ul style="list-style-type: none"> <li>• Number of pulses</li> <li>• Relative or absolute pulse specification</li> <li>• Port</li> <li>• Pulse + Direction</li> <li>• Independent</li> <li>• Target frequency</li> </ul>
Simple trapezoidal control	Positioning with trapezoidal acceleration and deceleration (Same rate used for acceleration and deceleration; no starting speed). The number of pulses cannot be changed during positioning.		<p>Accelerates and decelerates at the same fixed rate and stops immediately when the specified number of pulses has been output.*</p>	<p>PULS</p> <p>↓</p> <p>ACC (Independent)</p>	<ul style="list-style-type: none"> <li>• Number of pulses</li> <li>• Relative or absolute pulse specification</li> <li>• Port</li> <li>• Pulse + Direction</li> <li>• Independent</li> <li>• Acceleration and deceleration rate</li> <li>• Target frequency</li> </ul>
Complex trapezoidal control	Positioning with trapezoidal acceleration and deceleration (Separate rates used for acceleration and deceleration; starting speed) The number of pulses can be changed during positioning.		<p>Accelerates and decelerates at a fixed rates. The pulse output is stopped when the specified number of pulses has been output.*</p> <p>The target position (specified number of pulses) can be changed during positioning.</p>	<p>PLS2</p>	<ul style="list-style-type: none"> <li>• Number of pulses</li> <li>• Relative or absolute pulse specification</li> <li>• Port</li> <li>• Pulse + Direction</li> <li>• Acceleration rate</li> <li>• Deceleration rate</li> <li>• Target frequency</li> <li>• Starting frequency</li> </ul>

\* Triangular Control

If the specified number of pulses is less than the number required just to reach the target frequency and return to zero, the function will automatically reduce the acceleration/deceleration time and perform triangular control (acceleration and deceleration only.) An error will not occur.

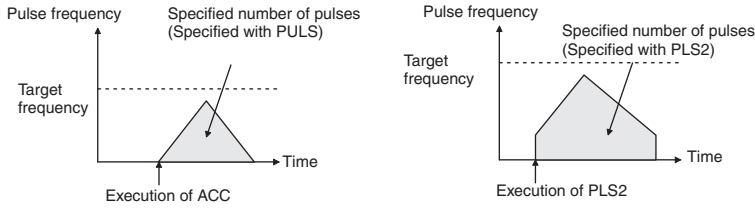

## Changing Settings

Operation	Example application	Frequency changes	Description	Procedure	
				Instruction	Settings
Change speed in one step	Changing the speed in one step during operation	<p>Execution of SPED (independent mode) SPED (independent mode) executed again to change the target frequency. (The target position is not changed.)</p>	SPED can be executed during positioning to change (raise or lower) the pulse output frequency in one step. The target position (specified number of pulses) is not changed.	PULS ↓ SPED (Independent) ↓ SPED (Independent)	<ul style="list-style-type: none"> <li>• Number of pulses</li> <li>• Relative or absolute pulse specification</li> <li>• Port</li> <li>• Pulse + Direction</li> <li>• Independent</li> <li>• Target frequency</li> </ul>
Change speed smoothly (with acceleration rate = deceleration rate)	Changing the target speed (frequency) during positioning (acceleration rate = deceleration rate)	<p>Execution of ACC (independent mode) ACC (independent mode) executed again to change the target frequency. (The target position is not changed, but the acceleration/deceleration rate is changed.)</p>	ACC can be executed during positioning to change the acceleration/deceleration rate and target frequency. The target position (specified number of pulses) is not changed.	PULS ↓ ACC (Independent) ↓ ACC (Independent) ↓ PLS2 ↓ ACC (Independent)	<ul style="list-style-type: none"> <li>• Number of pulses</li> <li>• Relative or absolute pulse specification</li> <li>• Port</li> <li>• Pulse + Direction</li> <li>• Independent</li> <li>• Acceleration/deceleration rate</li> <li>• Target frequency</li> </ul>



Operation	Example application	Frequency changes	Description	Procedure	
				Instruction	Settings
Change speed smoothly (with unequal acceleration and deceleration rates)	Changing the target speed (frequency) during positioning (different acceleration and deceleration rates)		<p>PLS2 can be executed during positioning to change the acceleration rate, deceleration rate, and target frequency.</p> <p>To prevent the target position from being changed intentionally, the original target position must be specified in absolute coordinates.</p>	PULS ↓ ACC (Independent) ↓ PLS2	<ul style="list-style-type: none"> <li>• Number of pulses</li> <li>• Relative or absolute pulse specification</li> <li>• Port</li> <li>• Pulse + Direction</li> <li>• Acceleration rate</li> <li>• Deceleration rate</li> <li>• Target frequency</li> <li>• Starting frequency</li> </ul>
Change target position	Change the target position during positioning (multiple start function)		<p>PLS2 can be executed during positioning to change the target position (number of pulses).</p> <p>When the target position cannot be changed without maintaining the same speed range, an error will occur and the original operation will continue to the original target position.</p>	PULS ↓ ACC (Independent) ↓ PLS2	<ul style="list-style-type: none"> <li>• Number of pulses</li> <li>• Relative or absolute pulse specification</li> <li>• Port</li> <li>• Pulse + Direction</li> <li>• Acceleration rate</li> <li>• Deceleration rate</li> <li>• Target frequency</li> <li>• Starting frequency</li> </ul>

Operation	Example application	Frequency changes	Description	Procedure	
				Instruction	Settings
Change target position and speed smoothly	Change the target position and target speed (frequency) during positioning (multiple start function)		<p>PLS2 can be executed during positioning to change the target position (number of pulses), acceleration rate, deceleration rate, and target frequency.</p> <p>When the settings cannot be changed without maintaining the same speed range, an error will occur and the original operation will continue to the original target position.</p>	PULS ↓ ACC (Independent) ↓ PLS2	<ul style="list-style-type: none"> <li>• Number of pulses</li> <li>• Relative or absolute pulse specification</li> <li>• Port</li> <li>• Pulse + Direction</li> <li>• Acceleration rate</li> <li>• Deceleration rate</li> <li>• Target frequency</li> <li>• Starting frequency</li> </ul>
	Change the acceleration and deceleration rates during positioning (multiple start function)		<p>PLS2 can be executed during positioning (acceleration or deceleration) to change the acceleration rate or deceleration rate.</p>	PLS2 ↓ PLS2	<ul style="list-style-type: none"> <li>• Number of pulses</li> <li>• Acceleration rate</li> <li>• Deceleration rate</li> </ul>
Change direction	Change the direction during positioning		<p>PLS2 can be executed during positioning with absolute pulse specification to change to absolute pulses and reverse direction.</p>	PULS ↓ ACC (Independent) ↓ PLS2 ↓ PLS2	<ul style="list-style-type: none"> <li>• Number of pulses</li> <li>• Absolute pulse specification</li> <li>• Port</li> <li>• Pulse + Direction</li> <li>• Acceleration rate</li> <li>• Deceleration rate</li> <li>• Target frequency</li> <li>• Starting frequency</li> </ul>

## Stopping a Pulse Output

Operation	Example application	Frequency changes	Description	Procedure	
				Instruction	Settings
Stop pulse output (Number of pulses setting is not preserved.)	Immediate stop		Stops the pulse output immediately and clears the number of output pulses setting.	PULS ↓ ACC or SPED (Independent) ↓ INI PLS2 ↓ INI	Stop pulse output
Stop pulse output (Number of pulses setting is not preserved.)	Immediate stop		Stops the pulse output immediately and clears the number of output pulses setting.	PULS ↓ SPED (Independent) ↓ SPED (Independent)	<ul style="list-style-type: none"> <li>• Port</li> <li>• Independent</li> <li>• Target frequency = 0</li> </ul>
Stop sloped pulse output smoothly. (Number of pulses setting is not preserved.)	Decelerate to a stop		Decelerates the pulse output to a stop. If ACC started the operation, the original acceleration/deceleration rate will remain in effect. If SPED started the operation, the acceleration/deceleration rate will be invalid and the pulse output will stop immediately.	PULS ↓ ACC or SPED (Independent) ↓ ACC (Independent) PLS2 ↓ ACC (Independent)	<ul style="list-style-type: none"> <li>• Port</li> <li>• Independent</li> <li>• Target frequency = 0</li> </ul>

## Switching from Speed Control (Continuous Mode) to Positioning (Independent Mode)

Example application	Frequency changes	Description	Procedure	
			Instruction	Settings
Change from speed control to fixed distance positioning during operation	<p>Outputs the number of pulses specified in PLS2 (Both relative and absolute pulse specification can be used.)</p>	<p>PLS2 can be executed during a speed control operation started with ACC to change to positioning operation.</p> <p>An error will occur if a constant speed cannot be achieved after switching the mode. If this happens, the instruction execution will be ignored and the previous operation will be continued.</p>	<p>ACC (Continuous) ↓ PLS2</p>	<ul style="list-style-type: none"> <li>• Port</li> <li>• Acceleration rate</li> <li>• Deceleration rate</li> <li>• Target frequency*</li> <li>• Number of pulses</li> </ul>
Fixed distance feed interrupt	<p>Execution of PLS2 with the following settings</p> <ul style="list-style-type: none"> <li>• Number of pulses = number of pulses until stop</li> <li>• Relative pulse specification</li> <li>• Target frequency = present frequency</li> <li>• Acceleration rate = Not 0</li> <li>• Deceleration rate = target deceleration rate</li> </ul>			

\* The starting frequency is ignored.

# 13

## PWM Outputs

This section describes the PWM Outputs (variable-duty-factor pulse outputs).

---

<b>13-1 PWM Outputs (Variable-duty-factor Pulse Outputs)</b> .....	<b>13-2</b>
13-1-1 Flow of Operation .....	13-3
13-1-2 Ladder Program Example.....	13-4

# 13-1 PWM Outputs (Variable-duty-factor Pulse Outputs)

PWM outputs can be used only with the CP1E N/NA□□(S)-type CPU Unit with transistor outputs.

A PWM (Pulse Width Modulation) pulse can be output with a specified duty factor. The duty factor is the ratio of the pulse's ON time and OFF time in one pulse cycle. Use the PWM instruction to generate PWM pulses from a built-in output. The duty factor can be changed during pulse output.

## ● Application example

- Controlling temperature on a time-proportional basis using the PWM output.
- Controlling the brightness of lighting.

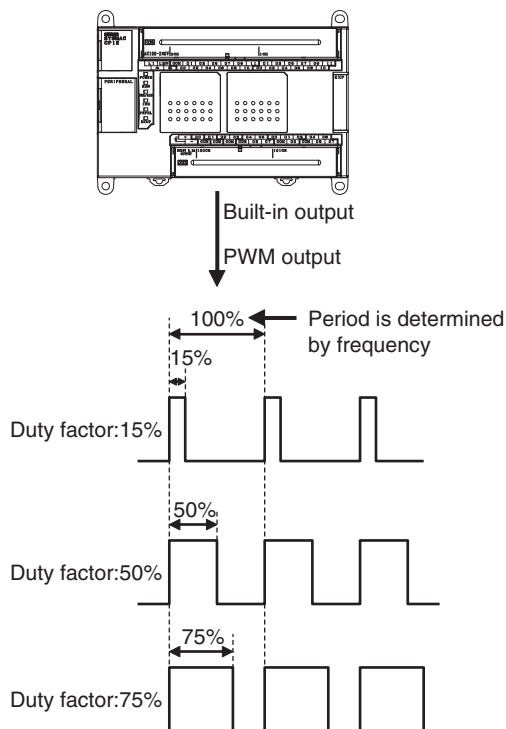

## Specifications

Item	Specification
Duty factor	0.0% to 100.0% in 0.1% increments (Duty factor accuracy is +1%/-0% at 10 kHz, +5%/-0% at 10 to 32 kHz.)
Frequency	2.0 Hz to 6,553.5 Hz (Set in 0.1-Hz increments.)* 2 Hz to 32,000 Hz (Set in 1-Hz increments.)*
Output mode	Continuous mode
Instruction	PWM

\* The duty factor accuracy declines significantly at high frequencies because of limitations in the output circuit at high frequencies.



### Additional Information

For N30/40/60(S□) or NA20 CPU Units, the output indicator of terminal 01 on terminal block CIO100 is always lit during PWM output.

## Wiring for N□□S(1)-type CPU Unit

An external power supply is required for N□□S(1)-type CPU Units when using the PWM output. Provide a DC24V external power supply to V+ and V- terminals as follows.

### ● Wiring Example

Sinking outputs

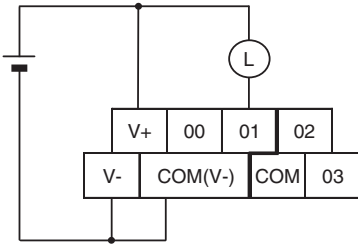

Although V- and COM(V-) are connected internally, also wire them externally.

Sourcing outputs

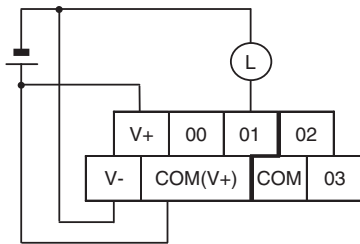

Although V+ and COM(V+) are connected internally, also wire them externally.

Do not connect an external power supply to N□□-type CPU Units.

## 13-1-1 Flow of Operation

- 1 Setting pulse output port number, assigning pulse output terminals, and wiring. Terminal 01 on terminal block CIO100 is used for PWM output 0.
- 2 Greate ladder program Cyclic task, interrupt task.
  - The PWM instruction is used to control PWM outputs.
  - PWM outputs are stopped with the INI instruction.

### ● Pulse Output Port Number and Pulse Output Terminals

The following terminals can be used for pulse outputs according to the pulse output method.

Output terminal block		Specifications made with PWM instruction	Other functions that cannot be used at the same time	
Terminal block label	Terminal number		Pulse output method	
			Pulse + direction	Normal output
CIO 100	00	–	Pulse output 0, pulse	Normal output 0
	01	PWM output 0	Pulse output 1, pulse	Normal output 1
	02	–	Pulse output 0, direction	Normal output 2
	03	–	Pulse output 1, direction	Normal output 3

## 13-1-2 Ladder Program Example

### Specifications and Operation

When the start input (CIO 0.00) turns ON in this example, pulses with a duty factor of 40% at a frequency of 2,000 Hz are output from PWM output 0. When the stop input (CIO 0.01) turns ON, PWM output 0 is stopped.

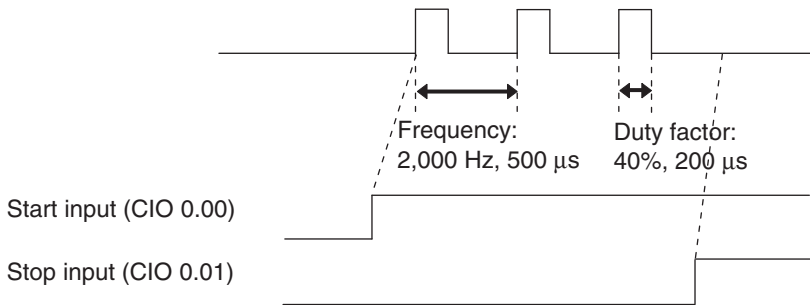

### Applicable Instructions

PWM  
INI

### Preparations

#### ● PLC Setup

There are no settings that need to be made in the PLC Setup.

#### ● DM Area Settings

- PWM Operand Settings (D0 and D1)

Setting	Operand	Data
Frequency: 2,000.0 Hz	D0	#4E20
Duty factor: 40.0%	D1	#0190

#### ● Ladder Diagram

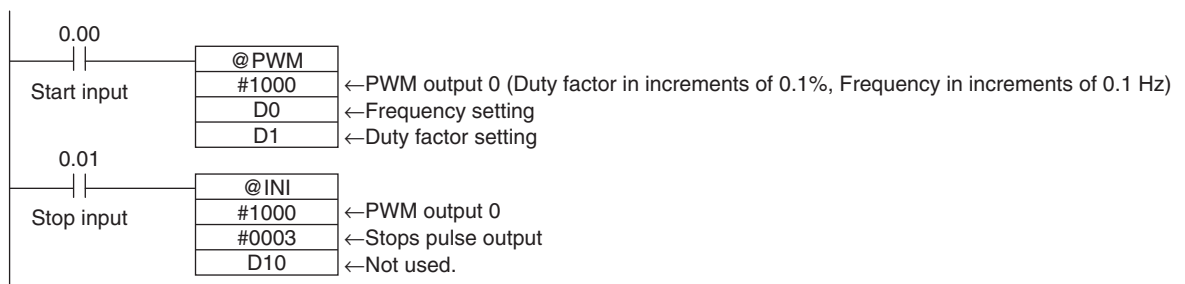



# 14

## Serial Communications

This section describes communications with Programmable Terminals (PTs) without using communications programming, no-protocol communications with general components, and connections with a Modbus-RTU Easy Master, Serial PLC Link, and host computer.

---

<b>14-1 Serial Communications</b> .....	<b>14-2</b>
14-1-1 Types of CPU Units and Serial Ports .....	14-2
14-1-2 Overview of Serial Communications .....	14-3
<b>14-2 Program-free Communications with Programmable Terminals</b> .....	<b>14-5</b>
14-2-1 Overview .....	14-5
14-2-2 Flow of Connection .....	14-6
14-2-3 PLC Setup and PT System Settings .....	14-6
<b>14-3 No-protocol Communications with General Components</b> .....	<b>14-8</b>
14-3-1 Overview .....	14-8
14-3-2 Flow of Operation .....	14-9
14-3-3 PLC Setup .....	14-9
14-3-4 Related Auxiliary Area Bits and Words .....	14-10
<b>14-4 Modbus-RTU Easy Master Function</b> .....	<b>14-11</b>
14-4-1 Overview .....	14-11
14-4-2 Flow of Operation .....	14-11
14-4-3 Setting and Word Allocation .....	14-12
14-4-4 Programming Examples .....	14-14
<b>14-5 Serial PLC Links</b> .....	<b>14-20</b>
14-5-1 Overview .....	14-20
14-5-2 Flow of Operation .....	14-21
14-5-3 PLC Setup .....	14-21
14-5-4 Operating Specifications .....	14-23
14-5-5 Example Application .....	14-29
<b>14-6 Connecting the Host Computer</b> .....	<b>14-31</b>
14-6-1 Overview .....	14-31
14-6-2 Flow of Operation .....	14-31
14-6-3 Command/response Format and List of Commands .....	14-32
<b>14-7 Precautions on the usage of RS-485</b> .....	<b>14-34</b>

# 14-1 Serial Communications

Serial communications can be used only with the CP1E N/NA□□(S)-type CPU Unit.

## 14-1-1 Types of CPU Units and Serial Ports

### ● N/NA□□(S)-type CPU Unit

- N14/20 or N30/40/60S CPU Units have one built-in RS-232C port. There are no option slots.
- N30/40/60 or NA20 CPU Units have one built-in RS-232C port and one option slot. An RS-232C or RS-422A/485 Option Board can be mounted for serial communications.
- N30/40/60S1 CPU Units have one built-in RS-232C port and one built-in RS-485 port. There are no option slots.

### ● E□□(S)-type CPU Unit

There is no serial port.

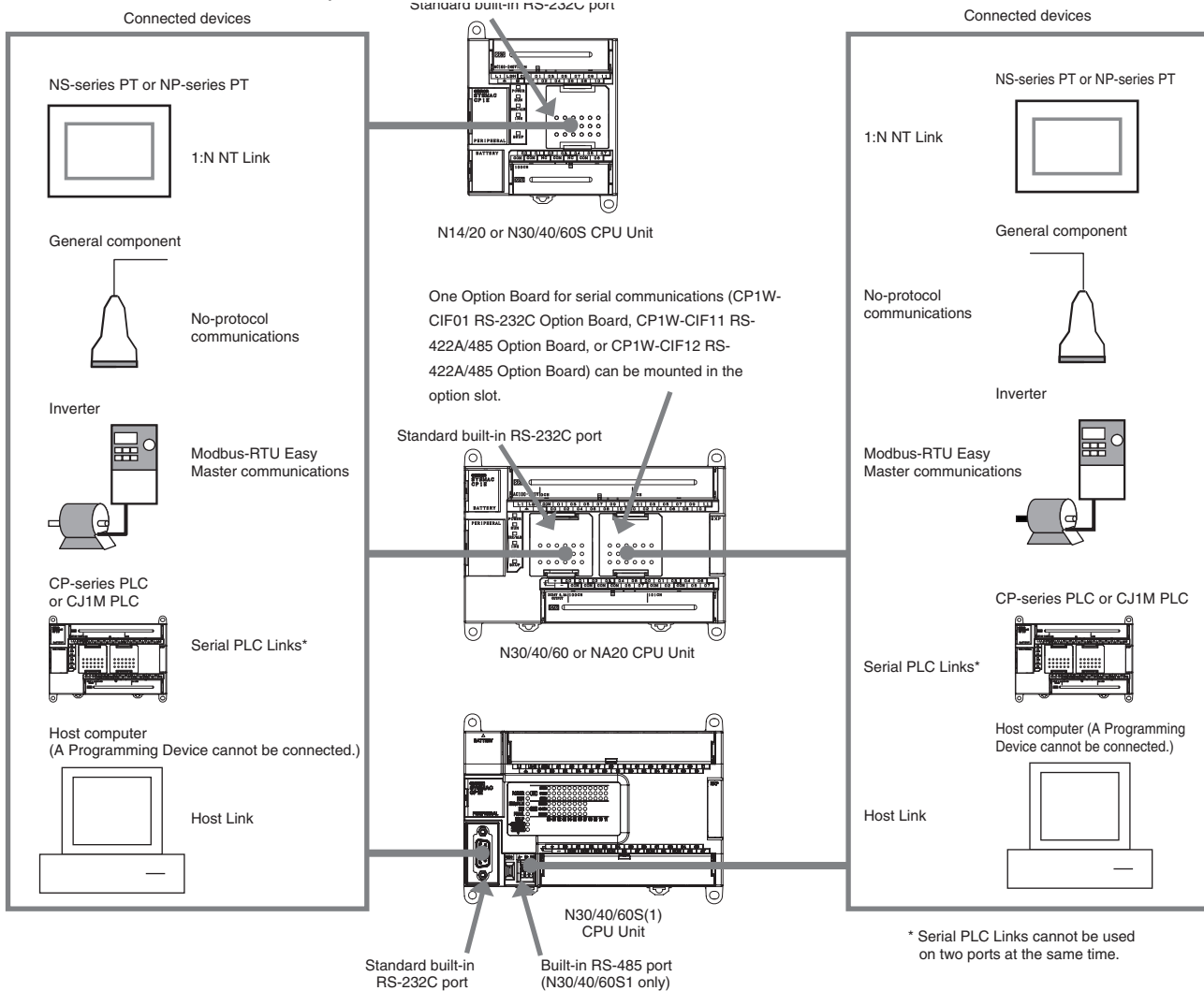

## 14-1-2 Overview of Serial Communications

The CP1E CPU Units support the following types of serial communications.

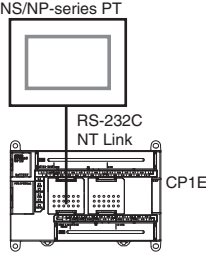
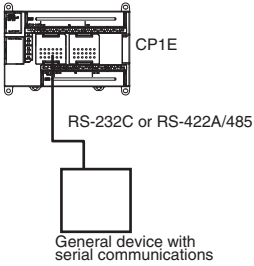
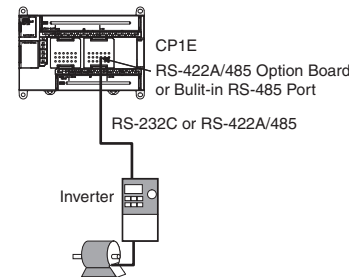
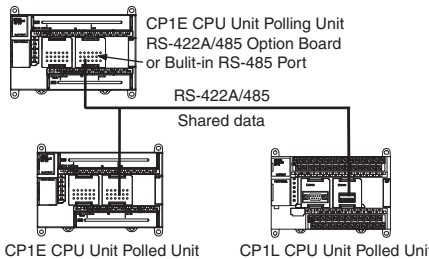
Connected devices	Description	Communications protocol	Built-in RS-232C	Optional serial port or built-in RS-485
<p>Programmable Terminal</p> 	<p>Data can be exchanged with PTs without using a communications program in the CPU Unit.</p> <p><b>Note</b> Only one PT can be connected when using a 1:N NT Link. It is not possible to connect two PTs.</p>	<p>1:N NT Links (Host Link is also supported.)</p>	<p>OK</p>	<p>OK</p>
<p>General component</p> 	<p>Communicates with general devices, such as barcode readers, with an RS-232C or RS-422A/485 port without a command-response format. The TXD and RXD instructions are executed in the ladder program in the CPU Unit to transmit data from the transmission port or read data in the reception port.</p>	<p>No-protocol communications</p>	<p>OK</p>	<p>OK</p>
<p>Modbus-RTU slave devices, such as inverters (Modbus-RTU Easy Master)</p> 	<p>Data can be easily exchanged with general devices that support Modbus-RTU slave functionality (such as inverters) and are equipped with an RS-232C port or RS-422A/485 port.</p>	<p>Modbus-RTU Easy Master Function</p>	<p>OK</p>	<p>OK</p>
<p>Data links between CPU Units</p> 	<p>Data links can be created for up to nine CP-series or CJ1M CPU Units, including one Polling Unit and up to eight Polled Units. Up to 10 words can be shared per Unit.*</p>	<p>Serial PLC Links</p>	<p>OK</p>	<p>OK</p>

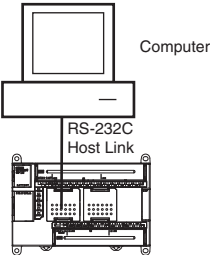
Connected devices	Description	Communications protocol	Built-in RS-232C	Optional serial port or built-in RS-485
<p>Host computers</p>  <p>The diagram shows a computer monitor and keyboard connected to a PLC unit. A line labeled 'RS-232C Host Link' connects the computer to the PLC.</p>	<p>PLC data can be read by the host computer or written to the PLC from the computer. The host computer sends a Host Link command (C Mode) or a FINS command to the CPU Unit to read/write I/O memory, change the operating mode, or to force-set/reset bits in the CPU Unit.</p>	<p>Host Link</p>	<p>OK</p>	<p>OK</p>

\* A PT cannot be included in the Serial PLC Links.

**Note** Built-in RS-485 on N□□S(1)-type CPU Units can only communicate in half duplex.



**Additional Information**

Refer to *A-3 Wiring for Serial Communications* in the *CP1E CPU Unit Hardware User's Manual* (Cat.No.W479) for Serial communication wiring.

# 14-2 Program-free Communications with Programmable Terminals

Programmable Terminal communications can be used only with the CP1E N/NA□□(S)-type CPU Unit.

## 14-2-1 Overview

Communications without special communications programming is possible between a CP1E CPU Unit and a Programmable Terminal (PT) by using the 1:N NT Link protocol.

Connect the serial port of the CP1E CPU Unit and PT with NT Link (1:N) communication mode, and connect the CP1E CPU Unit and PT 1:1 as shown below.

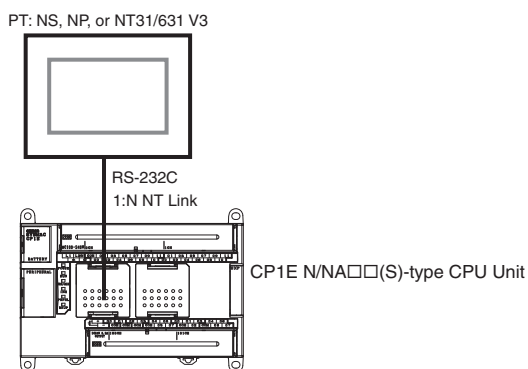

### ● Connectable Programmable Terminals (PTs)

High-speed NT Links (115,200 bps) can be used with NS-series, NP-series, or NT-series PTs.



#### Precautions for Correct Use

- Communications are not possible for CP1E CPU Units using the 1:1 NT Link protocol. Do not connect more than one PT to a CP1E CPU Unit even if the 1:N NT Link protocol is used.
- SAP (Smart Active Parts) on NS-series PTs cannot be used for CP1E CPU Units.
- The main unit of NT31/31C/631/631C cannot be connected with NT Link for the system programs preinstalled prior to Ver.1 and system programs in Chinese (Simplified and Traditional) version and Korean version. Connect with Host Link.

### 14-2-2 Flow of Connection

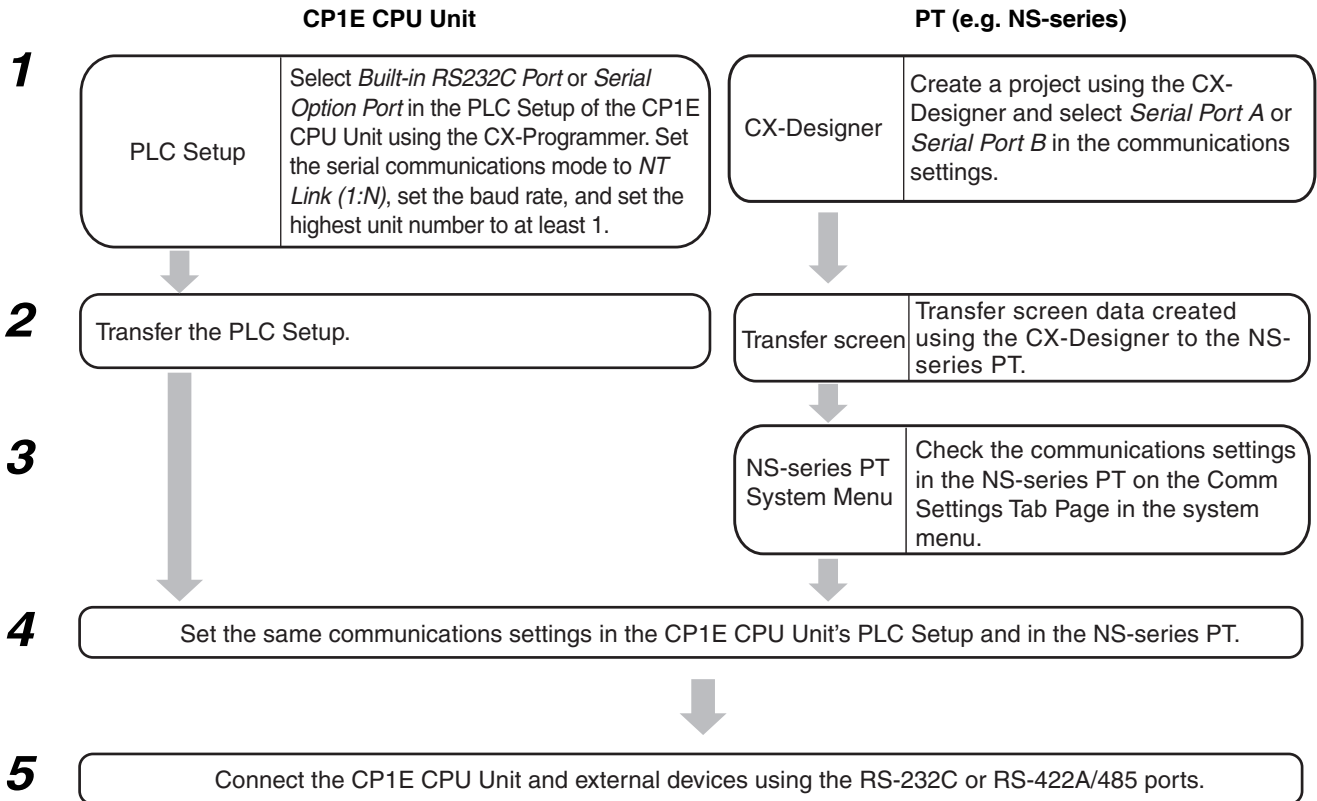

### 14-2-3 PLC Setup and PT System Settings

Set the parameters in the PLC Setup and the PT's System Menu.

#### PLC Setup

Click the **Built-in RS232C Port** or **Serial Option Port** Tab in the PLC Settings Dialog Box.

**Note** The built-in RS-485 port of the N□□S1-type CPU Unit should be set in the **Serial Option Port** tab.

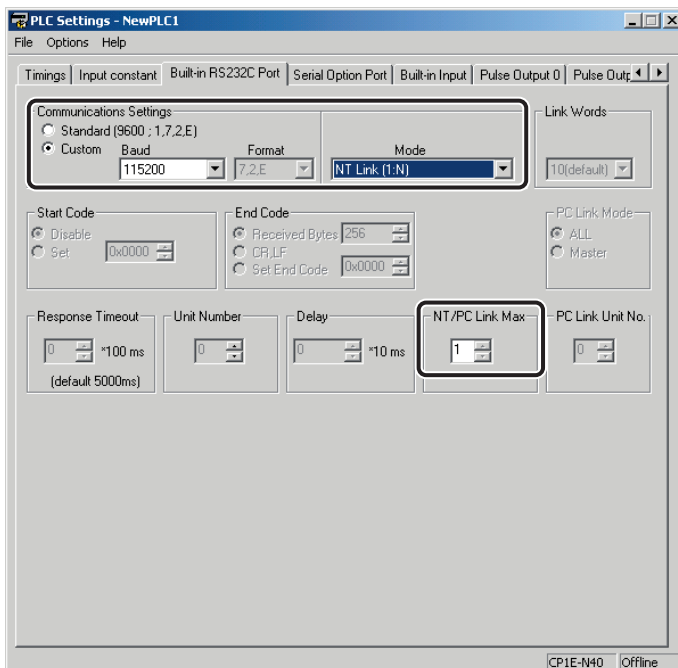

## Built-in RS232C Port or Serial Option Port Tab Page

Parameter	Setting
Communications Settings	Select the <i>Custom</i> Option and set the baud rate to 115,200 (same as the 1:N NT Link High-speed Mode). It is not necessary to change the format setting.
Mode	Select <i>NT Link (1:N)</i> .
NT/PC Link Max.	If only one NS-series PT (unit number 0) is connected, set this parameter to 1. In any other case of NS-series PTs, select the unit number (1 to 7) of the connected NS-series PT. In case of NP and NT-series PTs, select the unit number (0 to 7) of the connected NP and NT-series PT.

## PT System Menu

Set the PT as follows:

Example: NS-series PT

- 1** Select **NT Links (1:N)** from Serial Port A or Serial Port B on the Memory Switch Menu under the System Menu on the PT.
- 2** Press the **SET** Touch Switch to set the baud rate to high speed. (A baud rate of 115,200 bps in the PLC Setup is the same as setting high speed for the PT.)

## Connection with Other Company's Display Devices

Select **Host Link** in the serial communications mode settings of the CP1E N/NA□□(S)-type CPU Unit and set all other communications parameters to the same values as the other company's display device.

# 14-3 No-protocol Communications with General Components

No-protocol communications can be used only with the CP1E N/NA□□(S)-type CPU Unit.

## 14-3-1 Overview

CP1E CPU Units and general devices with serial communications ports can be used for no-protocol communications.

No-protocol communications enable sending and receiving data using the TRANSMIT (TXD) and RECEIVE (RXD) instructions without using a protocol and without data conversion (e.g., no retry processing, data type conversion, or process branching based on received data).

The serial communications mode is set to RS-232C.

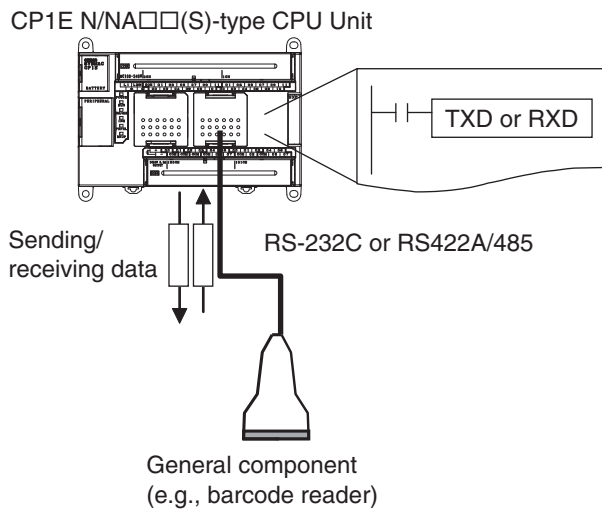

No-protocol communications are used to send data in one direction to or from general external devices that have an RS-232C or RS-422A/485 port using TXD or RXD.

For example, simple (no-protocol) communications can be used to input data from a barcode reader or output data to a printer.

The following table lists the no-protocol communication functions supported by CP1E PLCs.

Communications	Transfer direction	Method	Max. amount of data	Frame format		Other functions
				Start code	End code	
Data transmission	PLC → External device	Execution of TXD in the ladder program	256 bytes	Yes: 00 to FF hex No: None	Yes: 00 to FF hex or CR+LF No: None (The amount of data to receive is specified between 1 and 256 bytes when no end code is specified.)	<ul style="list-style-type: none"> <li>Send delay time (delay between TXD execution and sending data from specified port): 0 to 99,990 ms at the minimum(unit: 10 ms)</li> <li>Controlling RS and ER signals</li> </ul>
Data reception	External device → PLC	Execution of RXD in the ladder program	256 bytes			Monitoring CS and DR signals

**Note 1** Because the built-in RS-485 port of the N□□S1-type CPU Unit uses 2-wire connections, so it can only communicate in half duplex. Communications are not possible in full duplex.

**2** DR and ER signals are not supported by the built-in RS-232C port on the N□□S(1)-type CPU Unit.



### 14-3-2 Flow of Operation

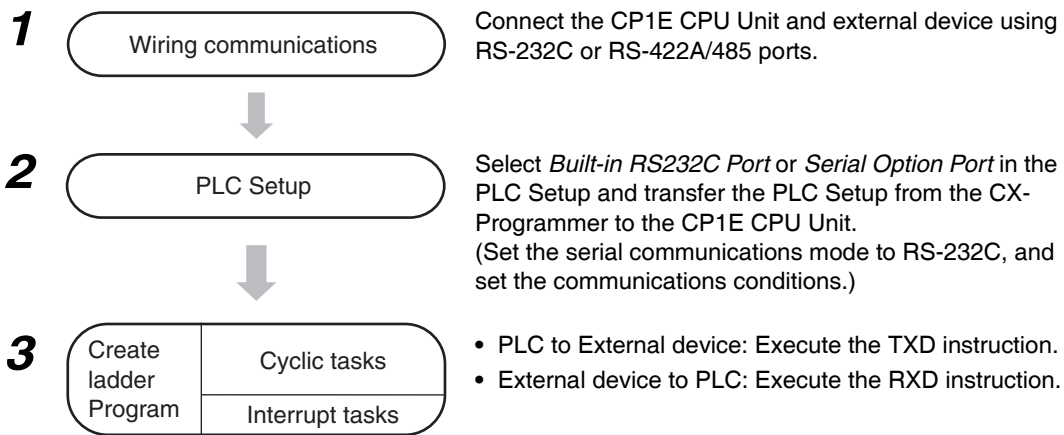

### 14-3-3 PLC Setup

Click the **Built-in RS232C Port** or **Serial Option Port** Tab in the PLC Settings Dialog Box.

**Note** The built-in RS-485 port of the N□□S1-type CPU Unit should be set in the **Serial Option Port** tab.

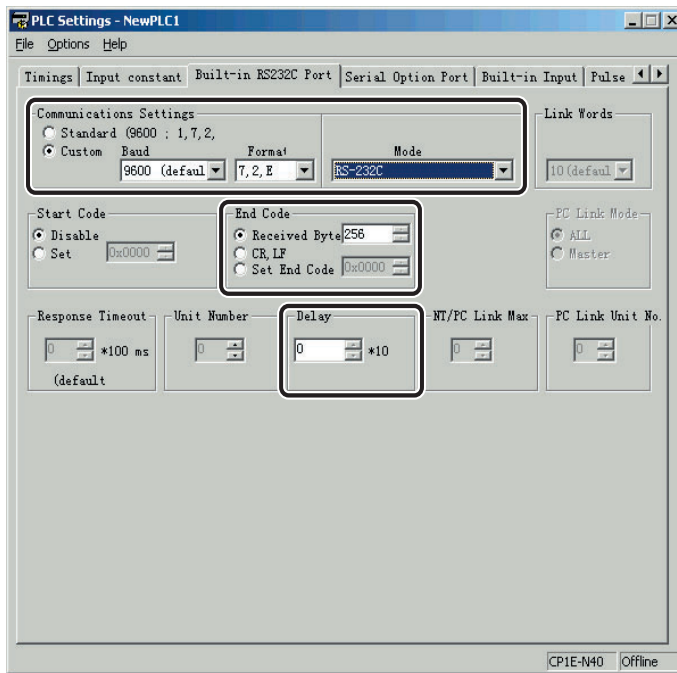

Built-in RS232C Port or Serial Option Port Tab Page

Parameter	Setting
Communications Settings	Set the communications settings to the same values as the connected device. If the connected device is set to 9,600 bps, two stop bits, and even parity, select the <i>Custom</i> Option, set the baud rate to 9,600 and format to 7,2,E.
Mode	Select <i>RS-232C</i> .
End Code	<ul style="list-style-type: none"> <li>• To specify the number of bytes of received data, select <i>Received bytes</i> and set the number of bytes from 1 to 256.</li> <li>• To use CR+LF as the end code, set CR+LF.</li> <li>• To set the end code to any value between 00 to FF hex, set a value between 0x0000 and 0x00FF.</li> </ul>

### 14-3-4 Related Auxiliary Area Bits and Words

Address	Name	Details
A392.04	Built-in RS-232C Port Communications Error Flag	<ul style="list-style-type: none"> <li>• Turns ON when a communications error occurs at the built-in RS-232C port. The port must be restarted when this flag turns ON.</li> <li>• Turns ON when a timeout error, overrun error, framing error, parity error, or BCC error occurs in Modbus-RTU Easy Master Mode.</li> </ul>
A392.05	Built-in RS-232C Port Send Ready Flag (No-protocol mode)	ON when the built-in RS-232C port is able to send data in no-protocol mode.
A392.06	Built-in RS-232C Port Reception Completed Flag (No-protocol mode)	<p>ON when the built-in RS-232C port has completed the reception in no-protocol mode.</p> <ul style="list-style-type: none"> <li>• When the number of bytes was specified: ON when the specified number of bytes is received.</li> <li>• When the end code was specified: ON when the end code is received or 256 bytes are received.</li> </ul>
A392.07	Built-in RS-232C Port Reception Overflow Flag (No-protocol mode)	<p>ON when a data overflow occurred during reception through the built-in RS-232C port in no-protocol mode.</p> <ul style="list-style-type: none"> <li>• When the number of bytes was specified: ON when more data is received after the reception was completed but before RXD was executed.</li> <li>• When the end code was specified: ON when more data is received after the end code was received but before RXD is executed. ON when 257 bytes are received before the end code. If a start code is specified, ON when the end code is received after the start code is received.</li> </ul>
A392.12	Serial Option Port/Built-in RS-485 Port Communications Error Flag	<ul style="list-style-type: none"> <li>• ON when a communications error has occurred at the serial option port or built-in RS-485 port. The port must be restarted when this flag turns ON.</li> <li>• ON when a timeout error, overrun error, framing error, parity error, or BCC error occurs in Modbus-RTU Easy Master mode.</li> </ul>
A392.13	Serial Option Port/Built-in RS-485 Port Send Ready Flag (No-protocol Mode)	ON when the serial option port or built-in RS-485 port is able to send data in no-protocol mode.
A392.14	Serial Option Port/Built-in RS-485 Port Reception Completed Flag (No-protocol Mode)	<p>ON when the serial option port or built-in RS-485 port has completed the reception in no-protocol mode.</p> <ul style="list-style-type: none"> <li>• When the number of bytes was specified: ON when the specified number of bytes is received.</li> <li>• When the end code was specified: ON when the end code is received or 256 bytes are received.</li> </ul>
A392.15	Serial Option Port/Built-in RS-485 Port Reception Overflow Flag (No-protocol Mode)	ON when a data overflow occurred during reception through the serial option port or built-in RS-485 port in no-protocol mode.
A393.00 to A393.15	Built-in RS-232C Port Reception Counter (No-protocol Mode)	<ul style="list-style-type: none"> <li>• Indicates (in binary) the number of bytes of data received when the built-in RS-232C port is in no-protocol mode.</li> <li>• The start code and end code are not included.</li> </ul>
A394.00 to A394.15	Serial Option Port/Built-in RS-485 Port Reception Counter (No-protocol Mode)	<ul style="list-style-type: none"> <li>• Indicates (in binary) the number of bytes of data received when the serial option port or built-in RS-485 port is in no-protocol mode.</li> <li>• The start code and end code are not included.</li> </ul>

# 14-4 Modbus-RTU Easy Master Function

The Modbus-RTU Easy Master Function can be used only with the CP1E N/NA□□(S)-type CPU Unit.

## 14-4-1 Overview

Using the Modbus-RTU Easy Master enables easy control of Modbus-compatible slaves, such as inverters, using serial communications. The serial communications mode is set to Modbus-RTU Easy Master.

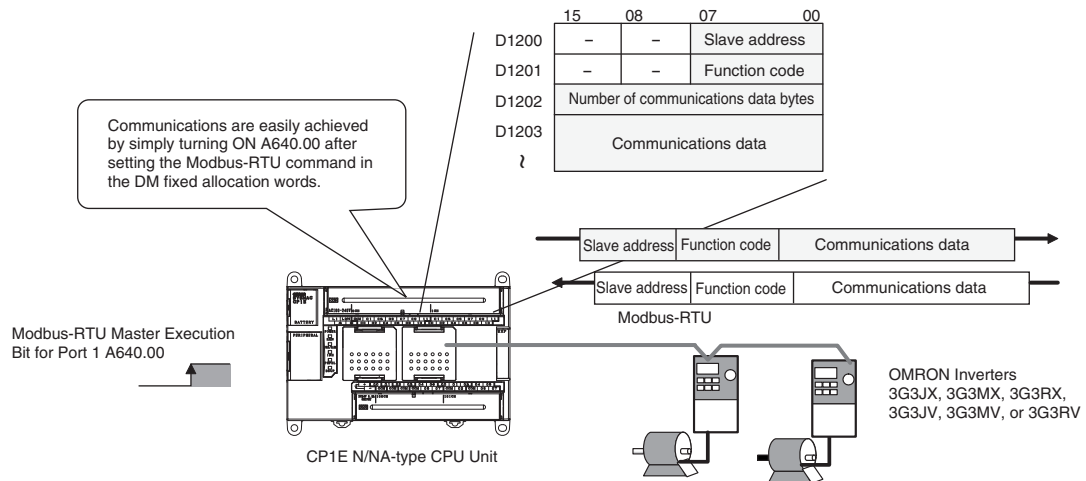

Modbus-RTU commands can be sent simply by turning ON a software switch after setting the Modbus slave address, function, and data in the DM fixed allocation words for the Modbus-RTU Easy Master. The response when received is automatically stored in the DM fixed allocation words for the Modbus-RTU Easy Master.

## 14-4-2 Flow of Operation

- 1

Wiring communications

Connect the CP1E CPU Unit and Modbus-RTU Slave using RS-422A/485 ports.
- ↓
- 2

PLC Setup

Select *Built-in RS232C Port* or *Serial Option Port* in the PLC Setup and transfer the PLC Setup from the CX-Programmer to the CP1E CPU Unit. (Set the serial communications mode to Modbus Easy Master, and set the communications conditions.)
- ↓
- 3

Create ladder Program	Cyclic tasks
	Interrupt tasks

- Set the Modbus-RTU frame in the DM Fixed Allocation Words.
  - Turn ON the Modbus-RTU Master Execution Bit (A640.00 or A641.00).

### 14-4-3 Setting and Word Allocation

DM fixed allocation words and Auxiliary Area words are allocated for the Modbus-RTU Easy Master according to the CPU Unit type and connected port as shown below.

CP1E CPU Unit serial port		DM fixed allocation words	Auxiliary Area bits
CP1E N14/20 or N30/40/60S CPU Unit	Built-in RS-232C port	D1200 to D1299	A640.00 to A640.02
CP1E N30/40/60(S1) or NA20 CPU Unit	Built-in RS-232C port	D1200 to D1299	A640.00 to A640.02
	Serial option port or built-in RS-485 port	D1300 to D1399	A641.00 to A641.02

#### ● DM Fixed Allocation Words

Word		Bits		Contents
Built-in RS-232C port of CP1E N14/20/30/40/60 (S□) or NA20 CPU Unit	Serial option port or built-in RS-485 port of CP1E N30/40/60(S1) or NA20 CPU Unit			
D1200	D1300	00 to 07	Command	Slave address (00 to F7 hex)
		08 to 15		Reserved (Always 00 hex.)
D1201	D1301	00 to 07		Function code
		08 to 15		Reserved (Always 00 hex.)
D1202	D1302	00 to 15		Number of communications data bytes (0000 to 005E hex)
D1203 to D1249	D1303 to D1349	00 to 15		Communications data (94 bytes maximum)
D1250	D1350	00 to 07	Response	Slave address (01 to F7 hex)
		08 to 15		Reserved (Always 00 hex.)
D1251	D1351	00 to 07		Function code
		08 to 15		Reserved
D1252	D1352	00 to 07		Error code (See error codes in the following table. )
		08 to 15		Reserved (Always 00 hex.)
D1253	D1353	00 to 15		Number of response bytes (0000 to 03EA hex)
D1254 to D1299	D1354 to D1399	00 to 15		Response data (92 bytes maximum)

## ● Error Codes

Code	Description	Description
00 hex	Normal end	—
01 hex	Illegal address	The slave address specified in the parameter is illegal (248 or higher).
02 hex	Illegal function code	The function code specified in the parameter is illegal.
03 hex	Data length overflow	There are more than 94 data bytes.
04 hex	Serial communications mode error	The Modbus-RTU Easy Master function was executed when the serial communications mode was not the Modbus-RTU Easy Master Mode or when the option board is not equipped.
80 hex	Response timeout	A response was not received from the slave.
81 hex	Parity error	A parity error occurred.
82 hex	Framing error	A framing error occurred.
83 hex	Overrun error	An overrun error occurred.
84 hex	CRC error	A CRC error occurred.
85 hex	Incorrect confirmation address	The slave address in the response is different from the one in the request.
86 hex	Incorrect confirmation function code	The function code in the response is different from the one in the request.
87 hex	Response size overflow	The response frame is larger than the storage area (92 bytes).
88 hex	Exception response	An exception response was received from the slave.
89 hex	Service being executed	A service is already being executed (reception traffic congestion).
8A hex	Execution canceled	Executing the service has been canceled.
8F hex	Other error	Other FINS response code was received.

## ● Related Auxiliary Area Words and Bits

The Modbus-RTU command set in the DM fixed allocation words for the Modbus-RTU Easy Master is automatically sent when the Modbus-RTU Master Execution Bit is turned ON. The results (normal or error) will be given in corresponding flags.

Word	Bit	Port	Contents
A640	02	Built-in RS-232C port of CP1E N14/20/30/40/60(S□) or NA20 CPU Unit	Modbus-RTU Master Execution Error Flag ON: Execution error. OFF: Execution normal or still in progress.
	01		Modbus-RTU Master Execution Normal Flag ON: Execution normal. OFF: Execution error or still in progress.
	00		Modbus-RTU Master Execution Bit Turned ON: Execution started ON: Execution in progress. OFF: Not executed or execution completed.
A641	02	Serial option port or built-in RS-485 port of CP1E N30/40/60(S1) or NA20 CPU Unit	Modbus-RTU Master Execution Error Flag ON: Execution error. OFF: Execution normal or still in progress
	01		Modbus-RTU Master Execution Normal Flag ON: Execution normal. OFF: Execution error or still in progress.
	00		Modbus-RTU Master Execution Bit Turned ON: Execution started ON: Execution in progress. OFF: Not executed or execution completed.

### 14-4-4 Programming Examples

A bobbin winder on a spinning machine will be used in the following example.

The speed of the bobbin winder must be controlled as the thread is wound because the speed of the thread is constant.

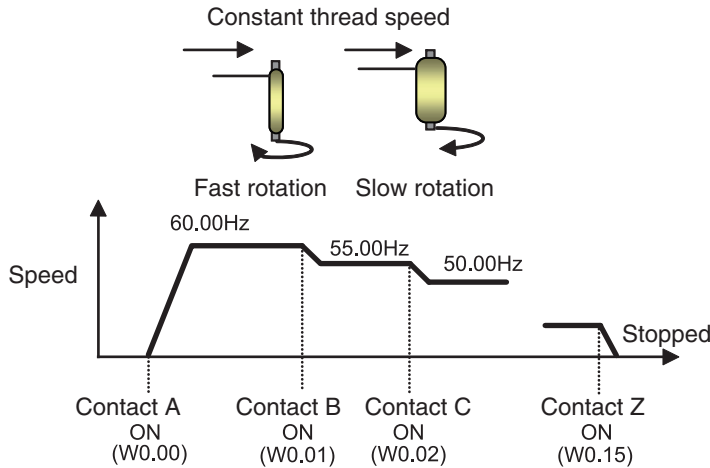

The target speed is changed according to inputs from multiple contacts. Acceleration and deceleration are controlled using the acceleration and deceleration of an inverter.

## Wiring Examples

The CP1E and OMRON 3G3MV Inverter are connected using RS-485 for frequency and start/stop control.

### ● CP1E N□□-type CPU Unit

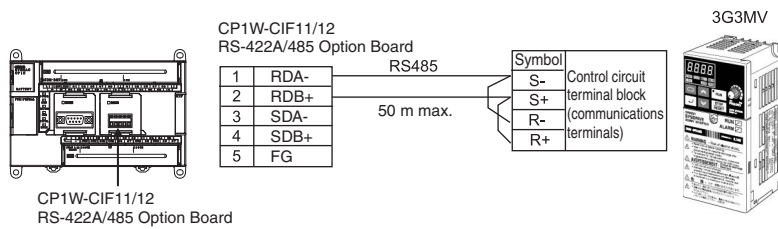

### ● CP1E N□□S1-type CPU Unit

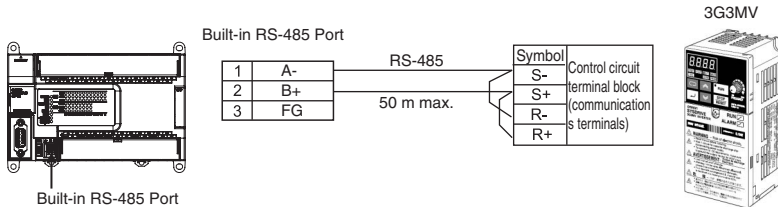

### ● CP1W-CIF11/12 Settings

Set the DIP switch as shown in the following table

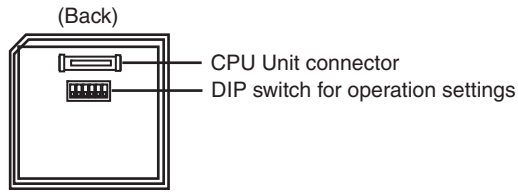

No.	Setting	ON / OFF	Description
1	Terminating resistance selection	ON	Connects terminating resistance
2	2/4-wire selection	ON	2-wire connections
3	2/4-wire selection	ON	2-wire connections
4	–	OFF	Always OFF
5	RS control for RD	ON	Enabled
6	RS control for SD	ON	Enabled

### ● 3G3MV Settings

Set the DIP switch as follows:

- SW2, pin 1 : ON (terminating resistance connected) Terminating resistance for RS422/485 communications
- Set the following parameters.

No.	Name	Setting	Description
n003	RUN command selection	2	RS-422/485 communications is enabled.
n004	Frequency reference selection	6	Frequency reference through RS-422/RS-485
n019	Acceleration time 1	5.0	Acceleration time in seconds
n020	Deceleration time 1	5.0	Deceleration time in seconds
n151	RS-422/485 communications timeover detection selection	1	Detect timeouts, detect fatal errors, and the Inverter decelerates to a stop using deceleration time 1 (default).
n152	RS-422/485 communications frequency reference/display unit selection	1	Select the unit for communications of frequency references and frequency monitoring data. Unit: 0.01Hz (default).
n153	RS-422/485 communications Slave address	1	Slave address (unit number), unit number 1
n154	RS-422/485 communications baud rate selection	2	Communications baud rate: 9,600 bps (default)
n155	RS-422/485 communications parity selection	0	Even parity
n156	RS-422/485 communications send wait time	10	Sets the response wait time for request messages received from the master. 10 ms (default).
n157	RS-422/485 communications RTS control selection	0	RTS control enabled (default)

## ● PLC Setup

Click the **Serial Option Port** Tab in the PLC Settings Dialog Box.

**Note** The built-in RS-485 port of the N□□S1-type CPU Unit should be set in the **Serial Option Port** tab.

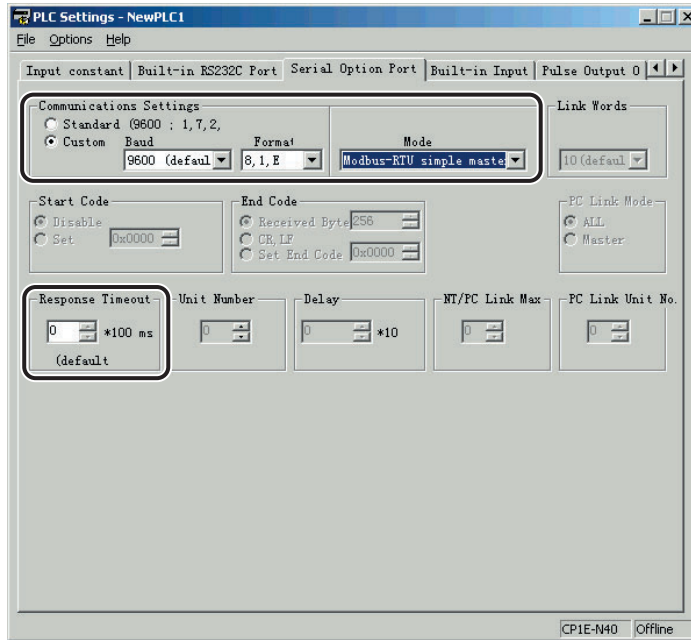

### Serial Option Port Tab Page

Parameter	Settings
Communications Settings	Set the Modbus communications settings to match those of the Inverter. If the Inverter is set to 9,600 bps, one stop bit, and even parity, select the <i>Custom</i> Option and set the baud rate to 9,600. Set the format to <i>8,1,E</i> .
Mode	Select <i>Modbus Easy Master</i> .
Response Timeout	Set the default value of 0×100 ms.



● Programming Example

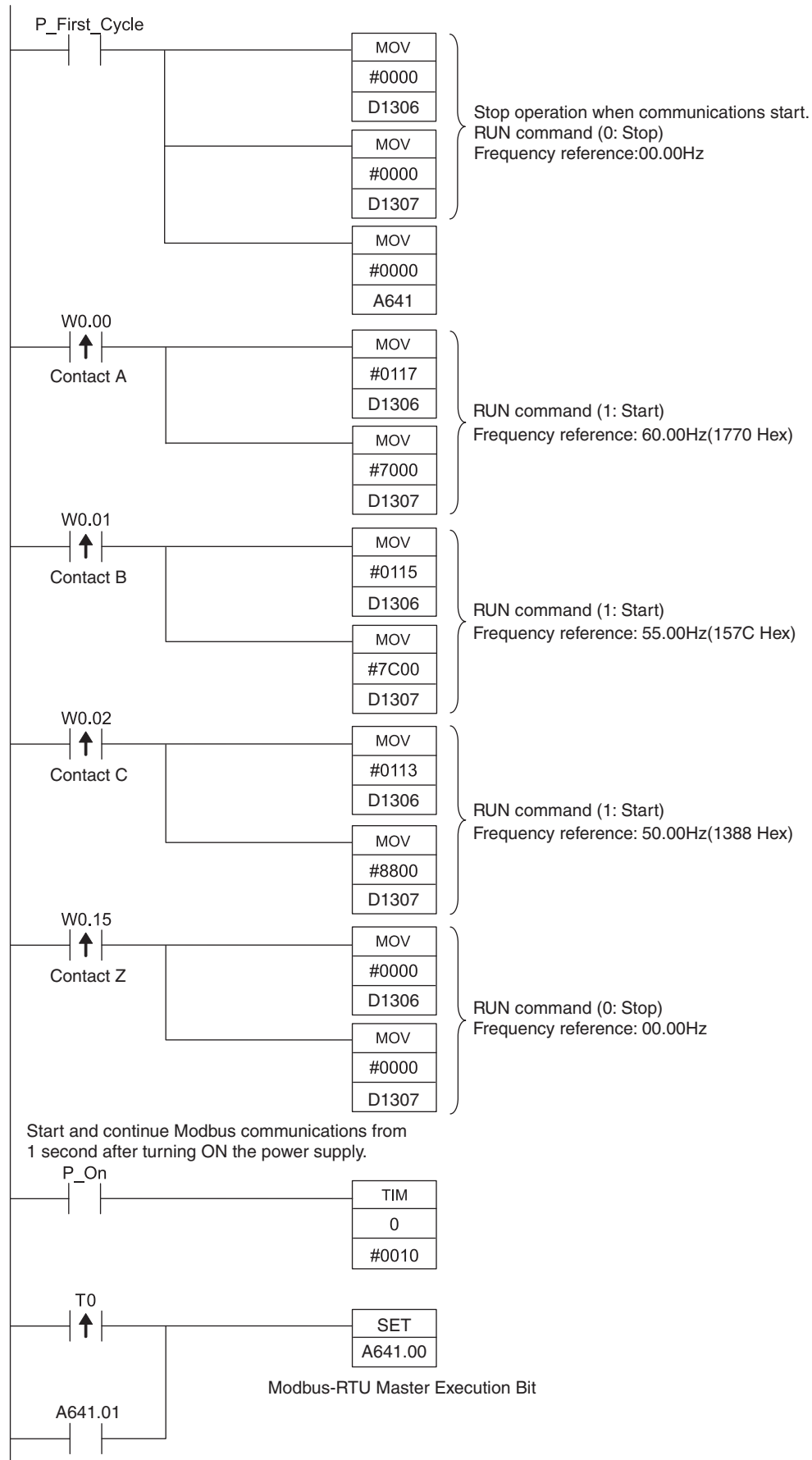

● **Flags for Modbus-RTU Easy Master for Serial Option Port or Built-in RS-485 Port**

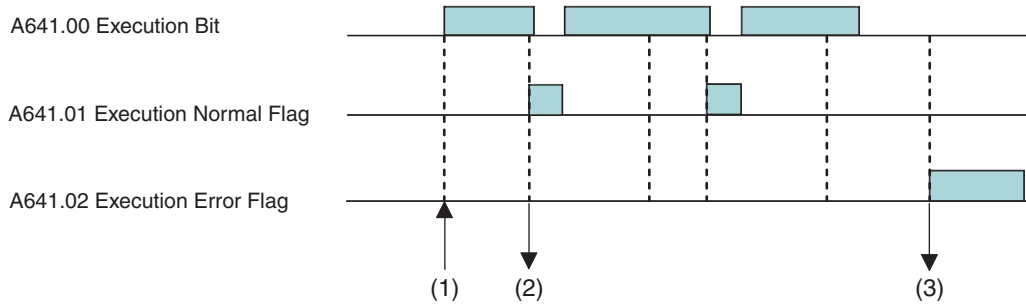

(1) Turn ON A641.00 (Execution Bit) to send command data stored starting at D1300. For details, refer to *DM Area Data* on page 14-19.

Words Serial Option Port	Bits	Setting	
		D1300	00 to 07 08 to 15
		Reserved (Always 00 hex.)	
D1301	00 to 07 08 to 15		Function code
			Reserved (Always 00 hex.)
D1302	00 to 15		Number of communications data bytes (0000 to 005E hex)
D1303 to D1349	00 to 15		Communications data (94 bytes max.)



**Precautions for Correct Use**

The Execution Bit will automatically turn OFF. Do not turn OFF the bit through the ladder.

(2) When a command has been sent successfully, A641.01 (Execution Normal Flag) will turn ON, and the response data will be stored starting from D1350.

Words Serial Option Port	Bits	Setting	
		D1350	00 to 07 08 to 15
		Reserved (Always 00 hex.)	
D1351	00 to 07 08 to 15		Function code
			Reserved
D1352	00 to 07 08 to 15		Error code
			Reserved (Always 00 hex.)
D1353	00 to 15		Number of response bytes (0000 to 03EA hex)
D1354 to D1399	00 to 15		Response data (92 bytes max.)

(3) If a communications error occurs, A641.02 (Execution Error Flag) will turn ON, and the error code will be stored in D1352.

● **DM Area Data**

**DM Fixed Allocation Words for Modbus-RTU Easy Master**

DM Area data in words D1301 to D1305 are set before the execution of the ladder program. D1306 and D1307 do not need to be set. They are modified by MOV instructions, and are used to change, start, and stop frequency references.

Serial Option Port or Built-in RS-485 Port: Command

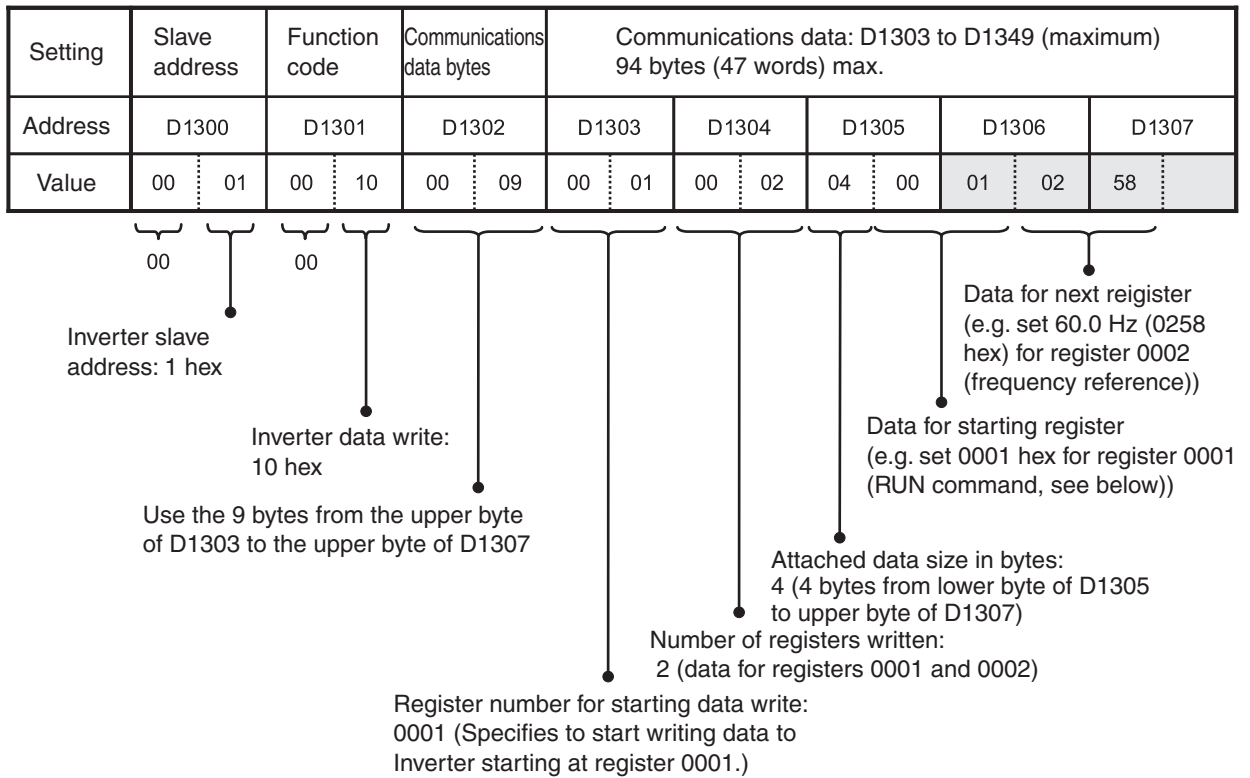

**RUN Command (Register 0001) Allocation and Details for Inverter 3G3MV**

Bit No.	Setting
0	RUN command (1: Start)
1	Normal/reverse rotation (1: Reversed)
2	External error (1: EF0)
3	Error reset (1: Error reset)
4	Multifunction input 1 (1: ON)
5	Multifunction input 2 (1: ON)
6	Multifunction input 3 (1: ON)
7	Multifunction input 4 (1: ON)
8	Multifunction input 5 (1: ON)
9	Multifunction input 6 (1: ON)
10	Multifunction input 7 (1: ON)
11 to 15	(Not used.)

For this example, only the RUN command (bit 00) will be used.

- With the Modbus-RTU Easy Master, a CRC-16 checksum does not need to be set in the DM Area, because it is calculated automatically.

## 14-5 Serial PLC Links

Serial PLC Links can be used only with the CP1E N/NA□□(S)-type CPU Unit.

### 14-5-1 Overview

Serial PLC Links enable exchanging data between CP1E N/NA□□(S)-type CPU Units, CP1L/CP1H CPU Units, or CJ1M CPU Units without using special programming. The serial communications mode is set to Serial PLC Links. Up to 9 PLCs can be linked.

### Configuration

#### ● Connecting CP1E, CP1L, CP1H, or CJ1M CPU Units 1:N (8 Nodes Maximum)

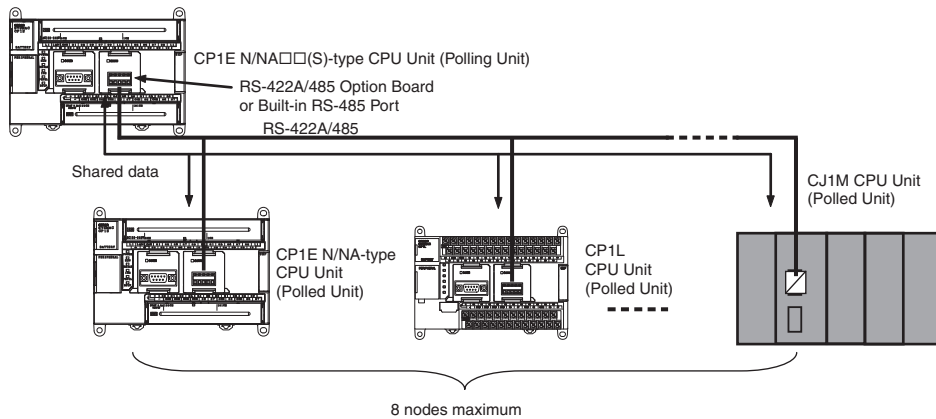

#### ● Connecting CP1E, CP1L, CP1H, or CJ1M CPU Units 1:1

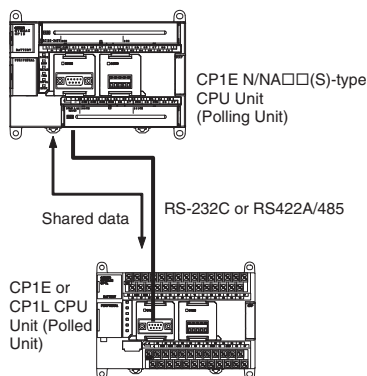

#### Precautions for Correct Use

With the CP1E CPU Units, a Programmable Terminal (PT) cannot be included in a Serial PLC Link.

## 14-5-2 Flow of Operation

- 1 **Wiring communications** Connect the CP1E CPU Unit and the CP1E or other CPU Units using RS-232C or RS-422A/485 ports.
- 2 **PLC Setup** Set *Built-in RS232C Port* or *Serial Option Port* in the PLC Setup and transfer the PLC Setup from the CX-Programmer to the CP1E CPU Unit. (Set the serial communications mode to *Serial PC Link (Master)* or *Serial PC Link (Slave)* and set the communications conditions, link words, and PLC Link method.)
- 3 **Start communications**



### Precautions for Correct Use

Both serial ports cannot be used for PLC Links at the same time.

If both serial ports are set for PLC Links (either as polling or polled nodes), a PLC Setup setting error (nonfatal error) will occur and the PLC Setup Setting Error Flag (A402.10) will turn ON.

## 14-5-3 PLC Setup

### Settings at the Polling Unit

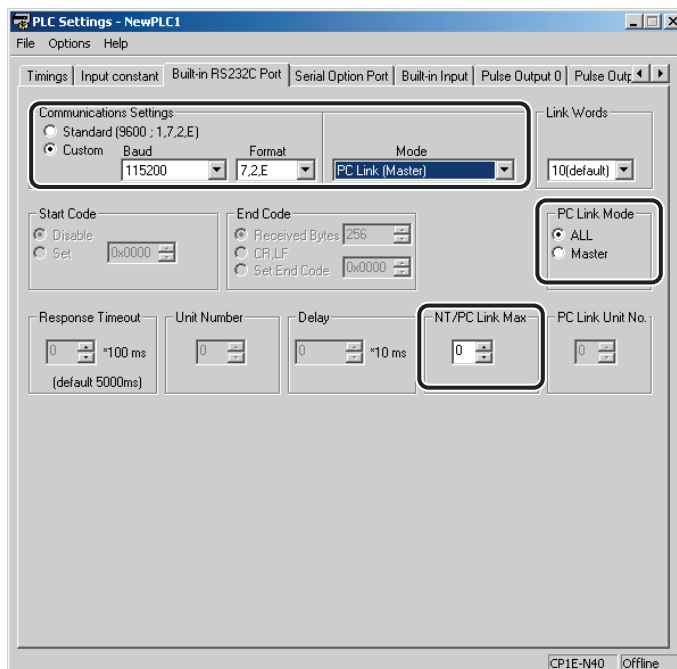

Built-in RS232C Port or Serial Option Port Tab Page

**Note** The built-in RS-485 port of the N□□S1-type CPU Unit should be set in the **Serial Option Port** tab.

Parameter	Setting
Communications Settings	Set the communications settings to the same values as the connected PLCs. If the connected PLCs are set to 115,200 bps, select the <i>Custom</i> Option, set the baud rate to 115200. The format can be set to any value.
Mode	Select <i>PC Link (Master)</i> .
Link Words	Set to 10 (default) for the Master only. 10 words (default)
PC Link Mode	Select <i>All</i> or <i>Master</i> .
NT/PC Link Max.	Set the highest unit number of the connected slaves.

## Settings at the Polled Unit

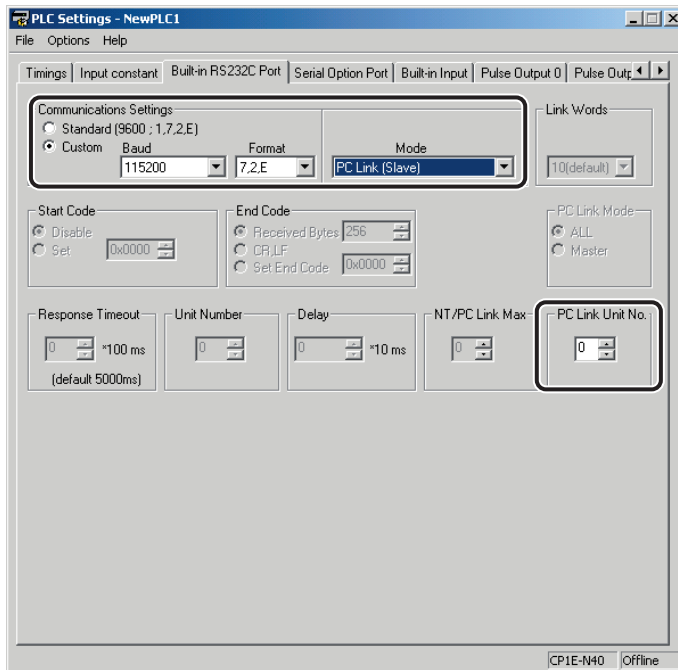

Built-in RS232C Port or Serial Option Port Tab Page

**Note** The built-in RS-485 port of the N□□S1-type CPU Unit should be set in the **Serial Option Port** tab.

Parameter	Setting
Communications Settings	Set the communications settings to the same values as the connected PLCs. If the connected PLCs are set to 115,200 bps, select the <i>Custom</i> Option, set the baud rate to 115200. The format can be set to any value.
Mode	Select <i>PC Link (Slave)</i> .
PC Link Unit No.	Set the unit number (0 to 7).

## 14-5-4 Operating Specifications

Serial PLC Links can be used for built-in RS-232C ports, serial option ports or built-in RS-485 ports for N30/40/60(S□) or NA20 CPU Units. However, two serial ports cannot be used simultaneously for Serial PLC Links.

Item	Specifications
Applicable PLCs	CP1E, CP1H, CP1L, CJ1M
Baud rate	38,400 bps, 115,200 bps
Applicable serial ports	Built-in RS-232C ports, serial option ports or built-in RS-485 ports Both ports cannot be used for Serial PLC Links at the same time. If both ports are set for Serial PLC Links (either as polling node or polled node), a PLC Setup setting error (nonfatal error) will occur and the PLC Setup Setting Error Flag (A402.10) will turn ON.
Connection method	RS-422A/485 or RS-232C connection via RS-422A/485 Option Board, built-in RS-485 port or RS-232C port.
Words allocated in CIO Area	Serial PLC Link Words: CIO 200 to CIO 289 (Up to 10 words can be allocated for each CPU Unit.)
Maximum number of Units	9 Units max., comprising 1 Polling Unit and 8 Polled Units.
Link methods (data refresh methods)	Complete link method or Polling Unit link method

### Data Refresh Methods

The following two methods can be used to refresh data.

- Complete link method
- Polling Unit link method

● Complete Link

The data from all nodes in the Serial PLC Links are reflected in both the Polling Unit and the Polled Units.

The only exceptions are the addresses of Polled Units that are not present in the network. These data areas are undefined in all nodes.

Example: Complete Link Method, Highest Unit Number: 3

In the following diagram, Polled Unit No. 2 is a Unit not present in the network, so the area allocated for Polled Unit No. 2 is undefined in all nodes.

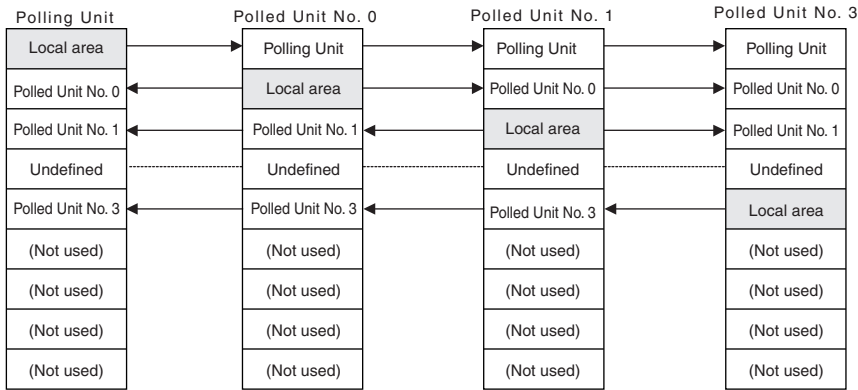

Example for Ten Link Words (Maximum Number of Words)

Each CPU Unit (either CP1E, CP1L, CP1H, or CJ1M) sends data to the same words in all other CPU Units for the Polling Unit and all Polled Units. Data is sent between the words that are allocated to the Polling Unit and Polled Units according to unit numbers.

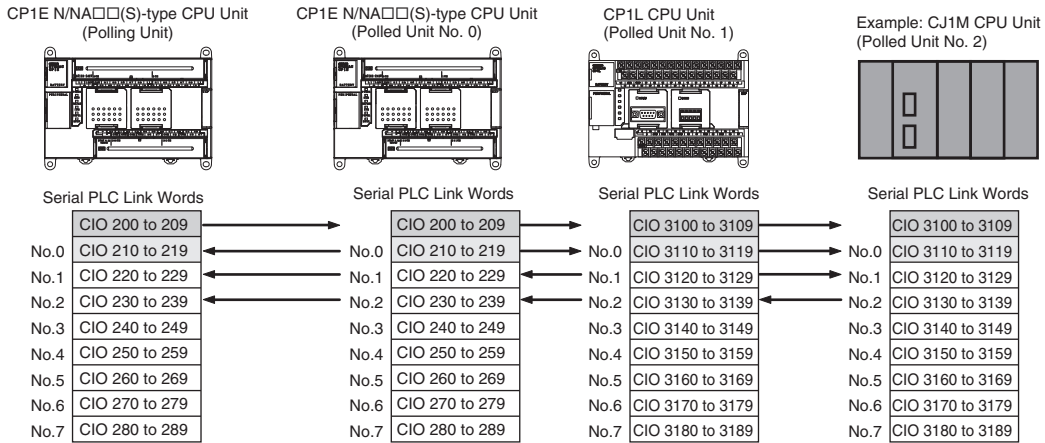



● **Polling Unit Link Method**

The data for all the Polled Units in the Serial PLC Links are reflected in the Polling Unit only, and each Polled Unit reflects the data of the Polling Unit only.

The advantage of the Polling Unit link method is that the addresses allocated for the local Polled Unit data are the same in each Polled Unit, allowing data to be accessed using common ladder programming.

The areas allocated for Polled Units not present in the network are undefined in the Polling Unit only.

Example: Polling Unit Link Method, Highest Unit Number: 3

In the following diagram, Polled Unit No. 2 is a Unit not participating in the network, so the corresponding area in the Polling Unit is undefined.

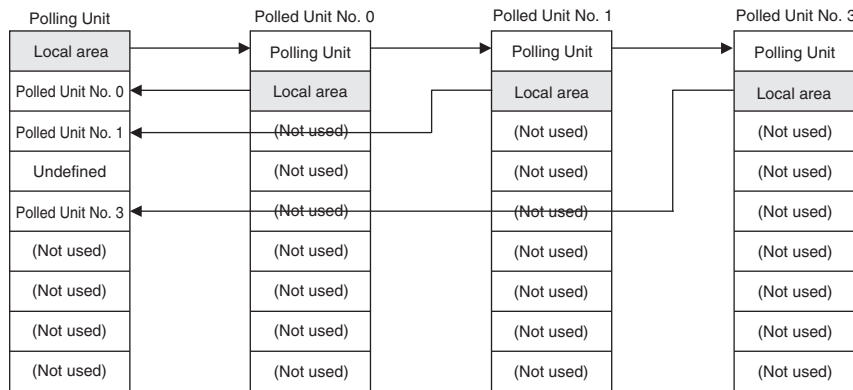

Example for Ten Link Words (Maximum Number of Words)

The CPU Unit that is the Polling Unit (either CP1E, CP1H, CP1L, or CJ1M) sends its data (CIO 200 to CIO 209) to the same words (CIO 200 to CIO 209) in all other CPU Units.

The Polled Units (either CP1E, CP1H, CP1L, or CJ1M) send their data (CIO 210 to CIO 219) to consecutive sets of 10 words (CIO 210 to CIO 289) in the Polling Unit.

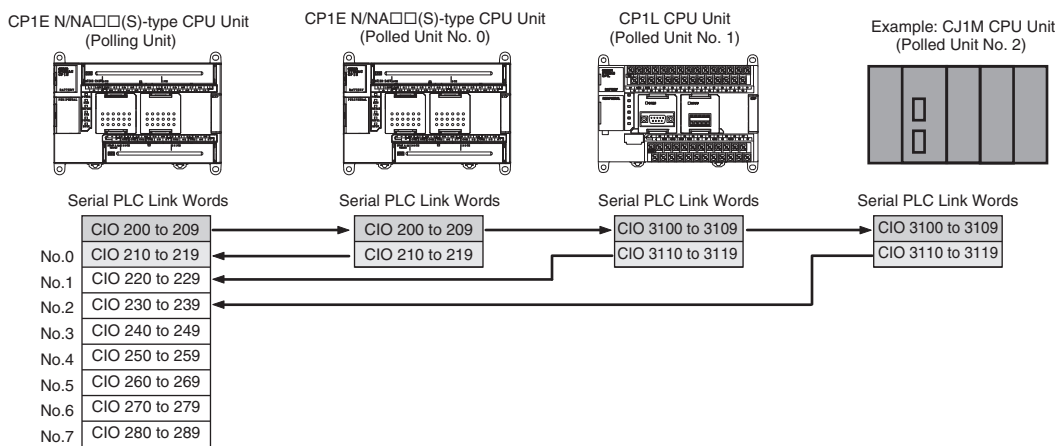

● Allocated Words

**Complete Link Method**

Address		Link words	1 word	2 words	3 words	to	10 words
CIO 200	Serial PLC Link Area	Polling Unit	CIO 200	CIO 200 to 201	CIO 200 to 202		CIO 200 to 209
		Polled Unit No. 0	CIO 201	CIO 202 to 203	CIO 203 to 205		CIO 210 to 219
		Polled Unit No. 1	CIO 202	CIO 204 to 205	CIO 206 to 208		CIO 220 to 229
		Polled Unit No. 2	CIO 203	CIO 206 to 207	CIO 209 to 211		CIO 230 to 239
		Polled Unit No. 3	CIO 204	CIO 208 to 209	CIO 212 to 214		CIO 240 to 249
		Polled Unit No. 4	CIO 205	CIO 210 to 211	CIO 215 to 217		CIO 250 to 259
		Polled Unit No. 5	CIO 206	CIO 212 to 213	CIO 218 to 220		CIO 260 to 269
		Polled Unit No. 6	CIO 207	CIO 214 to 215	CIO 221 to 223		CIO 270 to 279
		Polled Unit No. 7	CIO 208	CIO 216 to 217	CIO 224 to 226		CIO 280 to 289
CIO 289			Not used.	CIO 209 to 289	CIO 218 to 289	CIO 227 to 289	

**Polling Unit Link Method**

Address		Link words	1 word	2 words	3 words	to	10 words
CIO 200	Serial PLC Link Words	Polling Unit	CIO 200	CIO 200 to 201	CIO 200 to 202		CIO 200 to 209
		Polled Unit No. 0	CIO 201	CIO 202 to 203	CIO 203 to 205		CIO 210 to 219
		Polled Unit No. 1	CIO 201	CIO 202 to 203	CIO 203 to 205		CIO 210 to 219
		Polled Unit No. 2	CIO 201	CIO 202 to 203	CIO 203 to 205		CIO 210 to 219
		Polled Unit No. 3	CIO 201	CIO 202 to 203	CIO 203 to 205		CIO 210 to 219
		Polled Unit No. 4	CIO 201	CIO 202 to 203	CIO 203 to 205		CIO 210 to 219
		Polled Unit No. 5	CIO 201	CIO 202 to 203	CIO 203 to 205		CIO 210 to 219
		Polled Unit No. 6	CIO 201	CIO 202 to 203	CIO 203 to 205		CIO 210 to 219
		Polled Unit No. 7	CIO 201	CIO 202 to 203	CIO 203 to 205		CIO 210 to 219
CIO 289			Not used.	CIO 202 to 289	CIO 204 to 289	CIO 206 to 289	

## ● Related Auxiliary Area Bits and Words

### Built-in RS-232C Port

Name	Address	Details	Read/write	Refresh timing
Built-in RS-232C Port Communicating with Polled Unit Flags*	A393.00 to A393.07	When built-in RS-232C port is being used in NT link mode, the bit corresponding to the Unit performing communications will be ON. Bits 00 to 07 correspond to unit numbers 0 to 7, respectively. ON: Communicating OFF: Not communicating	Read	<ul style="list-style-type: none"> <li>Cleared when power is turned ON.</li> <li>Turns ON the bit corresponding to the unit number of the Polled Unit that is communicating via built-in RS-232C port in NT link mode or Serial PLC Link mode.</li> <li>Bits 00 to 07 correspond to unit numbers 0 to 7, respectively.</li> </ul>
Built-in RS-232C Port Restart Bit	A526.00	Turn ON this bit to restart built-in RS-232C port.	Read/write	<ul style="list-style-type: none"> <li>Cleared when power is turned ON.</li> <li>Turn ON to restart built-in RS-232C port.</li> </ul> <p><b>Note</b> The bit is automatically turned OFF by the system when restart processing has been completed.</p>
Built-in RS-232C Port Error Flags	A528.00 to A528.07	When an error occurs at built-in RS-232C port, the corresponding error bit is turned ON. Bit 0: Not used. Bit 1: Not used. Bit 2: Parity error Bit 3: Framing error Bit 4: Overrun error Bit 5: Timeout error Bit 6: Not used. Bit 7: Not used.	Read/write	<ul style="list-style-type: none"> <li>Cleared when power is turned ON.</li> <li>When an error occurs at built-in RS-232C port, the corresponding error bit is turned ON.</li> <li>The flag is automatically turned OFF by the system when built-in RS-232C port is restarted.</li> <li>In NT link mode, only bit 05 (timeout error) is enabled.</li> <li>In Serial PLC Link mode, only the following bits are enabled. Errors at the Polling Unit: Bit 05: Timeout error Errors at Polled Units: Bit 05: Timeout error Bit 04: Overrun error Bit 03: Framing error</li> </ul> <p><b>Note</b> If the error occurred in Serial PLC link mode, the console will retry before communication establish. Rehabilitation of the communications is no need for port restart. If user eliminates error, the communication will automatically establish between console and servo. However, error flag will be saved as the record. If you want to clear the error flag, please restart port.</p>

### Serial Option Port/Built-in RS-485 Port

Name	Address	Details	Read/write	Refresh timing
Serial Option Port/ Built-in RS-485 Port Communicating with Polled Unit Flags*	A394.00 to A394.07	When serial option port or built-in RS-485 port is being used in NT link mode, the bit corresponding to the Unit performing communications will be ON. Bits 00 to 07 correspond to unit numbers 0 to 7, respectively. ON: Communicating OFF: Not communicating	Read	<ul style="list-style-type: none"> <li>• Cleared when power is turned ON.</li> <li>• Turns ON the bit corresponding to the unit number of the Polled Unit that is communicating via serial option port or built-in RS-485 port in NT link mode or Serial PLC Link mode.</li> <li>• Bits 00 to 07 correspond to unit numbers 0 to 7, respectively.</li> </ul>
Serial Option Port/ Built-in RS-485 Port Restart Flags	A526.01	Turn ON this bit to restart serial option port or built-in RS-485 port.	Read/write	<ul style="list-style-type: none"> <li>• Cleared when power is turned ON.</li> <li>• Turn ON to restart serial option port or built-in RS-485 port.</li> </ul> <p><b>Note</b> The bit is automatically turned OFF by the system when restart processing has been completed.</p>
Serial Option Port/ Built-in RS-485 Port Error Flags	A528.08 to A528.15	When an error occurs at serial option port or built-in RS-485 port, the corresponding error bit is turned ON. Bit 8: Not used. Bit 9: Not used. Bit 10: Parity error Bit 11: Framing error Bit 12: Overrun error Bit 13: Timeout error Bit 14: Not used. Bit 15: Not used.	Read/Write	<ul style="list-style-type: none"> <li>• Cleared when power is turned ON.</li> <li>• When an error occurs at serial option port or built-in RS-485 port, the corresponding error bit is turned ON.</li> <li>• The flag is automatically turned OFF by the system when serial option port or built-in RS-485 port is restarted.</li> <li>• In NT link mode, only bit 13 (timeout error) is enabled.</li> <li>• In Serial PLC Link mode, only the following bits are enabled. Errors at the Polling Unit: Bit 13: Timeout error Errors at Polled Units: Bit 13: Timeout error Bit 12: Overrun error Bit 11: Framing error</li> </ul> <p><b>Note</b> If the error occurred in Serial PLC link mode, the console will retry before communication establish. Rehabilitation of the communications is no need for port restart. If user eliminates error, the communication will automatically establish between console and servo. However, error flag will be saved as the record. If you want to clear the error flag, please restart port.</p>

\* In the same way as for the existing 1:N NT Link, the status (communicating/not communicating) of the Polled Unit in Serial PLC Links can be checked from the Polling Unit (CPU Unit) by reading the Built-in RS-232C Port Communicating with Polled Unit Flag (A393.00 to A393.07 for unit numbers 0 to 7) or the Serial Option Port/Built-in RS-485 Port Communicating with Polled Unit Flag (A394.00 to A394.07 for unit numbers 0 to 7).  
When errors occur in the Serial PLC Links communication, PC Link Master station would retry before the communication reestablished. So it is not necessary for users to restart the port for restoring the communication. If the errors have been removed, the communication between PC Link (Master) and PC Link (Slave) will be reestablished automatically. But the error flags remained. Please restart the port if you want to clear the error flags.

## 14-5-5 Example Application

### Operation

The present temperature information is exchanged between the boilers. This information is used to adjust the temperature control of one boiler depending on the status of the other boilers and for monitoring individual boilers.

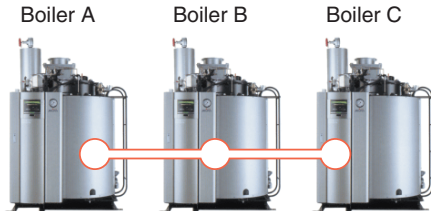

### ● Wiring Example

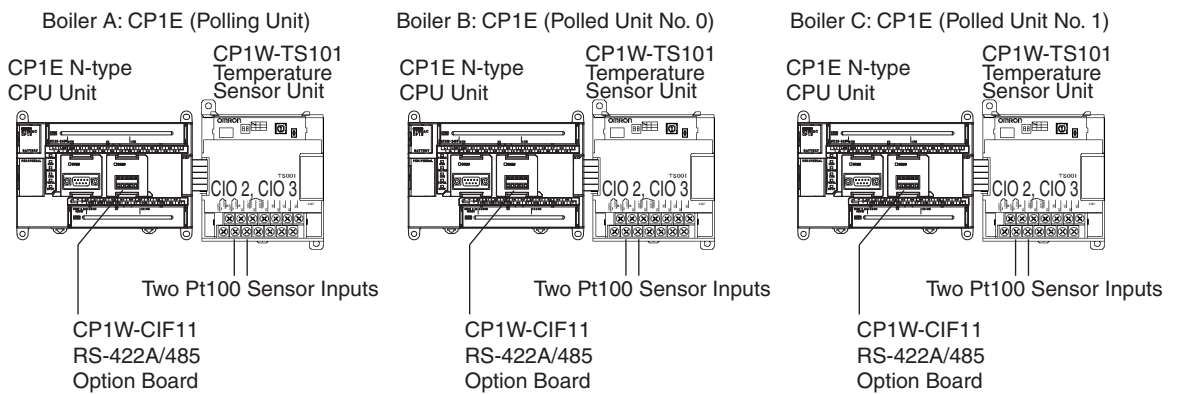

#### CP1E N□□-type

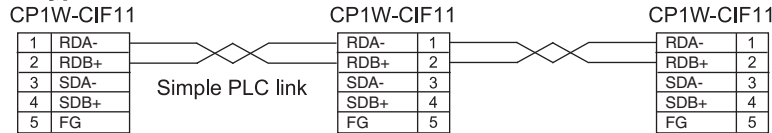

#### CP1E N□□S1-type

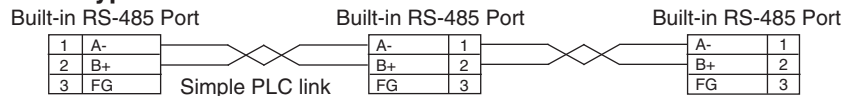

### ● CP1W-CIF11 RS422/485 Option Board DIP Switch Settings

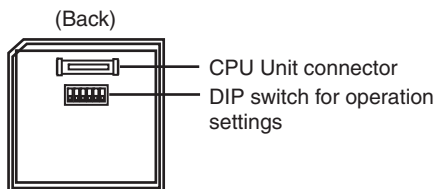

No.	Settings	Polling Unit	Polled Unit No. 0	Polled Unit No. 1	Description
1	Terminating resistance selection	ON	OFF	ON	PLCs at both ends must have terminating resistance connected.
2	2-wire or 4-wire selection	ON	ON	ON	2-wire
3	2-wire or 4-wire selection	ON	ON	ON	2-wire
4	—	OFF	OFF	OFF	Always OFF
5	RS control selection for RD	OFF	OFF	OFF	Control disabled
6	RS control selection for SD	ON	ON	ON	Control enabled

● PLC Setup

Item	Boiler A (Polling Unit)	Boiler B (Polled Unit No. 0)	Boiler C (Polled Unit No. 1)
Communications Settings	Custom		
Baud Rate	115200bps		
Parameters	7.2.E (default)		
Mode	PC Link (Master)	PC link (Slave)	
Link words	10 (default)	–	–
PC Link Mode	ALL	–	–
NT/PC Link Max.	1	–	–
PC Link Unit No.	–	0	1

● Programming Example

Data in the Serial PLC Link Areas are transferred using data links by the Serial PLC Link and without using any special programming. The ladder program is used to transfer the data that needs to be linked to the data link area.

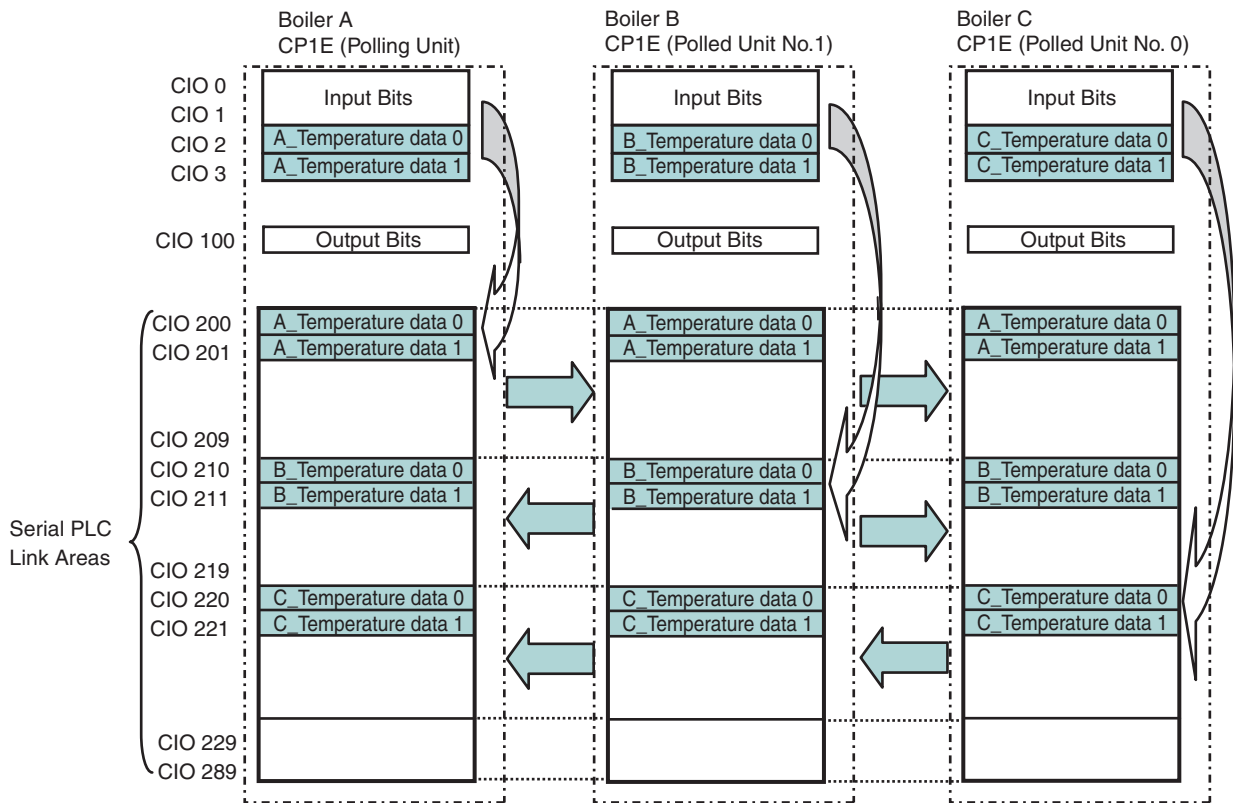

● Ladder Diagram

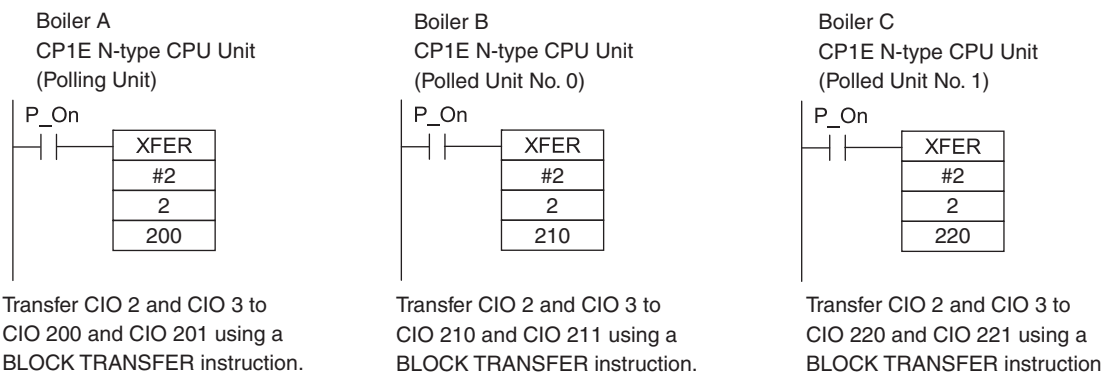



# 14-6 Connecting the Host Computer

Host computers can be connected using this method only with the CP1E N/NA□□(S)-type CPU Unit.

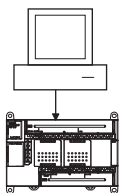

## 14-6-1 Overview

Commands are sent from a host computer to the CP1E CPU Unit to read and write data. The serial communications mode is set to Host Link.

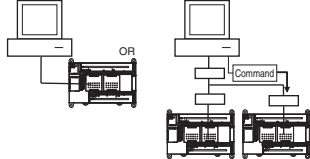
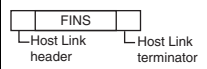
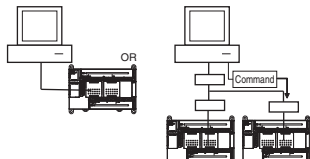
**Note** Because the built-in RS-485 port of the N□□S1-type CPU Unit uses 2-wire connections, so it can only communicate in half duplex. Communications are not possible in full duplex.

Command flow	Command type	Communications method	Configuration	Application	Remarks
Host computer → PLC 	Host link command (C Mode) 	Create frame in the host computer and send the command to the PLC. Receive the response.	Directly connect the host computer in a 1:1 or 1:N system. 	Use this method when communicating primarily from the host computer to the PLC.	-
	FINS command (with Host Link header and terminator) sent. 		Directly connect the host computer in a 1:1 system or 1:N system. 		

## 14-6-2 Flow of Operation

- 1** Communications wiring Connect the computer and CP1E CPU Unit using RS-232C ports.
- 
- 2** PLC Setup Set the PLC Setup (select Host Link for the serial communications mode and set the communications conditions) and transfer the PLC Setup from the CX-Programmer to the CP1E CPU Unit.
- 
- 3** Program from host Send the following commands from the host computer.
  - C-mode commands
  - FINS commands

### 14-6-3 Command/response Format and List of Commands

The outline of command/response format and each command are listed below.

For the details of the host link commands and FINS commands, refer to *Communication Instructions Reference Manual* (Cat.No.W342).

#### ● List of C Mode Commands

C mode commands (host link commands) are shown below.

Type	Header code	Name	Function
I/O memory read	RR	CIO area read	Read the specified words from the specified words of CIO area
	RH	Holding area read	Read the specified words from the specified words of Holding area (H)
	RC	Timer and Counter PV area read	Read the specified present values of timer and counter from the specified words
	RG	Timer and Counter Completion Flag read	Read the specified Completion Flag of timer and counter from the specified words
	RD	DM area read	Read the specified words from the specified words of DM area (D)
	RJ	Auxiliary area read	Read the specified words from the specified words of Auxiliary area (A)
I/O memory write	WR	CIO area write	Write the specified source words from the specified words of CIO area in the unit of word
	WH	Holding area write	Write the specified source words from the specified words of Holding area (H) in the unit of word
I/O memory write	WC	Timer and Counter PV area write	Write the specified source words from the specified words of Timer and Counter present value area in the unit of word
	WD	DM area write	Write the specified source words from the specified words of DM area (D) in the unit of word
	WJ	Auxiliary area write	Write the specified source words from the specified words of Auxiliary area (A) in the unit of word
CPU Unit status related	MS	CPU Unit status read	Read the CPU Unit operating conditions (operating mode, forced set/reset, fatal error)
	SC	Status change	Change the operating mode of CPU Unit
	MF	Error information read	Read the occurring error information of CPU Unit (fatal error, non-fatal error)
Test	TS	Test	Directly return 1 block sent from the host computer
I/O memory area mixed read	QQMR	I/O memory area mixed read registration	Register the I/O memory words or bits that need to read into the table
	QQIR	I/O memory area mixed registration	Read all of the I/O memory area words and bits that were registered
Host link communication processing	XZ	Abort (command only)	Interrupt the operation that being processed using the host link command, and return to the initial status after abortion
	**	Initial (command only)	Initialize the transmission control sequence for all the host link unit numbers
	IC	Command undefined error (response only)	Response when the command's header code cannot be broken



### ● List of FINS commands

FINS commands are shown below.

Type	Command code		Name	Function
I/O memory area access	01	01	I/O memory area read	Read the contents of continuous I/O memory area
	01	02	I/O memory area write	Write the contents of continuous I/O memory area
	01	03	I/O memory area write all at once	Replenish the specified ranges of I/O memory area with the same data
	01	04	I/O memory area mixed read	Read the contents of discontinuous I/O memory area
Parameter area access	02	01	Parameter area read	Read the contents of continuous parameter area
	02	02	Parameter area write	Write the contents of continuous parameter area (unable to execute in MONITOR or RUN mode)
	02	03	Parameter area write (clear) all at once	Replenish the specified ranges of parameter area with the same data
Operating mode change	04	01	Operating mode change (Operation start)	Change the operating mode of CPU Unit to RUN or MONITOR mode
	04	02	Operating mode change (Operation stop)	Change the operating mode of CPU Unit to PROGRAM mode
System configuration read	05	01	CPU Unit information read	Read CPU Unit information
Status read	06	01	CPU Unit status read	Read the status information of CPU Unit
	06	20	Cycle time read	Read cycle time (MAX, MIN, AVERAGE)
Time information access	07	01	Time information read	Read present year, month, day of the month, hour, minute, second, day of the week
	07	02	Time information write	Change present year, month, day of the month, hour, minute, second, day of the week
Message display related	09	20	Message read/cancel	Read FAL and FALS
Debugging related	21	03	Error log pointer clearance	Clear all the pointer of error log to zero
	23	01	Force-set/reset	Force-set, force-reset and release (unable to specify multi-bit)
	23	02	All bits release	Release the forced status of all bits

## 14-7 Precautions on the usage of RS-485

When using the built-in RS-485 of the N□□S1-type CPU Unit, or the RS-485 (2-wire) of the Option Board CP1W-CIF11/CIF12 mounting on the N□□-type CPU Unit, pay attention to the following precautions and construct application.

When using the RS-485 (2-wire), it can only communicate in half duplex. Please secure the waiting time shown below till the next data transmission after the remote device receives data from CP1E. If the receive data are transmitted from the remote device within the waiting time shown below after CP1E data transmission, the data may not be received by CP1E.

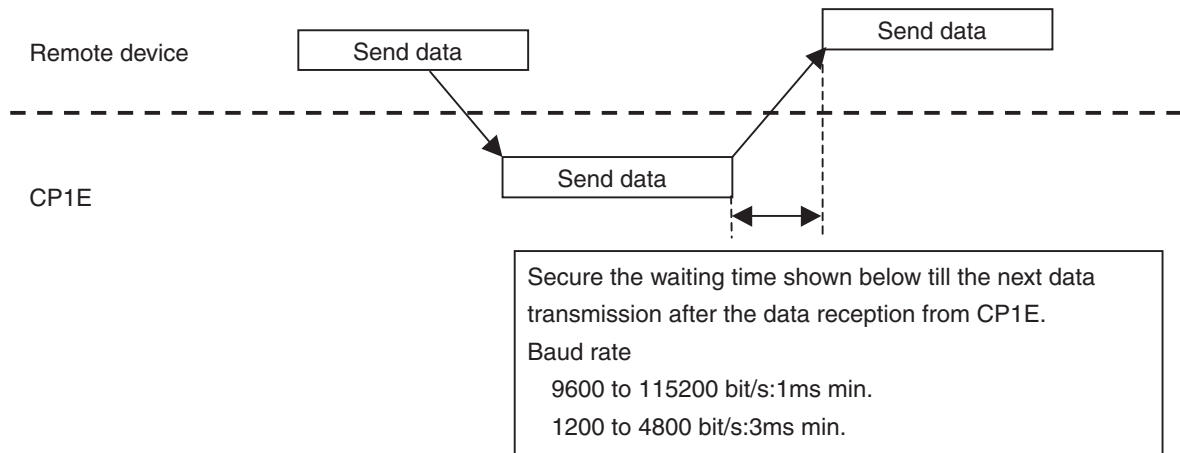

# 15

## Analog I/O Function

This section describes the built-in analog function for NA-type CPU Units.

---

<b>15-1 Overview</b> .....	<b>15-2</b>
15-1-1 Flow of Operation .....	15-2
15-1-2 Analog I/O Specifications .....	15-6
<b>15-2 Analog Input and Output Signal Ranges</b> .....	<b>15-7</b>
15-2-1 Analog Input Signal Ranges .....	15-7
15-2-2 Analog Output Signal Ranges .....	15-9
15-2-3 Special functions .....	15-11
<b>15-3 I/O Allocation and Related Auxiliary Area Flags</b> .....	<b>15-12</b>
15-3-1 I/O Allocation .....	15-12
15-3-2 Related Auxiliary Area Flags .....	15-12

# 15-1 Overview

## 15-1-1 Flow of Operation

- 1** PLC Setup

  - Set whether each input or output will be used. (Each I/O point is set independently.)
  - Set the I/O resolution. (The same setting is used for all I/O points.)
  - Set the analog input range: 0 to 5 V, 1 to 5 V, 0 to 10 V, -10 to 10 V, 0 to 20mA or 4 to 20mA (Each input is set independently.)
  - Set the analog output range: 0 to 5 V, 1 to 5 V, 0 to 10 V, -10 to 10 V, 0 to 20mA or 4 to 20mA (Each output is set independently.)
- 2** Wiring analog I/O

  - Wire the I/O devices. Select correct wire method according to the voltage or current input.
- 3** Write the ladder program

  - Analog inputs: Read the conversion value.
  - Analog outputs: Write the conversion value.

## PLC Setup

Use the CX-Programmer to set the various PLC Setup including whether the I/O point is being used, the input range, output range and averaging function usage. The I/O point usage, input range, output range, and averaging function usage can be set independently for each I/O point.

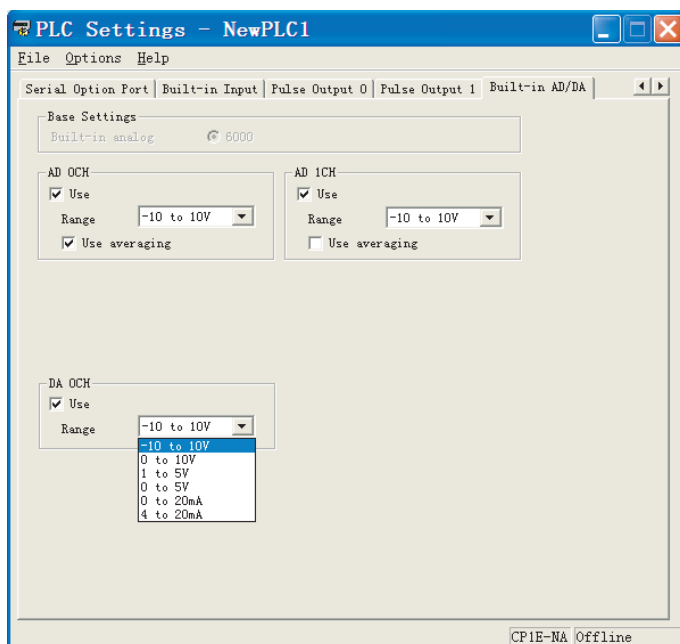

- The input range can be set to -10 to 10 V, 0 to 10 V, 1 to 5 V, 0 to 5 V, 0 to 20 mA or 4 to 20 mA.
- The output range can be set to -10 to 10 V, 0 to 10 V, 1 to 5 V, 0 to 5 V, 0 to 20 mA or 4 to 20 mA.
- Once the range has been set, it cannot be changed as long as the CP1E CPU Unit's power is ON. To change the input range or output range, change the setting in the PLC Setup, turn the CPU Unit OFF, and then turn the CPU Unit ON again.

## Wiring Analog I/O

### ● Wiring Analog Inputs

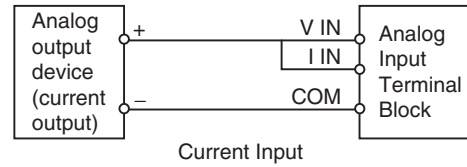
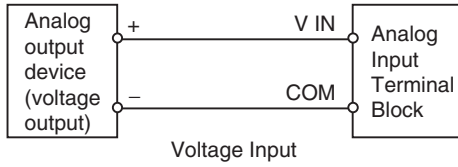

CP1E-NA20DR-A

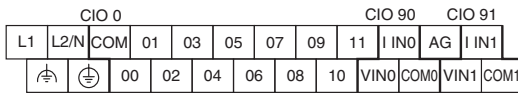

CP1E-NA20D□-D

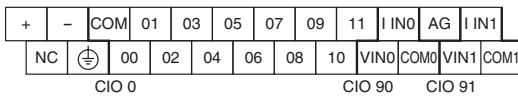

VIN0	Analog input 0 voltage input
IIN0	Analog input 0 current input
COM0	Analog input 0 common
AG	Analog 0V
VIN1	Analog input 1 voltage input
IIN1	Analog input 1 current input
COM1	Analog input 1 common

### ● Wiring Analog Outputs

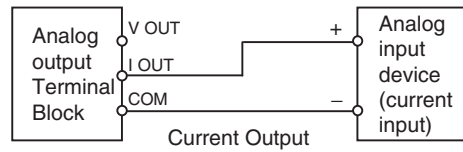
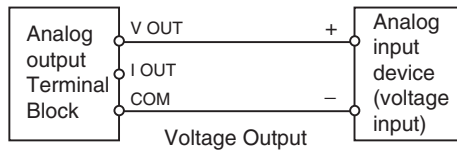

CP1E-NA20DR-A

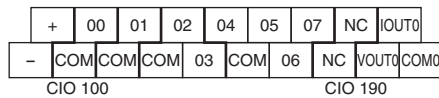

CP1E-NA20D□-D

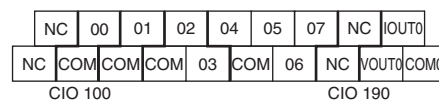

VOUT0	Analog output 0 voltage output
IOUT0	Analog output 0 current output
COM0	Analog output 0 common

- Note 1** Use 2-conductor shielded twisted-pair cable for the I/O wiring, and do not connect the shield AG terminal.
- If an input is not being used, connect (short) the input's VIN, I IN and COM terminals.
  - Wire I/O lines apart from power lines (AC power supply lines, three-phase power lines, etc.).
  - If noise is received from power supply lines, insert a noise filter in the power supply input section.

5 Refer to the following diagram regarding wiring disconnections when voltage input is being used.

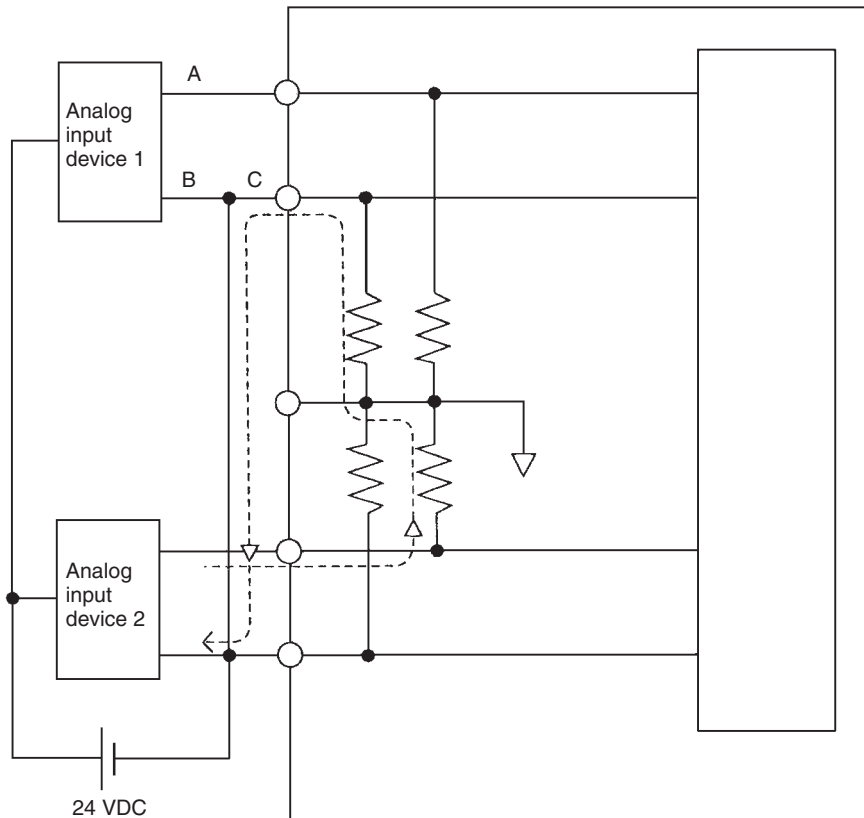

Example: If analog input device 2 is outputting 5 V and the same power supply is being used for both devices as shown above, approximately 1/3, or 1.6 V, will be applied to the input for input device 1.

If a wiring disconnection occurs when voltage input is being used, the situation described below will result. Either separate the power supplies for the connected devices, or use an isolator for each input. If the same power supply is being used by the connected devices and a disconnection occurs at points A or B in the above diagram, an unwanted circuit path will occur as shown along the dotted line in the diagram. If that occurs, a voltage of approximately 1/3 to 1/2 of the output voltage of the other connected device will be generated. If that voltage is generated while the setting is for 1 to 5 V, open-circuit detection may not be possible. Also, if a disconnection occurs at point C in the diagram, the negative (-) side will be used in for both devices and open-circuit detection will not be possible. This problem will not occur for current inputs even if the same power supply is used.

**Note** When external power is supplied (when setting the range code), or when there is a power interruption, pulse-form analog output may be generated. If this causes problems with operation, take countermeasures such as those suggested below.

(1) Countermeasure 1

- Turn ON the power supply for the CP1E CPU Unit first, and then turn ON the power supply for the load after confirming correct operation.
- Turn OFF the power supply for the load before turning OFF the power supply for the CP1E CPU Unit.

(2) Countermeasure 2

- Control the machine not only by analog output but also by other signals (additional start/stop control signal for machine).

## Writing the Ladder Program

### ● Reading A/D Conversion Values

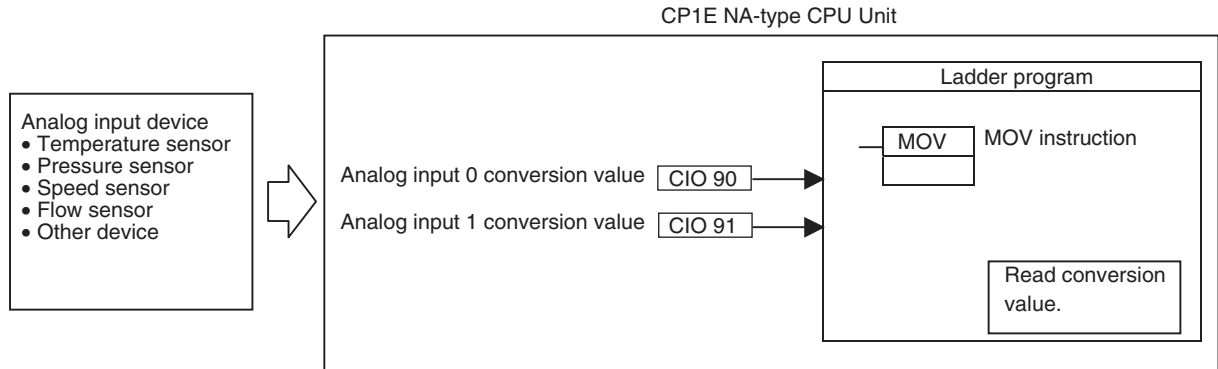

### ● Writing D/A Conversion Values

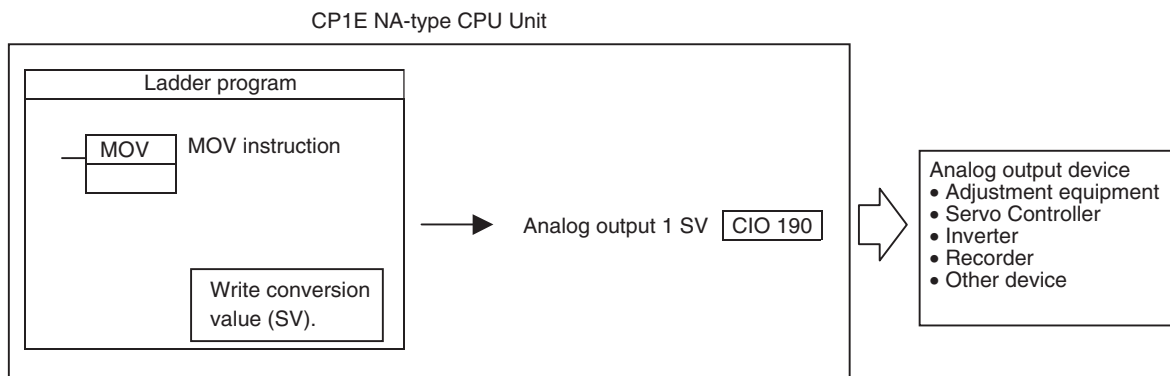

### ● Handling Unit Errors

When an error occurs in the built-in analog I/O system, analog input data will be set to 0000 and the analog output will be set to 0 V or 0 mA.

If a CPU error occurs, the analog output will be set to is set to 0 V or 0 mA even if the output range is 1 to 5 V or 4 to 20 mA. For any other fatal errors in the CPU Unit, 1 V or 4 mA will be output if the output range is 1 to 5 V or 4 to 20 mA.

## 15-1-2 Analog I/O Specifications

The NA-type CPU Units of the CP1E CPU Units are equipped with 2 built-in analog inputs and 1 built-in analog output.

### Analog Input Specifications

Item		Voltage input	Current input
Number of inputs		2 inputs (Allocated 2 words: CIO 90 to CIO 91.)	
Input signal range		0 to 5 V, 1 to 5 V, 0 to 10 V, or -10 to 10 V	0 to 20 mA or 4 to 20 mA
Max. rated input		±15 V	±30 mA
External input impedance		1 MΩ min.	Approx. 250Ω
Resolution		1/6000	
Overall accuracy	At 25°C	±0.3% full scale	±0.4% full scale
	0 to 55°C	±0.6% full scale	±0.8% full scale
A/D conversion data	-10 to 10 V	F448 to 0BB8 hex FS	
	Other ranges	0000 to 1770 hex FS	
Averaging function		Supported (Set for individual inputs in the PLC Setup.)	
Open-circuit detection function		Supported (Value when disconnected: 8000 hex)	

### Analog Output Specifications

Item		Voltage output	Current output
Number of outputs		1 output (Allocated 1 word: CIO 190.)	
Output signal range		0 to 5 V, 1 to 5 V, 0 to 10 V, or -10 to 10 V	0 to 20 mA* or 4 to 20 mA
Allowable external output load resistance		1 kΩ min.	600Ω max.
External input impedance		0.5Ωmax.	---
Resolution		1/6000	
Overall accuracy	At 25°C	±0.4% full scale	
	0 to 55°C	±0.8% full scale	
D/A conversion data	-10 to 10 V	F448 to 0BB8 hex FS	
	Other ranges	0000 to 1770 hex FS	

\* When the analog current output is 0 to 20 mA, the accuracy cannot be ensured at 0.2 mA or less.

### Shared I/O Specifications

Item	Specification
Conversion time	2 ms/point (6 ms total for 2 analog inputs and 1 analog output.)
Isolation method	Photocoupler isolation between analog I/O terminals and internal circuits. No isolation between analog I/O signals.



## 15-2 Analog Input and Output Signal Ranges

Analog I/O data is digitally converted according to the analog I/O signal range as shown below.

**Note** When the input exceeds the specified range, the AD converted data will be fixed at either the lower limit or upper limit.

### 15-2-1 Analog Input Signal Ranges

#### ● -10 to 10 V Input

When the resolution is set to 1/6,000, the -10 to 10-V range corresponds to hexadecimal values F448 to 0BB8 (-3,000 to 3,000). The entire data range is F31C to 0CE4 (-3,300 to 3,300).

A negative voltage is expressed as a two's complement.

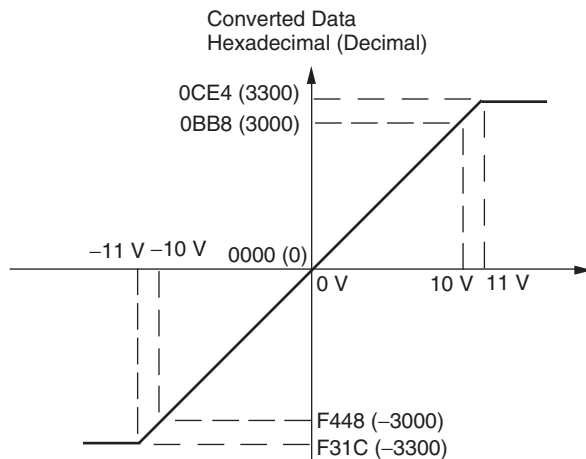

#### ● 0 to 10 V Input

When the resolution is set to 1/6,000, the 0 to 10-V range corresponds to hexadecimal values 0000 to 1770 (0 to 6,000). The entire data range is FED4 to 189C (-300 to 6,300).

A negative voltage is expressed as a two's complement.

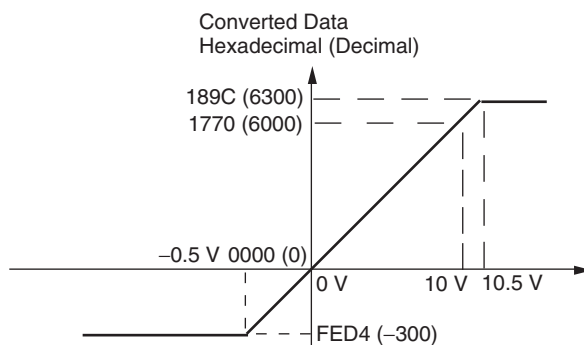

### ● 0 to 5 V Input

When the resolution is set to 1/6,000, the 0 to 5-V range corresponds to hexadecimal values 0000 to 1770 (0 to 6,000). The entire data range is FED4 to 189C (-300 to 6,300).

A negative voltage is expressed as a two's complement.

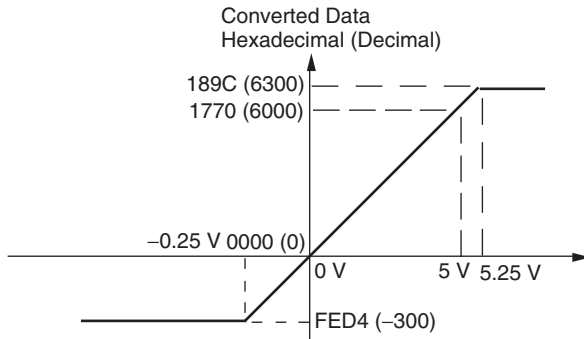

### ● 1 to 5 V Input

When the resolution is set to 1/6,000, the 1 to 5-V range corresponds to hexadecimal values 0000 to 1770 (0 to 6,000). The entire data range is FED4 to 189C (-300 to 6,300).

Inputs between 0.8 and 1 V are expressed as two's complements. If the input falls below 0.8 V, open-circuit detection will activate and converted data will be 8000.

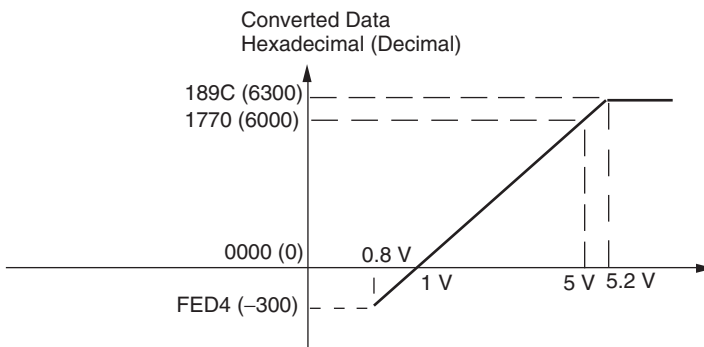

### ● 0 to 20 mA Inputs

When the resolution is set to 1/6,000, the 0 to 20-mA range corresponds to hexadecimal values 0000 to 1770 (0 to 6,000). The entire data range is FED4 to 189C (-300 to 6,300).

A negative voltage is expressed as a two's complement.

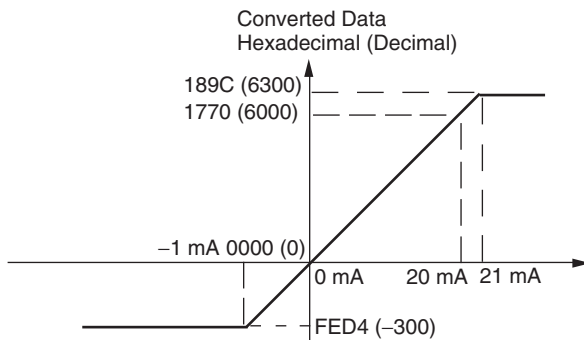

● **4 to 20 mA**

When the resolution is set to 1/6,000, the 4- to 20-mA range corresponds to hexadecimal values 0000 to 1770 (0 to 6,000). The entire data range is FED4 to 189C (-300 to 6,300).

Inputs between 3.2 and 4 mA are expressed as two's complements. If the input falls below 3.2 mA, open-circuit detection will activate and converted data will be 8000.

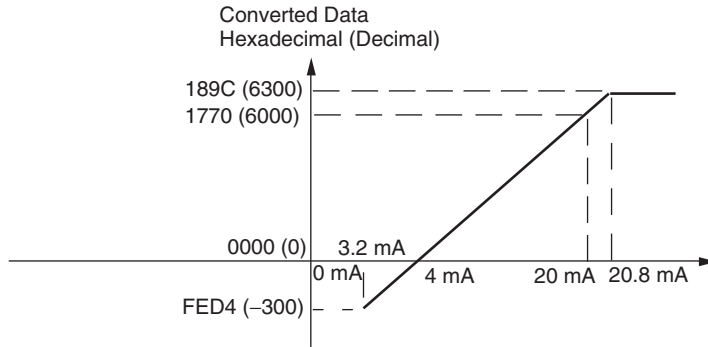

**15-2-2 Analog Output Signal Ranges**

● **-10 to 10 V Outputs**

When the resolution is set to 1/6,000, the hexadecimal values F448 to 0BB8 (-3,000 to 3,000) correspond to an analog voltage range of -10 to 10 V.

Specify a negative voltage as a two's complement.

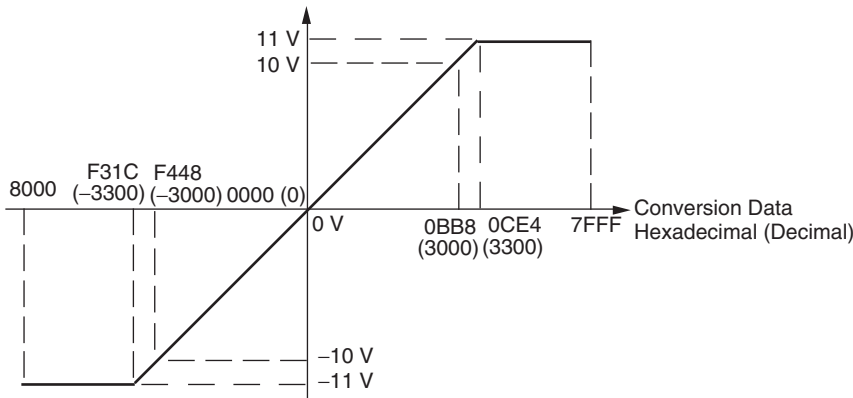

● **0 to 10 V Outputs**

When the resolution is set to 1/6,000, the hexadecimal values 0000 to 1770 (0 to 6,000) correspond to an analog voltage range of 0 to 10 V.

Specify a negative voltage as a two's complement.

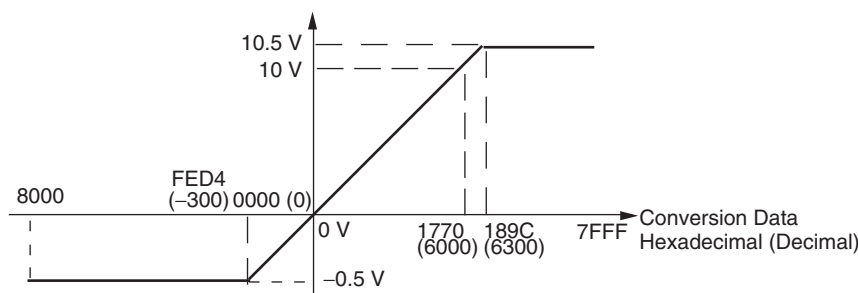

● **0 to 5 V Outputs**

When the resolution is set to 1/6,000, the hexadecimal values 0000 to 1770 (0 to 6,000) correspond to an analog voltage range of 0 to 5 V.

Specify a negative voltage as a two's complement.

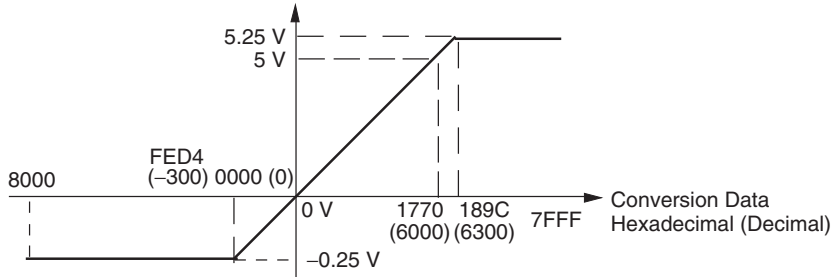

● **1 to 5 V Outputs**

When the resolution is set to 1/6,000, the hexadecimal values 0000 to 1770 (0 to 6,000) correspond to an analog voltage range of 1 to 5 V.

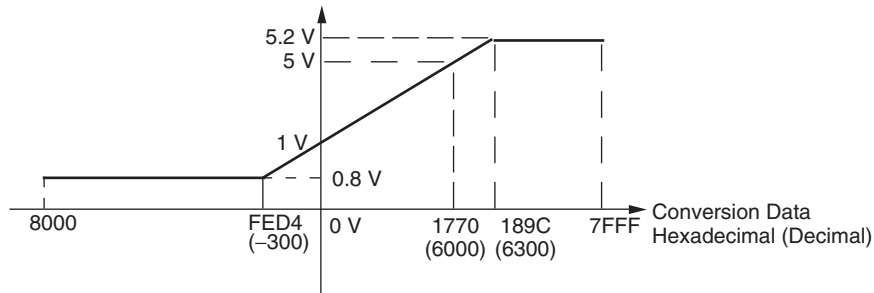

● **0 to 20 mA Outputs**

When the resolution is set to 1/6,000, the hexadecimal values 0000 to 1770 (0 to 6,000) correspond to an analog current range of 0 to 20 mA.

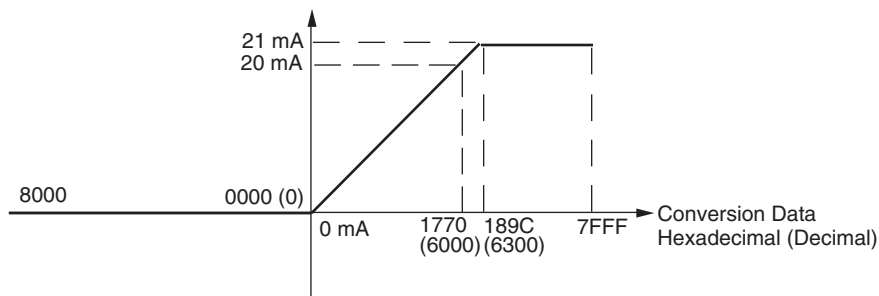

● **4 to 20 mA Outputs**

When the resolution is set to 1/6,000, the hexadecimal values 0000 to 1770 (0 to 6,000) correspond to an analog current range of 4 to 20 mA.

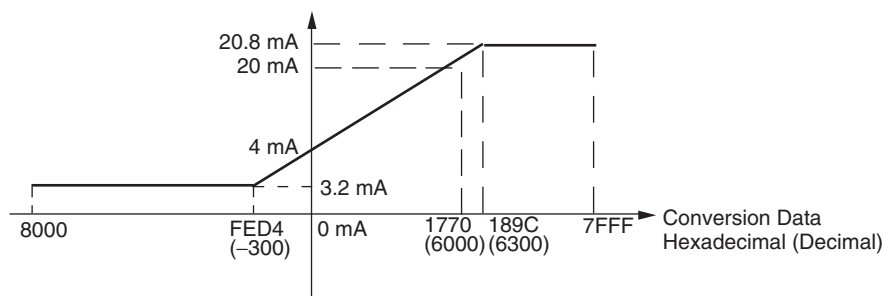

### 15-2-3 Special functions

- **Averaging Function for Analog Inputs**

The averaging function stores the average (a moving average) of the last eight input values as the converted value. Use this function to smooth inputs that vary at a short interval.

Use the CX-Programmer to set the averaging function in the PLC Setup. The averaging function can be set independently for each input.

- **Open-circuit Detection Function for Analog Inputs**

The open-circuit detection function is activated when the input range is set to 1 to 5 V and the voltage drops below 0.8 V, or when the input range is set to 4 to 20 mA and the current drops below 3.2 mA. When the open-circuit detection function is activated, the converted data will be set to 8,000.

The time for enabling or clearing the open-circuit detection function is the same as the time for converting the data. If the input returns to the convertible range, the open-circuit detection is cleared automatically and the output returns to the normal range.

Auxiliary Area bits A434.00 to A434.01 are allocated as open-circuit detection flags.

## 15-3 I/O Allocation and Related Auxiliary Area Flags

### 15-3-1 I/O Allocation

Word	I/O Points	Description	Values
CIO 90	AD0	CIO words that I/O conversion data for AD0 is stored in.	-10V to 10V range: F448 to 0BB8 hex
CIO 91	AD1	CIO words that I/O conversion data for AD1 is stored in.	Other ranges: 0000 to 1770 hex
CIO 190	DA0	CIO words that I/O conversion data for DA0 is stored in.	

### 15-3-2 Related Auxiliary Area Flags

Bit	Name	Description	Values
A434.00	Open-circuit Detection Flags	When analog Input 0 (AD0) open-circuit Error is detected, this bit will be changed to "1".	0: No error 1: Open-circuit error detected
A434.01	Open-circuit Detection Flags	When analog Input 1 (AD1) open-circuit Error is detected, this bit will be changed to "1".	
A434.04	Analog Initialization Completed Flag	The Analog Initialization Completed Flag will be changed to "1" ON when initial processing is completed.  If the system starts operating, use this flag in the program to delay reading converted data from analog inputs until the data is valid.	0: Initializing 1: Initialization completed
A315.14	Built-in Analog Error	When the built-in analog do not work normally, this bit will be changed to "1".	0: No error 1: Built-in analog error

# 16

## Other Functions

This section describes PID temperature control, clock functions, DM backup functions, security functions.

---

<b>16-1 PID Temperature Control</b> .....	<b>16-2</b>
16-1-1 Overview .....	16-2
16-1-2 Flow of Operation .....	16-3
16-1-3 Application Example .....	16-4
<b>16-2 Clock</b> .....	<b>16-7</b>
<b>16-3 DM Backup Function</b> .....	<b>16-8</b>
16-3-1 Backing Up and Restoring DM Area Data .....	16-8
16-3-2 Procedure .....	16-10
<b>16-4 Security Functions</b> .....	<b>16-12</b>
16-4-1 Ladder Program Read Protection .....	16-12
16-4-2 Protecting Program Execution Using the Lot Number .....	16-14

# 16-1 PID Temperature Control

PID temperature control can be used with any model of CP1E CPU Unit.

## 16-1-1 Overview

The CP1E CPU Unit supports PID instructions with the autotuning function. Ladder programs can be written to perform PID temperature control.

- **Temperature input:** Input from Temperature Sensor Unit to words in the Input Area.
- **PID control:** Execute using the PIDAT instruction in ladder program.  
The PIDAT instruction is used in combination with the TPO instruction (TIME-PROPORTIONAL OUTPUT) to perform time-proportional control.
- **Control output:** To connect an SSR, connect a 24-V power supply to the transistor output and output voltage pulses.

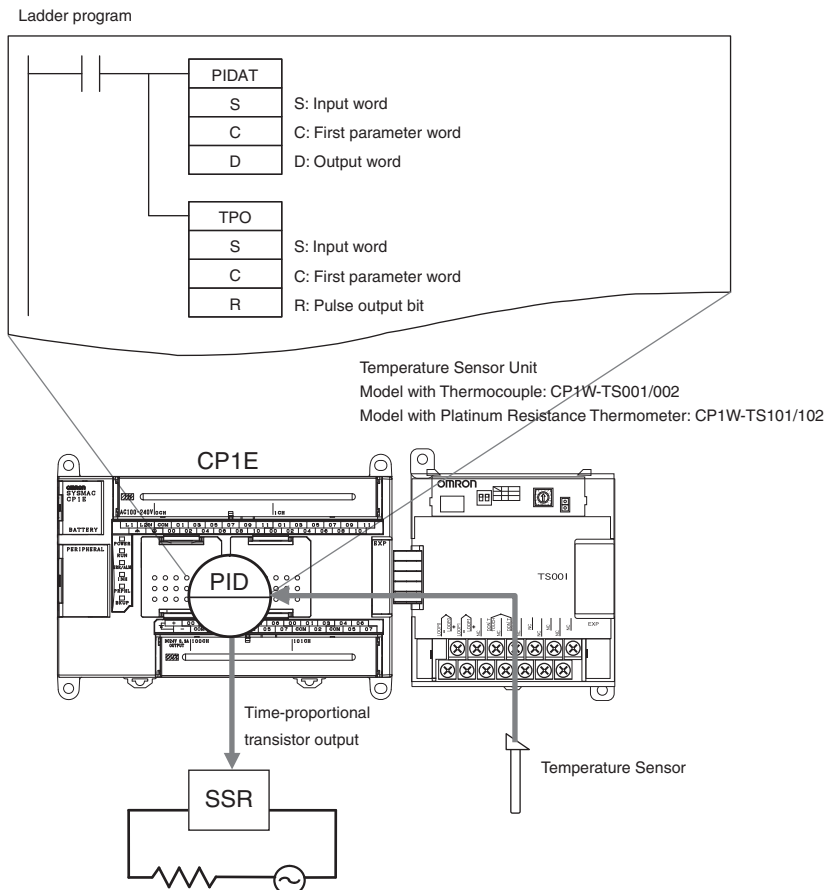

### Additional Information

The sampling cycle set for a PIDAT instruction is between 10 ms to 99.99 s in increments of 10 ms. The actual calculation cycle is determined by the relationship with cycle time. Refer to the *CP1E CPU Unit Instructions Reference Manual* (Cat. No. W483) for the PIDAT instruction.



## 16-1-2 Flow of Operation

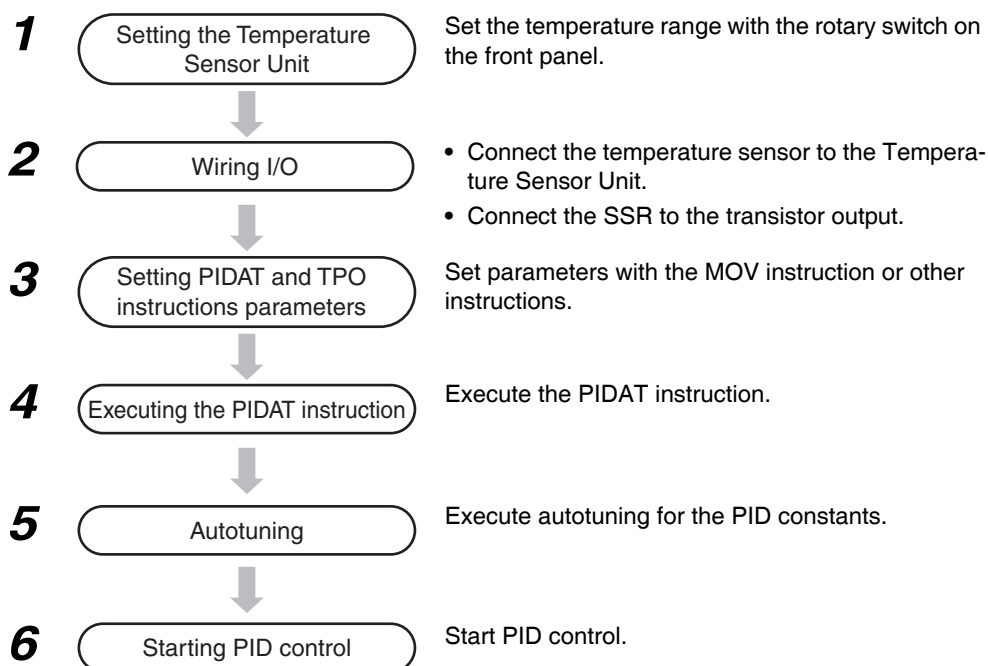

## Inputting the Temperature Sensor's PV to PIDAT Instructions

### ● Temperature Sensor Unit

- Setting the Temperature Range  
Set the temperature range with the rotary switch on the front panel of the Temperature Sensor Unit. If the rotary switch is set to 1 for a CP1W-TS001 Temperature Sensor Unit, the temperature range is 0.0 to 500.0°C.
- Temperature Data Storage Format  
Temperature data is automatically stored in words in the Input Area allocated to the Temperature Sensor Unit as an Expansion Unit using four-digit hexadecimal.  
Example: 100°C is stored as 0064 hex.
  - When the range code is a decimal number to one decimal point, the value is multiplied by a factor of 10 and converted to a hexadecimal number without a sign, then stored as binary data.  
Example: 500.0°C multiplied by 10 is 5000 decimal. This is converted to 1388 in hexadecimal and stored.
  - If the temperature is negative, it is stored as signed hexadecimal.  
Example: -200°C is stored as FF38 hex.

### ● PIDAT Instruction

The PIDAT instruction treats the PV as unsigned hexadecimal data (0000 to FFFF hex). Signed data cannot be used, so if the temperature range includes negative values, apply scaling with the APR instruction.

## Autotuning Procedure

### ● Automatically Executing Autotuning When PIDAT Is Executed

To automatically autotune the PID constants, turn ON the AT Command Bit when the PIDAT instruction is executed.

- 1 Set the PID parameter in words C to C+10. Word C is specified by the second operand.

Example: Place the set value (SV) in C and place the input range in bits 08 to 11 of C+6. Turn ON bit 15 of C+9 (AT Command Bit).

- 2 Turn ON the PIDAT instruction's input condition.

The PIDAT instruction will execute autotuning. When it has finished, the AT Command Bit (bit 15 in C+9) will turn OFF. At the same time the proportional band (C+1), integral constant (C+2), and derivative constant (C+3) calculated by autotuning will be stored and PID control will be started.

### ● Executing Autotuning for Other Conditions When PIDAT Is Executed

Here, the AT Command Bit is left OFF when the PIDAT instruction is being executed. Later it is turned ON by some other condition to start autotuning.

- 1 Set the PID parameter in words C to C+10. Word C is specified by the second operand.

Example: Place the set value (SV) in C, the proportional band in C+1, the integral constant in C+2, the derivative constant in C+3, and the input range in bits 08 to 11 of C+6. Turn OFF bit 15 of C+9 (AT Command Bit).

- 2 Turn ON the PIDAT instruction's input condition. PID control will be started with the specified PID constants.

- 3 Turn ON bit 15 in C+9 (the AT Command Bit) while the input condition for the PID instruction is ON. Autotuning will be performed. When it has finished, the AT Command Bit (bit 15 in C+9) will turn OFF. The proportional band (C+1), integral constant (C+2), and derivative constant (C+3) calculated by autotuning will be stored and PID control will be started with those PID constants.

## 16-1-3 Application Example

### System Configuration

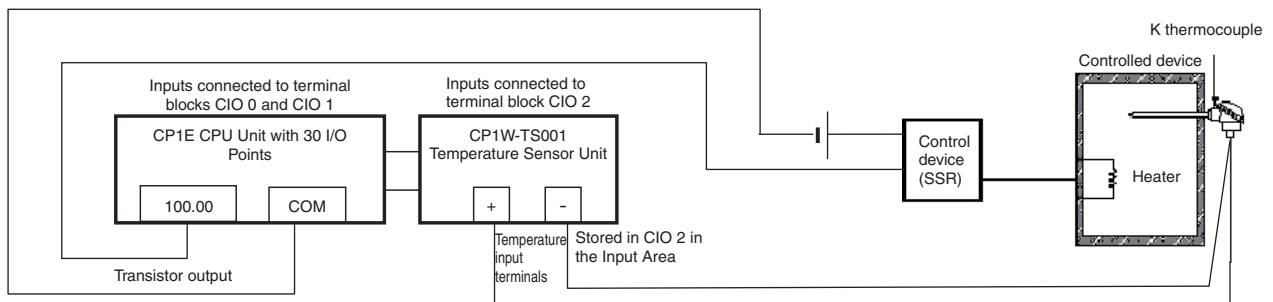

- A K thermocouple is used for the temperature input. Use a CP1W-TS001 Temperature Sensor Unit (thermocouple input).

- The Temperature Sensor Unit's temperature input PV is stored in CIO 2.
- The control output is the transistor output used to control the heater through the SSR using time-proportional control.
- The PIDAT sampling cycle is 1 second.
- Control cycle: 20 s
- When W0.00 turns ON, autotuning is immediately executed and PID control is started with the PID constants calculated by autotuning.

## Ladder Programming Example for an Input Range of -200 to 1300°C for a K Thermocouple

The CP1W-TS001 Temperature Sensor Unit is used with an input type of K -200 to 1300°C (set the rotary switch to 0). The decimal values -200 to 1300°C are converted to signed hexadecimal data (FF38 to 0514 hex) and stored in CIO 2 in the Input Area.

However, the PIDAT instruction can only handle unsigned hexadecimal data as the PV. The value is thus converted from the range FF38 to 0514 to the PIDAT instruction input range of 0000 to 1FFF hex (0 to 8191) using the APR instruction.

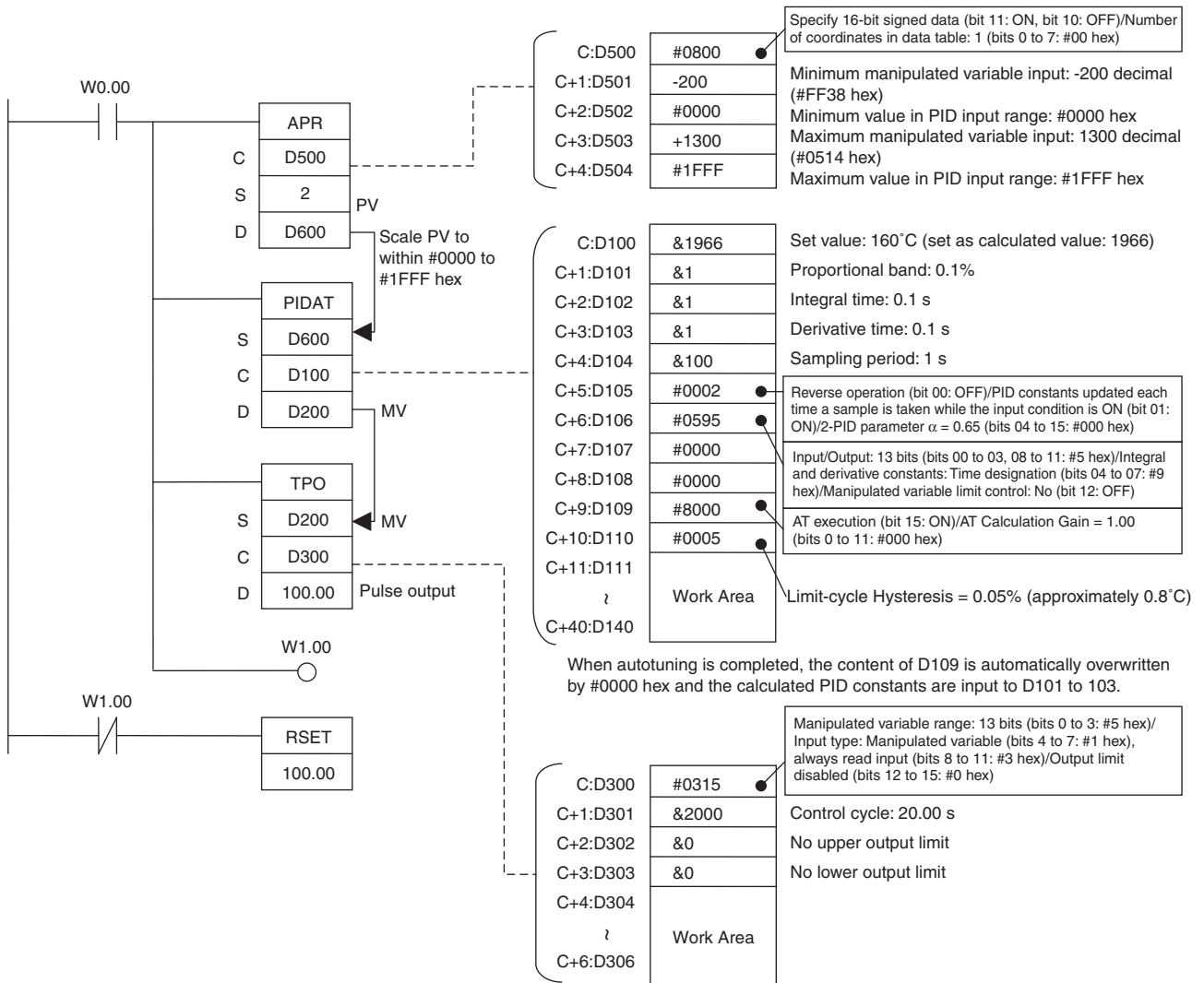

**● Description**

- When W0.00 turns ON, the work area in D111 to D140 is initialized (cleared) according to the parameters set in D100 to D110. After the work area has been initialized, autotuning is started and the PID constants are calculated from the results from changing the manipulated variable. After autotuning has been completed, PID control is executed according to the calculated PID constants set in D101 to D103. The manipulated variable is output to D200. The manipulated variable in D200 is divided by the manipulated variable range using the TPO instruction. This value is treated as the duty factor which is converted to a time-proportional output and output to CIO100.00 as a pulse output.
- When W0.00 turns OFF, PID is stopped and CIO100.00 turns OFF.
- When W0.00 is ON, the Thermocouple's PV (-200 to 1300) is scaled to the PIDAT instruction input range (#0 to #1FFF hex). The set values must be input according to the scaled PV. For example, if the PV is 160°C, it is set as  $[8191/(1300+200)] \times (160+200) = 1966$ .

## 16-2 Clock

The clock can be used only with the CP1E N/NA□□(S)-type CPU Unit.

The current data is stored in the following words in the Auxiliary Area.

Name	Address	Function
Clock data	A351 to A354	The seconds, minutes, hour, day of month, month, year, and day of week are stored each cycle.
	A351.00 to A351.07	Seconds: 00 to 59 (BCD)
	A351.08 to A351.15	Minutes: 00 to 59 (BCD)
	A352.00 to A352.07	Hour: 00 to 23 (BCD)
	A352.08 to A352.15	Day of the month: 01 to 31 (BCD)
	A353.00 to A353.07	Month: 01 to 12 (BCD)
	A353.08 to A353.15	Year: 00 to 99 (BCD)
	A354.00 to A354.07	Day of the week: 00: Sunday, 01: Monday, 02: Tuesday, 03: Wednesday, 04: Thursday, 05: Friday, 06: Saturday



### Additional Information

The clock cannot be used if a battery is not installed or the battery voltage is low.

### ● Related Auxiliary Area Bits and Words

Name	Address	Contents
Start-up Time	A510 and A511	The time at which the power was turned ON (day of month, hour, minutes, and seconds).
Power Interruption Time	A512 and A513	The time at which the power was last interrupted (day of month, hour, minutes, and seconds).
Power ON Clock Data 1	A720 to A722	Consecutive times at which the power was turned ON (year, month, day of month, hour, minutes, and seconds). The times are progressively older from number 1 to number 10.
Power ON Clock Data 2	A723 to A725	
Power ON Clock Data 3	A726 to A728	
Power ON Clock Data 4	A729 to A731	
Power ON Clock Data 5	A732 to A734	
Power ON Clock Data 6	A735 to A737	
Power ON Clock Data 7	A738 to A740	
Power ON Clock Data 8	A741 to A743	
Power ON Clock Data 9	A744 to A746	
Power ON Clock Data 10	A747 to A749	
Operation Start Time	A515 to A517	The time that operation started (year, month, day of month, hour, minutes, and seconds).
Operation End Time	A518 to A520	The time that operation stopped (year, month, day of month, hour, minutes, and seconds).

### ● Time-related Instructions

Name	Mnemonic	Function
CALENDAR ADD	CADD	Adds time to the calendar data in the specified words.
CALENDAR SUBTRACT	CSUB	Subtracts time from the calendar data in the specified words.
CLOCK ADJUSTMENT	DATE	Changes the internal clock setting to the setting in the specified source words.

## 16-3 DM Backup Function

This section describes the function that saves specified words from the DM Area in the built-in EEPROM backup memory.

### 16-3-1 Backing Up and Restoring DM Area Data

#### Overview

The contents of the DM Area (D) will become unstable if the power supply is interrupted for longer than the backup time of the built-in capacitor (50 hours for an E□□(S)-type CPU Unit, 40 hours for an N/NA□□(S)-type CPU Unit without a Battery). The contents of the specified words in the DM Area data can be backed up from RAM to the built-in EEPROM backup memory during operation by turning ON a bit in the Auxiliary Area. The number of DM Area words to back up is specified in the *Number of CH of DM for backup* Box in the PLC Setup. If the *Restore D0- from backup memory* Check Box is selected in the PLC Setup, the backup data will automatically be restored to RAM when the power is turned back ON so that data is not lost even if power is interrupted.

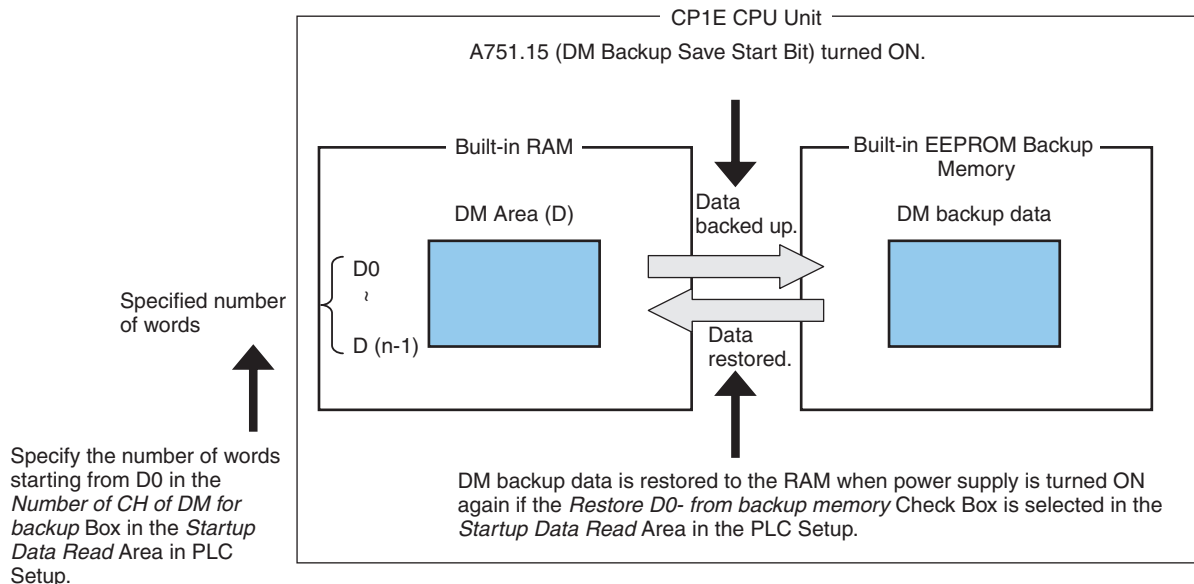

#### ● Conditions for Executing Backup

Specified words starting from D0 in the built-in RAM can be saved to the built-in EEPROM backup memory by turning ON A751.15. (These words are called the DM backup words and the data is called the DM backup data.) A751.15 (DM Backup Save Start Bit) can be used in any operating mode (RUN, MONITOR, or PROGRAM mode).

#### ● Words that can be Backed Up

- E□□(S)-type CPU Units: D0 to D1499
- N/NA□□(S)-type CPU Units: D0 to D6999

### ● Number of Words to Back Up

The number of words to back up starting from D0 is set in the *Number of CH of DM for backup Box in the Startup Data Read Area in the PLC Setup*.

### ● Restoring DM Backup Data to the Built-in RAM When Power is Turned ON

The DM backup data can be restored to the built-in RAM when power is turned ON by selecting the *Restore D0- from backup memory Check Box in the Startup Data Read Area in the PLC Setup*.

The DM backup data will be read from the backup memory even if the *Clear retained memory area (HR/DM/CNT) Check Box* is selected in the PLC Setup.

### ● Related Auxiliary Area Bits

Name	Address	Description
DM Backup Save Start Bit	A751.15	<p>The number of words in the DM Area specified in the <i>Number of CH of DM for backup Box in the Startup Data Read Area in the PLC Setup</i> are saved from the built-in RAM to the built-in EEPROM backup memory when this bit is turned ON.</p> <p>This bit will not automatically turn OFF again if the bit turns ON. Design the ladder program so that this bit is turned ON and OFF again using upwardly differentiated bits.</p> <p>If this bit is turned ON and OFF while the DM Backup Save Flag (A751.14) is ON, it will be ignored and the data will not be backed up again. To backup the data again, make sure that A751.14 is OFF and then turn ON A751.15. A751.15 is turned OFF when the power supply is turned ON.</p>
DM Backup Save Flag	A751.14	<p>This flag turns ON when A751.15 is turned ON to start the saving operation. This flag stays ON while data is being saved and turns OFF when finished.</p> <p>Use this flag to confirm when the DM backup operation has been completed.</p> <p>The flag is turned OFF when the power supply is turned ON.</p>
DM Backup Restore Failed Flag	A751.11	<p>This flag turns ON if the DM backup data could not be restored correctly. If this flag turns ON, data will not be read from the built-in EEPROM backup memory to the RAM.</p> <p>For example, if power was interrupted while data was being backed up, the DM Area data would not be backed up properly and the next time power is turned ON, the DM backup data will not be restored. If this happens, this flag will be turned ON.</p> <p>If the number of the backed up DM area words is different from the <i>Number of CH of DM for backup</i> in the PLC Setup, this flag will be turned ON.</p> <p>This flag turns OFF in the following cases:</p> <ul style="list-style-type: none"> <li>• Data is successfully restored from the built-in EEPROM backup memory to the RAM when the power supply is turned ON.</li> <li>• All memory is cleared.</li> </ul>

### 16-3-2 Procedure

Perform the following procedure to save the DM data to the built-in EEPROM backup memory during operation or while stopped.

- 1 Check the *Restore D0- from backup memory* Check Box in the *Startup Data Read* Area of the PLC Setup from the CX-Programmer.  
Also, set the number of words to be backed up starting from D0 in the *Number of CH of DM for backup* Box. Transfer the PLC Setup to the CPU Unit and turn ON the power supply.



- 2 Turn ON A751.15 (DM Backup Save Start Bit) from the CX-Programmer, a Programmable Terminal (PT), or a ladder program.  
The specified number of words in the DM Area starting from D0 will be backed up to the built-in EEPROM backup memory.

- Using a Ladder Program

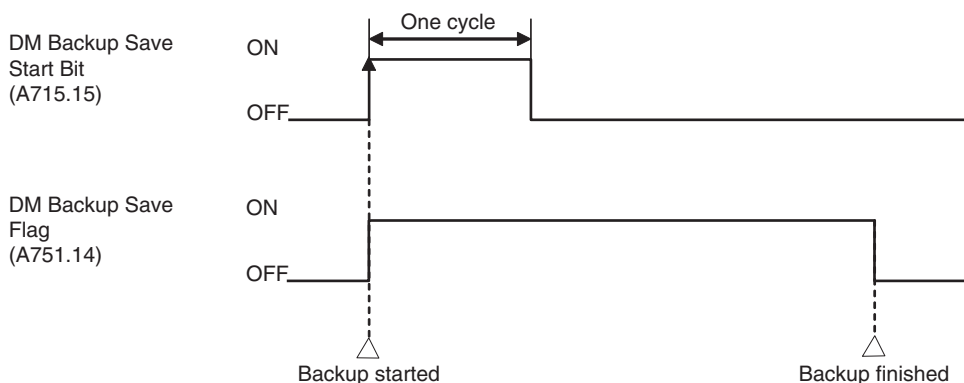
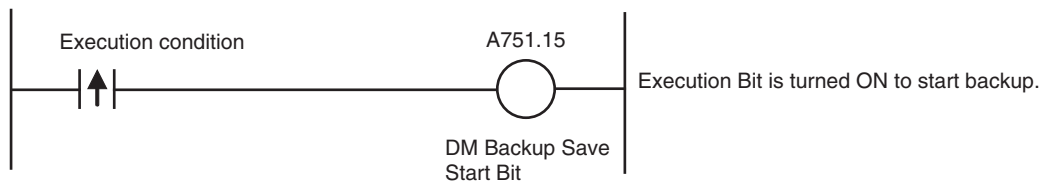

When the saving operation has been completed, A751.14 (DM Backup Save Flag) will turn OFF.





### Precautions for Safe Use

#### Power Interruptions during Backup

The BKUP indicator on the front of the CPU Unit will be lit when DM Area data is being saved to the built-in EEPROM backup memory.

Do not turn OFF the power supply to the PLC while the indicator is lit. If the power supply to the PLC is turned OFF while the BKUP indicator is lit, data will not be backed up. In this case, the DM Backup Restore Failed Flag (A751.11) will turn ON when the power supply is turned ON again. Therefore, the backup data will not be restored to the DM Area. Transfer the data from the CX-Programmer to the DM Area again.



### Precautions for Correct Use

- To prevent operation from starting if the DM backup data is not restored correctly when the power supply is turned ON, insert the following instructions into the ladder program to generate a fatal error.

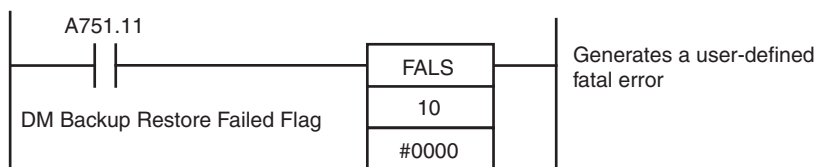

- To ensure concurrency between DM backup data and the contents of the DM Area in the RAM, use exclusive processing in the ladder program so that contents of the DM Area words in the RAM that are set to be backed up are not changed during a backup operation.

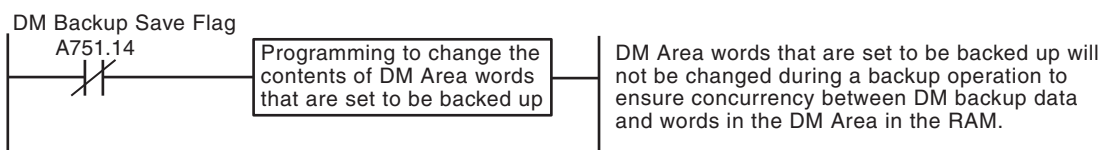

- Data can be written up to 100,000 times to the built-in EEPROM backup memory. Data cannot be written once this limit is exceeded. If writing fails, A315.15 (Backup Memory Error Flag) will turn ON.



### Additional Information

#### Confirming Completion of DM Area Backup

If user programs or the parameter area is being saved to the backup memory using operations from the CX-Programmer, the backup operation will not be executed immediately even if A751.15 (DM Backup Save Start Bit) is turned ON. A751.14 (DM Backup Save Flag) will remain ON during this time and turn OFF when the DM backup operation has been completed. You can confirm the completion of DM backup by checking to see if the DM Backup Save Flag (A751.14) has been turned OFF.

## 16-4 Security Functions

The Security function can be used with any model of CP1E CPU Unit.

### 16-4-1 Ladder Program Read Protection

#### Read Protection

With the CX-Programmer, it is possible to set read protection using a password for the whole ladder program.

When the program is read-protected using a password, it is not possible to display or edit any of the ladder programs using the CX-Programmer unless the password is entered in the Disable Password Dialog Box from the CX-Programmer.

This enables improved security for PLC data in equipment.

#### ● Read Protection Using Extended Passwords

With unit version 1.3 or later and CX-Programmer version 9.6 or higher, you can extend protection with UM read protection to ensure better protection for your design assets. Also, if the password is incorrect five times in a row, a password cannot be entered for two hours.

#### ● Setting Protection

- 1 Right-click the PLC in the project tree to open the **Protection** Tab Page of the **PLC Properties**.

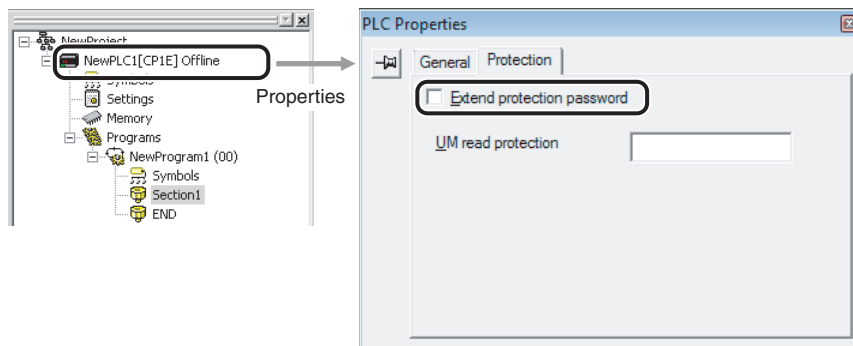

- 2 Set any password.
- 3 Select **Protection-Setting** from the PLC Menu.
- 4 Confirm that the setting item is checked, then click the **OK** button.

- Extend Password Protection

With unit version 1.3 or later and CX-Programmer version 9.6 or higher, you can use longer passwords for UM read protection. Click the *Protection* Tab in the PLC Properties Dialog Box, select the *Extend protection password* Check Box, and enter the passwords.

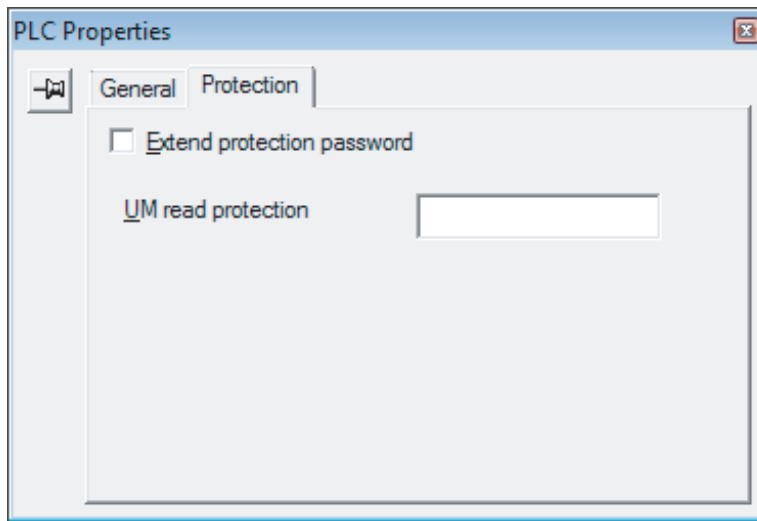

The limits to the password text string lengths are given in the following table.

Unit version	Number of input characters	Type of input characters
Unit version 1.2 or earlier	8 characters max.	Alphanumeric characters
Unit version 1.3 or later	16 characters max.	

- Protection Release Procedure

- 1 Go online and select **Protection - Release Password** from the PLC menu. The Release Read Protection Dialog Box will be displayed.

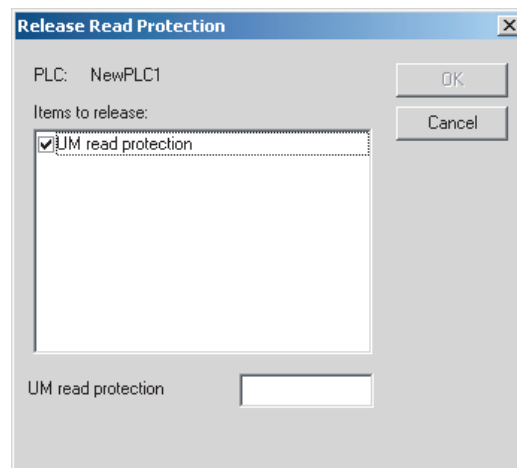

- 2 Enter the registered password.

If the password is incorrect, the message shown on the right will be displayed, and protection will not be released.

If incorrect passwords are entered for five consecutive attempts, the CPU Unit does not accept any more passwords for two hours.

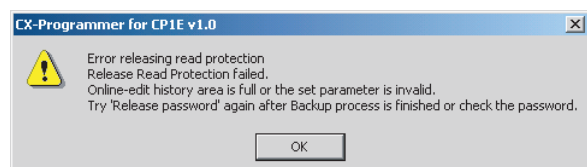

● **Auxiliary Area Bits Related to Password Protection**

Name	Bit address	Description	Status after mode change	Startup hold settings
UM Read Protection Status	A99.00	Indicates whether or not the whole ladder programs are read-protected. OFF: UM read protection is not set. ON: UM read protection is set.	Hold	Hold

**16-4-2 Protecting Program Execution Using the Lot Number**

● **Overview**

The lot number is stored in words A310 and A311 of the CP1E CPU Unit's Auxiliary Area. These words generate a fatal error to prevent a user program from running on a PLC with a different production lot number. In addition, by setting passwords, you can prohibit loading of programs, and thereby prohibit copying of user programs. The lot number cannot be changed by the user.

- The upper digits of the lot number are stored in A311 and the lower digits are stored in A310, as shown below.

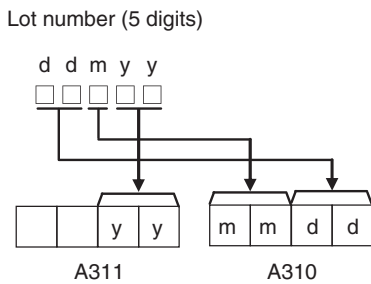

- X, Y, and Z in the lot number are converted to 10, 11, and 12, respectively, in A310 and A311.

● **Programming Example**

- (1) The following instructions will create a fatal error to prevent the program from being executed when the lot number is not 23905.

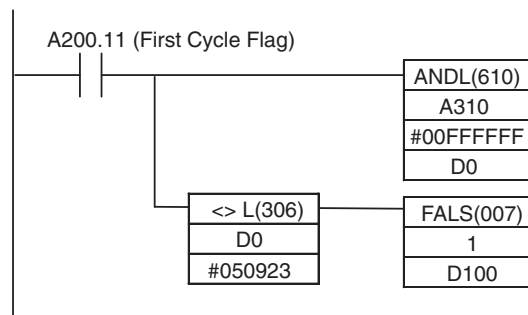

- (2) The following instructions will create a fatal error to prevent the program from being executed when the lot number does not end in 05.

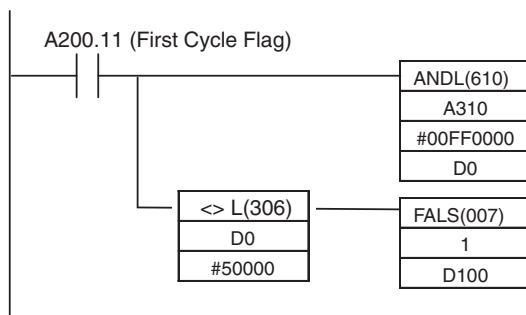

- (3) The following instructions will create a fatal error to prevent the program from being executed when the lot number does not begin with 23Y.

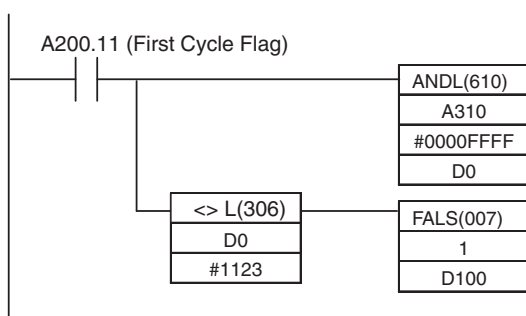



# 17

## Ethernet Option Board

This section gives an overview of the Ethernet Option Board, describes its setting methods, I/O memory allocations, troubleshooting, how to connect the CX-Programmer, and how to install an Ethernet network.

<b>17-1 Features and Specifications</b>	<b>17-2</b>
17-1-1 Ethernet Option Board Function Guide	17-2
17-1-2 Features	17-3
17-1-3 Specifications	17-5
17-1-4 Software Configuration	17-5
17-1-5 FINS Communications	17-6
17-1-6 Differences in version of the Ethernet Option Board	17-8
<b>17-2 Startup Procedure</b>	<b>17-9</b>
17-2-1 Startup Procedure	17-9
<b>17-3 Settings</b>	<b>17-11</b>
17-3-1 Ethernet Option Board Setup	17-11
17-3-2 Transferring Data from the CPU Unit	17-12
17-3-3 Default Settings	17-13
17-3-4 Web Browser Setting Function	17-15
<b>17-4 Memory Allocations</b>	<b>17-26</b>
17-4-1 DM Area Allocation	17-26
17-4-2 CIO Area Allocation	17-31
<b>17-5 Trouble Shooting</b>	<b>17-33</b>
17-5-1 Error Log	17-33
17-5-2 Error Codes	17-34
17-5-3 Error Status	17-36
<b>17-6 Connection Method with the CX-Programmer</b>	<b>17-37</b>
<b>17-7 Network Installation</b>	<b>17-40</b>
17-7-1 Devices Required for Constructing a Network	17-40
17-7-2 Network Installation	17-40
<b>17-8 Comparison with Previous Models</b>	<b>17-42</b>
<b>17-9 Buffer Configuration (CP1W-CIF41)</b>	<b>17-43</b>

# 17-1 Features and Specifications

## 17-1-1 Ethernet Option Board Function Guide

### Overall system configuration example

Ethernet Option Board provides receiving commands by OMRON standard protocol FINS for CP1E programmable controllers. The Ethernet Network Interface allows you to easily connect CP1E Programmable Controllers onto new or existing Ethernet network and upload/download programs, communicate between controllers (do not support real-time scanning I/O on Ethernet Option Board).

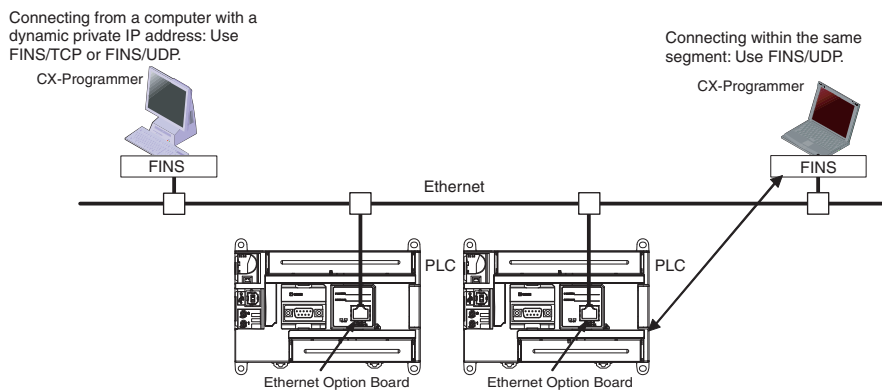

- Note 1** Please use CX-Programmer version 9.12 or higher (CX-ONE version 4.1 or higher).  
**2** Use the Web browser to set the CP1W-CIF41.  
**3** NS-series HMI cannot use CP1W-CIF41 through Ethernet.

### Connecting the CX-Programmer to PLCs Online via Ethernet

#### ● Connecting within the Same Segment

Use the UDP/IP version of the FINS communications service (i.e., FINS/UDP). FINS/UDP is supported by many OMRON products and is compatible with earlier Ethernet Units (CS1W-ETN01/ETN11/ETN21 and CJ1W-ETN11/ETN21). The CX-Programmer can be connected and used with FINS/UDP.

#### ● Connecting through Multiple Segments

Use the TCP/IP version of the FINS communications service (i.e., FINS/TCP). It provides automatic recovery at the TCP/IP layer from communications errors (such as packet loss) that occur during multilevel routing. For CX-Programmer, FINS/TCP can be used to directly connect to the PLC online.

#### ● Using Media with Unreliable Connections, Such as a Wireless LAN

Use the TCP/IP version of the FINS communications service (i.e., FINS/TCP). It provides automatic recovery at the TCP/IP layer from communications errors (such as packet loss) resulting from unreliable connections. For CX-Programmer, FINS/TCP can be used to directly connect to the PLC online.



### ● Connecting from a Personal Computer with a Dynamic Private IP Address

Depending on whether or not the connection will be within the same segment, either use an IP address conversion method for dynamic IP addresses in the UDP/IP version of the FINS communications service or use the TCP/IP version of the FINS communications service.

It is possible to connect online to a PLC using the CX-Programmer from a computer serving as a temporarily connected node or a permanent DHCP client.

For CX-Programmer, FINS/TCP can be used to directly connect to the PLC online.

## Receiving Data from OMRON PLCs using Ethernet

The CP1W-CIF41 Ethernet Option Board can only support receiving FINS commands from OMRON PLCs using Ethernet.

**Note** The SEND(090), RECV(098) and CMND(490) instructions cannot be used in the CP1E CPU Unit .

### ● Connecting within the Same Segment

Use the UDP/IP version of the FINS communications service (i.e., FINS/UDP), and construct applications using the SEND(090), RECV(098), and CMND(490) instructions in the ladder program. FINS/UDP is supported by many OMRON products, and is compatible with earlier Ethernet Units (CS1W-ETN01/ETN11/ETN21 and CJ1W-ETN11/ETN21). The protocol processing for FINS/UDP is simpler than for FINS/TCP, giving FINS/UDP certain advantages in terms of performance. Another feature of FINS/UDP is that it can be used for broadcasting.

On the other hand, with FINS/UDP it is necessary to provide measures, such as retries, for handling communications errors.

### ● Connecting through Multiple Segments

Use the TCP/IP version of the FINS communications service (i.e., FINS/TCP), and construct applications using the SEND(090), RECV(098), and CMND(490) instructions in the ladder program. FINS/TCP is the initial function supported by this Ethernet Option Board (CP1W-CIF41). It provides automatic recovery at the TCP/IP layer from communications errors (such as packet loss) that occur during multilevel routing.

## 17-1-2 Features

### Compatibility and Speed

The transmission medium of Ethernet side has been upgraded to 100Base-TX, while compatibility with some functions and application interfaces of the existing Ethernet Unit models for CS/CJ series has been maintained.

Limited by the Host Link protocol used on the serial side, the processing speed is only 115.2kbps, slower than the existing Ethernet Unit. The FINS frame length is less than 540 bytes, so the system response performance for the same FINS message applications is longer than the existing Ethernet Unit.

## Various Protocols Available on Ethernet

---

A variety of protocols make a wide range of applications for use on an Ethernet network. The protocols that can be selected include receiving commands by OMRON's standard protocol FINS and reading Ethernet Option Board settings and status by HTTP.

A communications service can be selected according to need, allowing the PLC to be flexibly integrated with the Ethernet information network.

## Improved FINS Message Communications

---

The following functions have been maintained according to the existing Ethernet Unit models for CS/CJ series.

- The maximum number of nodes is 254.
- Communications are enabled even if the host computer's IP address is dynamic.
- An automatic client FINS node address allocation function makes it possible to connect online to the PLC even if no FINS node address has been set for the host computer.
- FINS message communications is enabled in both UDP/IP and TCP/IP, but it is only enabled in TCP/IP with up to 2 simultaneous connections (only used as server).  
→**Previously** it is enabled in TCP/IP with up to 16 simultaneous connections and **all can be set to client**.
- Multiple FINS applications, such as the CX-Programmer, on the same computer can be connected online to the PLC via Ethernet.

## Use Web Function to Read Ethernet Option Board Settings and Status

---

A Web function is provided in Ethernet Option Board.

This enables use of a Web browser to read the Ethernet Option Board's system settings and statuses.

## Full Range of Functions for Handling Troubles

---

A full range of functions is provided for promptly handling any troubles.

- Self-diagnostic function when power is turned ON.
- Error log for recording error information when an error occurs.

### 17-1-3 Specifications

Item		Specifications		
Name		CP-series Ethernet Option Board		
Model number		CP1W-CIF41		
Type		100Base-TX (Can be used as 10 Base-T )		
Applicable Programming Device		CX-Programmer version 9.12 or higher		
Unit classification		CP-series Option Board		
Mounting location		One slot for a CP-series Option Board		
Size of Buffers		8K bytes		
Transfer	Media access method	CSMA/CD		
	Modulation method	Baseband		
	Transmission paths	Star form		
	Baud rate	100 Mbit/s (100Base-TX)	10 Mbit/s (10Base-T)	
		However, the internal baud rate between the CPU Unit and the Ethernet Option Board is 115.2 kbps.		
	Transmission media	<ul style="list-style-type: none"> <li>Unshielded twisted-pair (UDP) cable Categories: 5, 5e</li> <li>Shielded twisted-pair (STP) cable Categories: 100Ω at 5, 5e</li> </ul>	<ul style="list-style-type: none"> <li>Unshielded twisted-pair (UDP) cable Categories: 3, 4, 5, 5e</li> <li>Shielded twisted-pair (STP) cable Categories: 100Ω at 3, 4, 5, 5e</li> </ul>	
		Transmission Distance	100 m (distance between hub and node)	
Number of cascade connections	No restrictions if switching hubs are used.			
Weight		23 g max.		
Dimensions		36.4×36.4×28.2 mm (W×H×D)		

**Note** CP1W-CIF41 only support 32 bytes PING command. If PING command's length is larger than 32 bytes, there is no response.

### 17-1-4 Software Configuration

The software supported by the Ethernet Option Board runs in the layers shown in the following diagram.

It is necessary to set the communications settings before connecting the Ethernet Option Board to the CP1E CPU Unit by the Host Link protocol. Refer to *Serial Communications Settings of the Option Board* in section 17-2-1.

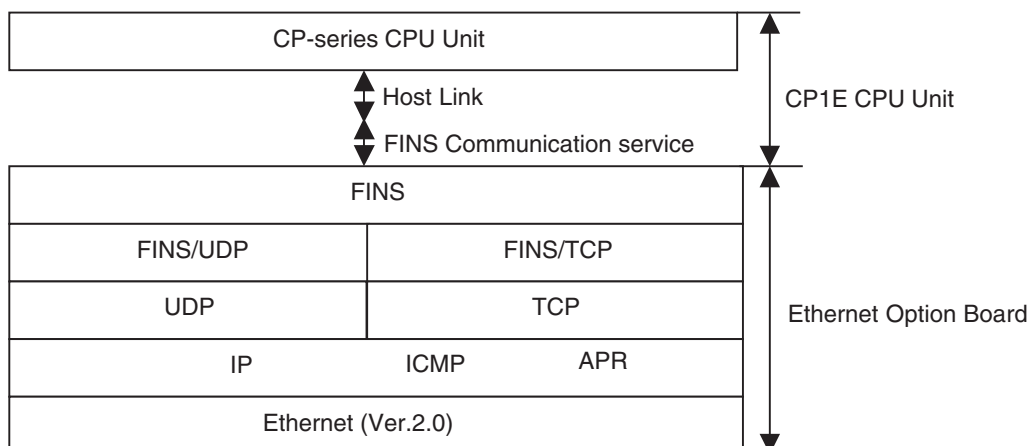

## 17-1-5 FINS Communications

### Overview of FINS Communication Service

#### ● Basic Functions

FINS commands can be received from other PLCs or computers on the same Ethernet network by executing SEND(090), RECV(098), or CMND (490) instructions in the ladder diagram program. This enables various control operations such as the reading and writing of I/O memory between PLCs, mode changes, and file memory operations.

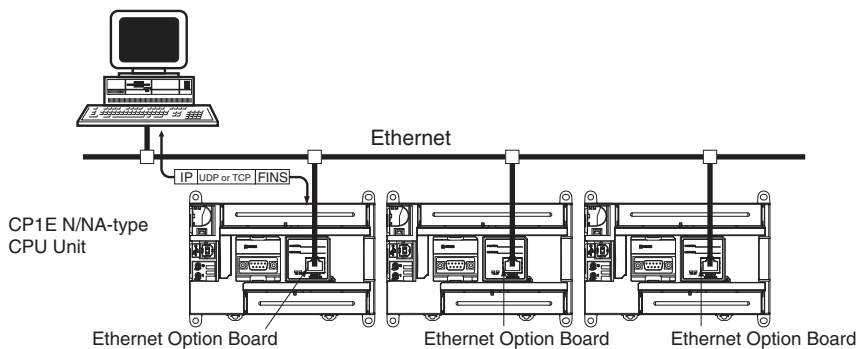

Executing, from the host computer, FINS commands with UDP/IP or TCP/IP headers enables various control operations, such as the reading and writing of I/O memory between PLCs, mode changes, and file memory operations.

For example, it is possible to connect online via Ethernet from FINS communications applications such as the CX-Programmer, and to perform remote programming and monitoring.

#### ● Upgraded Functions

With the CP1W-CIF41, the following functions have been upgraded.

- The FINS communications service can be executed not only with UDP/IP but also with TCP/IP, and it is even possible to use FINS communications with both UDP/IP and TCP/IP together on the same network. Using TCP/IP makes FINS communications highly reliable.
- Even if the IP address and UDP port number of the host computer (a DHCP client computer) are changed, it is still possible for the host computer to send FINS commands to PLCs on the Ethernet network and to receive responses. When UDP is used, either the automatic generation (dynamic) method or the IP address table method must be selected for IP address conversion. When TCP is used, changes in IP address and TCP port numbers are handled automatically.
- Multiple FINS applications (CX-Programmer and user-created application programs) at the same computer can be connected online to a PLC via Ethernet (using either TCP/IP or UDP/IP).

**Note** The message service does not guarantee that a message will reach the destination node. A message may be lost during transmission due to factors such as noise. To prevent this from occurring when using message services, it is common to set up retry processing at the node from which instructions are issued. With the SEND(090), RECV(098), and CMND(490) instructions, retry processing is executed automatically by specifying the number of retries, so specify a number other than 0.

## FINS Communications Service Specifications

Item	Specification	
Number of nodes	254	
Message length	552 bytes max.	
Date length	540 bytes max. (FINS header 10 bytes and command code 2 bytes is not included)	
Number of buffer	8K bytes	
Protocol name	FINS/UDP method	FINS/TCP method
Protocol used	UDP/IP	TCP/IP
	The selection of UDP/IP or TCP/IP is made from the FINS/TCP Tab by the Web browser function.	
Server/Client	Only server (Cannot be used as a client)	
Number of connections	---	2
Port number	9600 (default)	9600 (default)
	Can be changed.	Can be changed.
Protection	No	Yes (Specification of client IP addresses)
Default local FINS node address	1	
Default local IP address	192.168.250.1	
Other	Items set for each UDP port	Items set for each connection
	<ul style="list-style-type: none"> <li>Broadcast</li> <li>Address conversion method</li> </ul>	<ul style="list-style-type: none"> <li>Server specification</li> <li>Remote IP address spec. Server: specify IP addresses of clients permitted to connect.</li> <li>Automatic FINS node address allocation Specify automatic allocation of client FINS node addresses</li> </ul>
Internal table	<p>This is a table of correspondences for remote FINS node addresses, remote IP addresses, TCP/UDP, and remote port numbers. It is created automatically when power is turned ON to the PLC or when the unit is restarted, and it is automatically changed when a connection is established by means of the FINS/TCP method or when a FINS command received.</p> <p>The following functions are enabled by using this table.</p> <ul style="list-style-type: none"> <li>IP address conversion using the FINS/UDP method</li> <li>Automatic FINS node address conversion after a connection is established using the FINS/TCP method</li> <li>Automatic client FINS node address allocation using the FINS/TCP method</li> <li>Simultaneous connection of multiple FINS applications</li> </ul>	

**Precautions for Correct Use**

The differences between the Ethernet Option Board and the CS/CJ series Ethernet Unit are as follows.

- Connect with the CPU Unit by the Host Link (serial communications) whose internal baud rate is 115.2 kbps.
- The size of communications buffers is 8K bytes, one fifty of that of the CS/CJ series Ethernet Unit.

Therefore, the communication performance is slower than the CS/CJ series Ethernet Unit.

Refer to the following processing time (Network delay is not included), when accessing to the CP-series CPU Unit through the Ethernet Option Board.

When accessing to the CP1E CPU Unit and reading 269 words from the DM area, if the cycle time of the CPU Unit is 10 ms, the processing time will be more than 225 ms and less than 356 ms.

For the CS/CJ series CPU Unit who installs the Ethernet Unit, when executing the same task, the processing time will be approximately 20 ms, up to 17 times faster.

**17-1-6 Differences in version of the Ethernet Option Board**

CP1W-CIF41 Ethernet Option Board has two versions: version 1 and version 2. Only version 2 can be used on the CP1E CPU Unit.

**Comparison with CP1W-CIF41 Version 1.0**

Item	CP1W-CIF41 version 1.0	CP1W-CIF41 version 2.0
Communications mode	Toolbus (CP1L/CP1H)	Toolbus (CP1L/CP1H) Host Link (CP1E)
Reset system settings function	Not supported	Turn ON the Reset Flag A525.01 in the Auxiliary Area.
Restart function	Click the Restart Button from the Web browser.	<ul style="list-style-type: none"> <li>• Click the Restart Button from the Web browser.</li> <li>• Turn ON the Restart Flag A525.09 in the Auxiliary Area.</li> </ul>
Max. number of units that can be mounted	Cannot be used	1 set

The CP1E CPU Unit does not support the Toolbus protocol, so the Ethernet Option Board version 1.0 cannot be used.

# 17-2 Startup Procedure

## 17-2-1 Startup Procedure

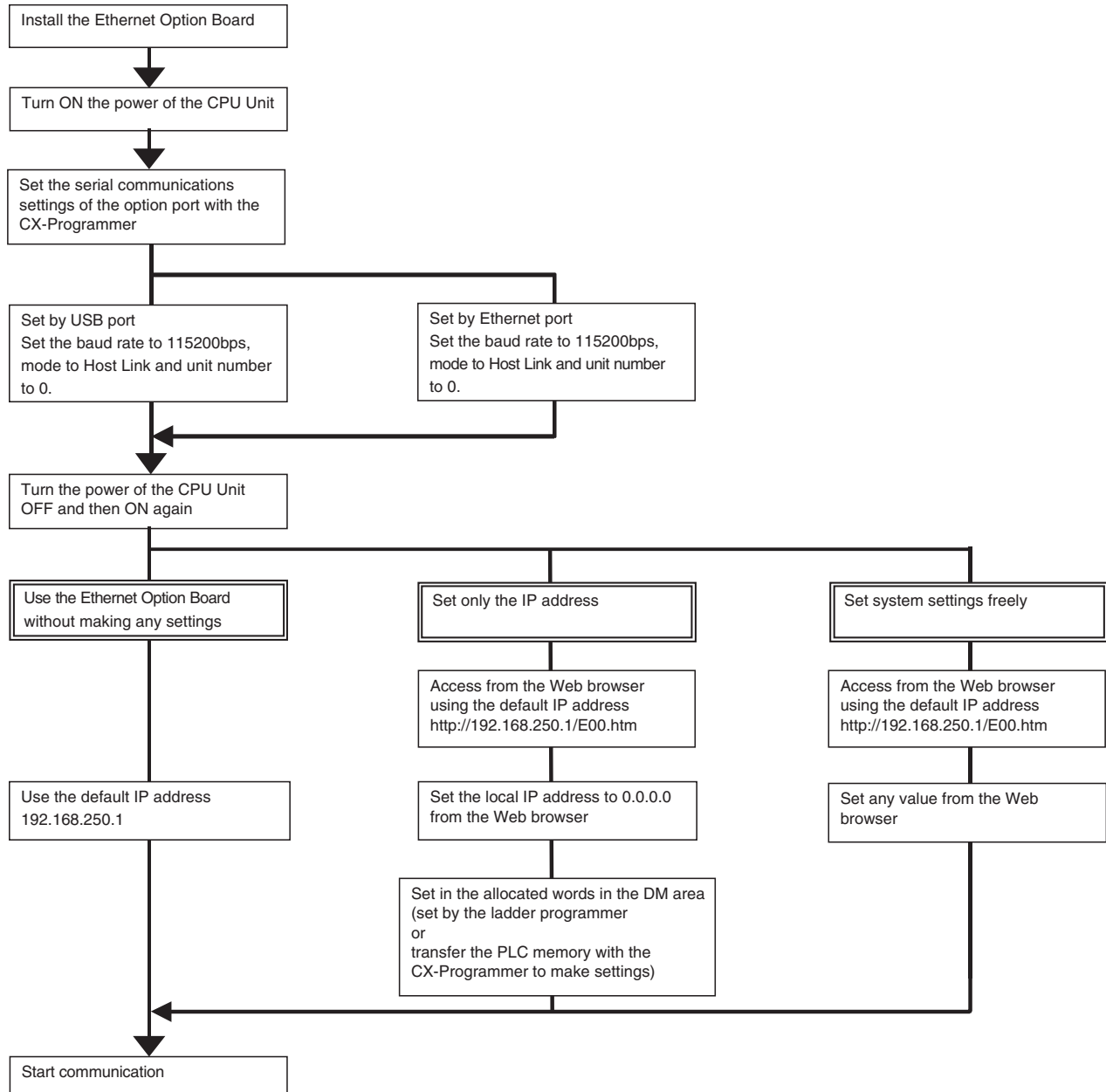

## Serial Communications Settings of the Option Board

To make the settings of the Ethernet Option Board, firstly, it is necessary to set the serial communications settings of the CPU Unit. It can be set by the following two methods.

1. Set by the USB port of the CPU Unit
2. Set by the Ethernet port of the Ethernet Option Board

For details on the method of connecting the CX-Programmer to the Ethernet option port, refer to *17-6 Connection Method with the CX-Programmer*.

Connect the CX-Programmer to the CPU Unit, and then change the PLC Settings as follows.

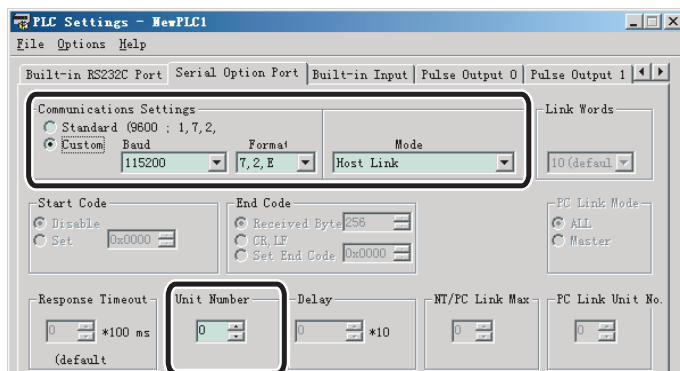

Serial Option Port Tab Page

Parameter	Setting
Communications Settings	Select the <i>Custom</i> option, set the baud rate to <i>115200</i> and the format to <i>7,2,E</i> .
Mode	Select <i>Host Link (default)</i> or <i>Host Link</i> .
Unit Number	Select <i>0</i> .



### Precautions for Correct Use

When the Ethernet Option Board is applied on the CP1E CPU Unit, it is necessary to set the baud rate to 115,200 and the mode to Host Link.

At the following settings, ERR LED of the Ethernet Option Board will be flashing.

Check and change the settings. (It is possible to change settings either by USB or by Ethernet.)

- Baud rate: 9,600
- Unit number: Except 0

However, except the settings mentioned above, ERR LED will be lit if the communications is impossible between the CPU Unit and the Ethernet Option Board. Check and change the settings.

If setting the mode to Host Link and the baud rate to any value except 9,600 or 115,200, the CP1E CPU Unit cannot be connected with Ethernet. Change the PLC Settings by USB.

When changing baud from 9600 to 115k by CP1W-CIF41, ensure that the timeout setting of CX-Programmer is enough.



# 17-3 Settings

## 17-3-1 Ethernet Option Board Setup

The Ethernet Option Board's system settings can be set using the Web browser of a personal computer or other devices connected with Ethernet. The setting values are saved in the Ethernet Option Board's EEPROM.

The settings will be read from the allocated words when the power of the CP1E CPU Unit is turned ON again.

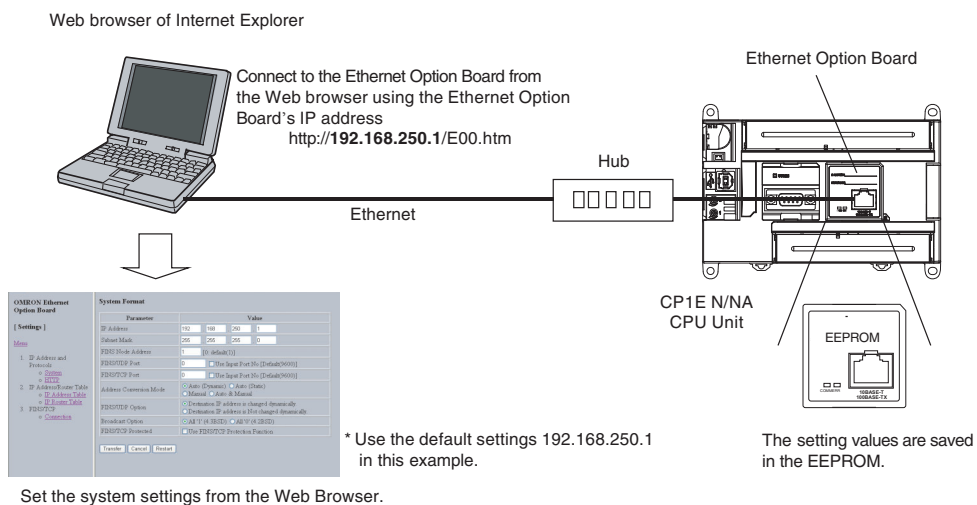

### Additional Information

If the Ethernet Option Board's IP address cannot be set by the Web browser function, it can be set in the IP address display/setting area (D1455 and D1456) in the allocated words in the DM area.

## 17-3-2 Transferring Data from the CPU Unit

The Ethernet Option Board can read data from the allocated words in the DM area and CIO area of the CPU Unit.

- DM area allocation:  
Display the initial settings of the Ethernet Option Board using the Web browser function.
- CIO area allocation:  
Store the status of the Ethernet Option Board.

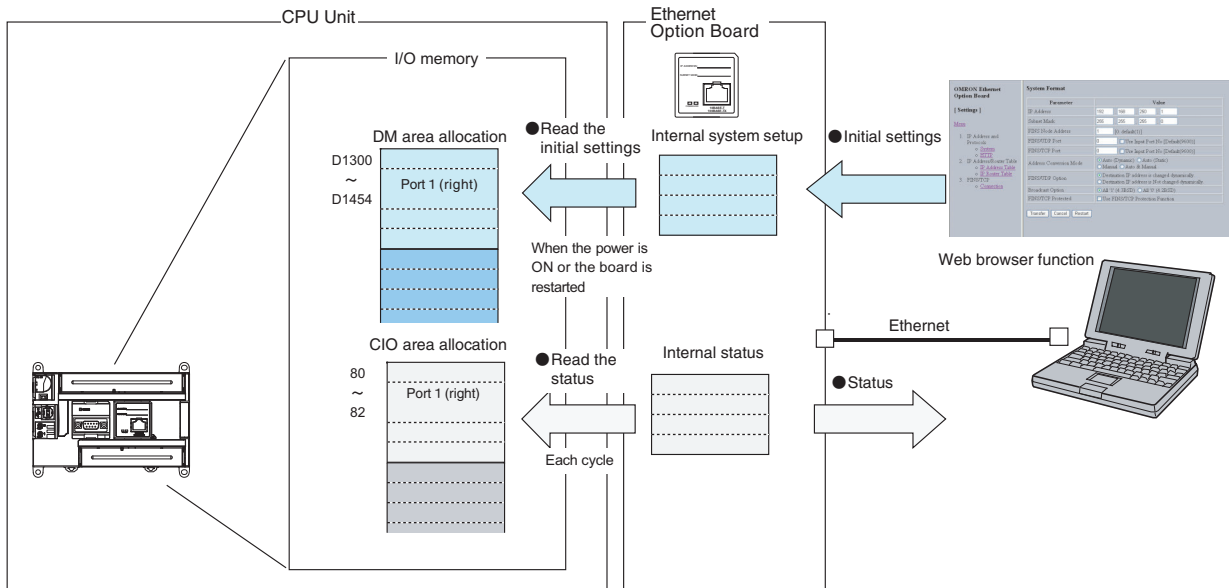

**Note** The initial settings of the Ethernet Option Board cannot be set in the allocated words in the DM area or in the CX-Programmer's system settings.

### Confirmation on the Settings of the Ethernet Option Board

The settings of the Ethernet Option Board can be confirmed by the following two methods.

- Web browser function: Confirm from the Web browser of a computer connected with Ethernet.
- Allocated words in the DM area (D1300 to D1356): The setting values will be read to the CPU Unit from the Ethernet Option Board when the power is ON. Confirm the PLC memory with the CX-Programmer.

### Confirmation on the Status of the Ethernet Option Board

The status of the Ethernet Option Board can be confirmed by the following two methods.

- Web browser function: Confirm from the Web browser of a computer connected with Ethernet.
- Allocated words in the CIO area (CIO 80 to CIO 82): The status is stored in the CPU Unit from the Ethernet Option Board every 3 to 5 seconds. It is used for the status confirmation in the ladder programmer.

### 17-3-3 Default Settings

The default settings of the Ethernet Option Board are shown in the following tables.

Make the initial settings by the Web browser function if the settings are not as follows.

- Common Settings of the FINS/UDP and FINS/TCP Methods

Item	Initial settings
IP Address	192.168.250.1
Subnet Mask	255.255.255.0
FINS Node Address	1
Baud Rate	Auto
IP Router Table	None (IP router not enabled)

- Using the FINS/UDP Method

Item	Initial settings
FINS/UDP Port	9,600
Address Conversion Mode	Auto (Dynamic)
IP Address Table	None
FINS/UDP Option	Destination IP address is changed dynamically
Broadcast Option	All '1' (4.3 BSD)

- Using the FINS/TCP Method

Item	Initial settings
FINS/TCP Port	9,600
FINS/TCP Connection Setup	None
FINS/TCP Protected	Use protection function according to IP address

The following diagram describes how to restore the initial settings of the Ethernet Option Board.

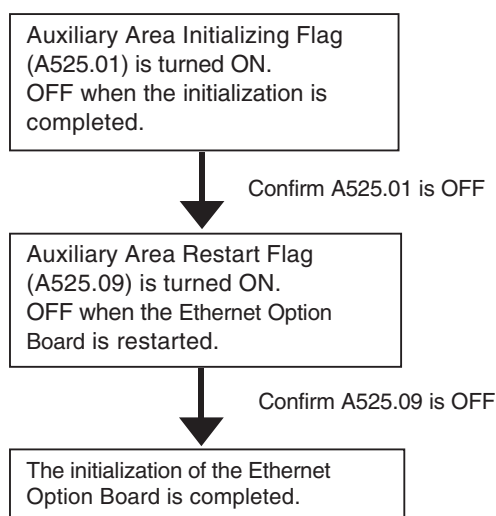

## FINS Node Address of the Ethernet Option Board

The FINS node address of the Ethernet Option Board is factory-set to 1.

Local FINS Node Address=1

It can be changed in the *Settings* from the Web browser. The setting range is 1 to 254.

## IP Address of the Ethernet Option Board

The IP address of the Ethernet Option Board (Local IP address) is factory-set to 192.168.250.1.

Local IP Address=192.168.250.1

Local IP address can be set by the following two methods.

Method 1: Set in the *Settings* from the Web browser

Method 2: Set to 0.0.0.0 from the Web browser, and then set in the allocated words in the DM area (D1455 and D1456) by the ladder programmer

If the local IP address is set neither by method 1 nor by method 2 (at default settings), it remains 192.168.250.1.

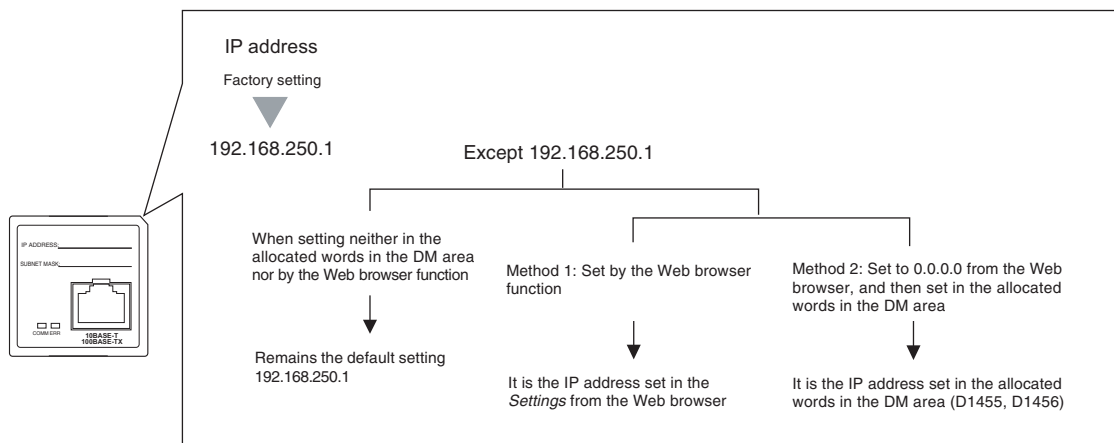

### ● Confirmation on Local IP Address

The local IP address can be confirmed in the allocated words in the DM area (D1455 and D1456), when the power of the PLC is turned OFF and then ON again.

## 17-3-4 Web Browser Setting Function

The Ethernet Option Board's Web window is displayed by accessing the URL from the Web browser.

The Web server supports the multi-language function. The supported language are English, Chinese and Japanese. Before setting, users should select the appropriate language in the following URL.

**English page:** [http://\(Ethernet Option Board's IP address\)/E00.htm](http://(Ethernet Option Board's IP address)/E00.htm)

**Chinese page:** [http://\(Ethernet Option Board's IP address\)/C00.htm](http://(Ethernet Option Board's IP address)/C00.htm)

**Japanese page:** [http://\(Ethernet Option Board's IP address\)/J00.htm](http://(Ethernet Option Board's IP address)/J00.htm)

In this example, use the following procedure to set the IP address using Internet Explorer version 6.0 and the Ethernet Option Board's English Web pages.

- 1** Connect the Ethernet Option Board to the computer  
Use cross cables when connecting directly, use straight cables when connecting with hubs.
- 2** Set computer's IP address by manual
  - (1) Select **Local Area Connection** in Windows' **Network Connection** Tab. Right-click and select **Properties** in the pop-up menu.
  - (2) Select **Internet Protocol (TCP/IP) - Properties**.
  - (3) Select **Use the following IP address**, and then set computer's IP address by manual.  
Set computer's IP address to 192.168.250.A.  
The setting range of the post number A is 2 to 254.  
For example, set to 192.168.250.2.
- 3** Connect to the Ethernet Option Board from the Web browser using the Ethernet Option Board's default IP address.  
**<http://192.168.250.1/E00.htm>**

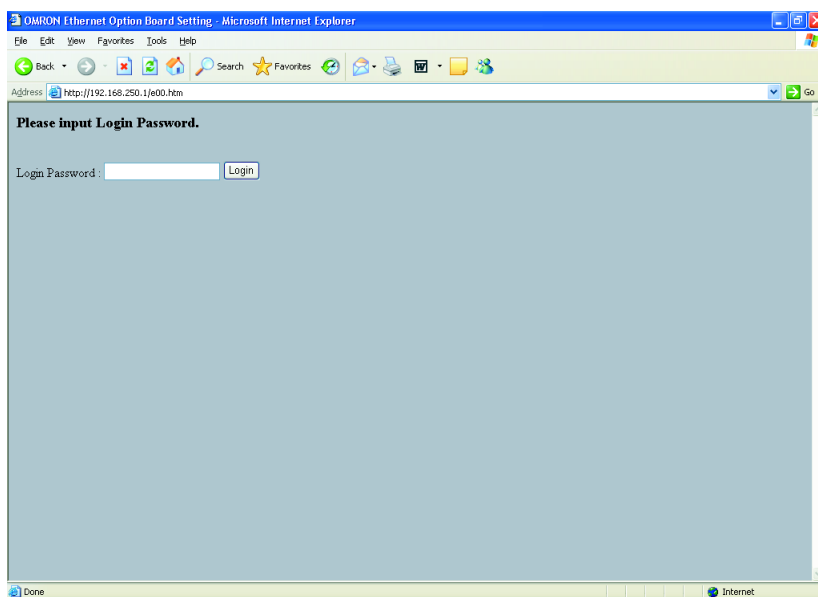

#### 4 Input the default password “ETHERNET” and click the **Login** Button.

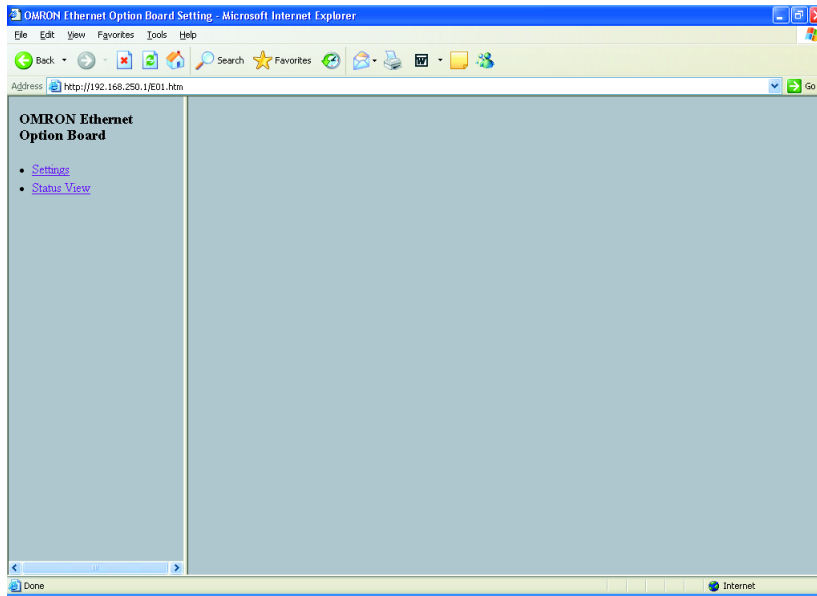

#### 5 Select **Settings** from the menu on the left side of the window to display the Settings Menu.

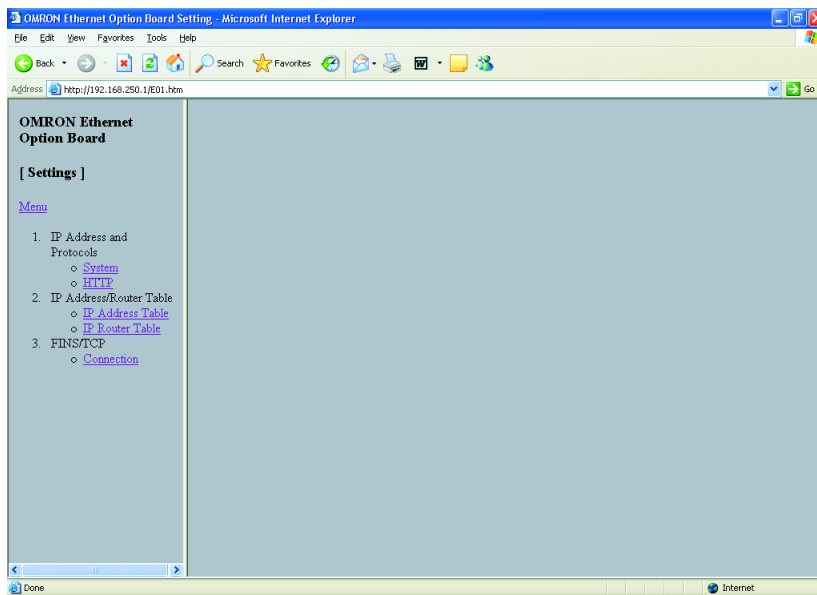

## 6 Select **1. IP address and Protocols - System** to display System menu.

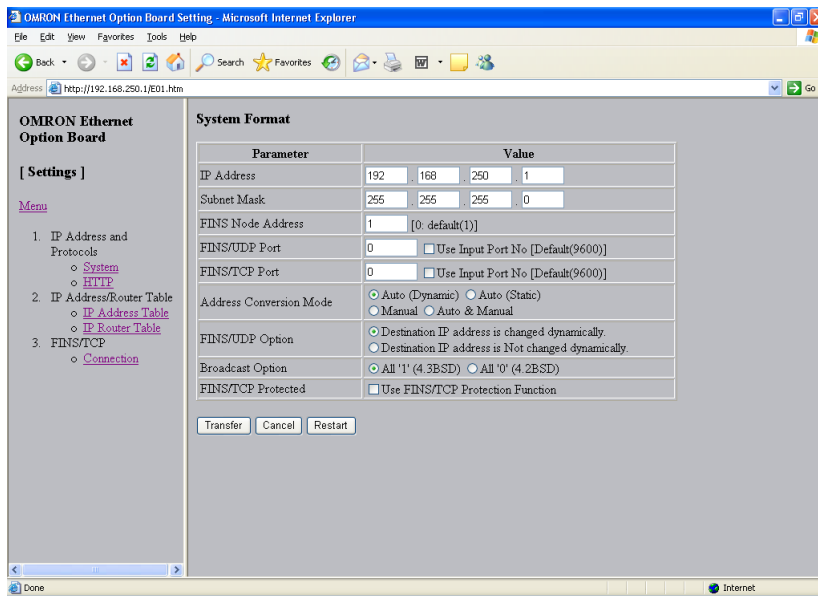

## 7 Make the required settings (i.e., the IP address in this example).

Parameter	Value
IP Address	192 . 168 . 250 . 1
Subnet Mask	255 . 255 . 255 . 0
FINS Node Address	1 [0: default(1)]
FINS/UDP Port	0 <input type="checkbox"/> Use Input Port No [Default(9600)]
FINS/TCP Port	0 <input type="checkbox"/> Use Input Port No [Default(9600)]

## 8 After entering the correct values, click the Transfer Button to transfer the settings to the Ethernet Option Board.

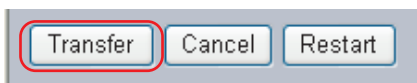

## 9 To enable the new settings, turn the power to the Ethernet Option Board OFF and ON again, or click the Restart Button.

The functions of the buttons are as follows.

Button	Function
Transfer	Transfer the entered values from the personal computer to the Ethernet Option Board. (The new settings are invalid until the Ethernet Option Board has been reset.)
Cancel	Cancel the entered values.
Restart	Restart the Ethernet Option Board to enable the new settings after transfer. The Restart button is invalid to the PLC.

System setup for the Ethernet Option Board is as follows.

## System Format

**OMRON Ethernet Option Board**

[ Settings ]

[Menu](#)

1. IP Address and Protocols
  - [System](#)
  - [HTTP](#)
2. IP Address/Router Table
  - [IP Address Table](#)
  - [IP Router Table](#)
3. FINS/TCP
  - [Connection](#)

**System Format**

Parameter	Value
IP Address	192 . 168 . 250 . 1
Subnet Mask	255 . 255 . 255 . 0
FINS Node Address	1 [0: default(1)]
FINS/UDP Port	0 <input type="checkbox"/> Use Input Port No [Default(9600)]
FINS/TCP Port	0 <input type="checkbox"/> Use Input Port No [Default(9600)]
Address Conversion Mode	<input checked="" type="radio"/> Auto (Dynamic) <input type="radio"/> Auto (Static) <input type="radio"/> Manual <input type="radio"/> Auto & Manual
FINS/UDP Option	<input checked="" type="radio"/> Destination IP address is changed dynamically. <input type="radio"/> Destination IP address is Not changed dynamically.
Broadcast Option	<input checked="" type="radio"/> All '1' (4.3BSD) <input type="radio"/> All '0' (4.2BSD)
FINS/TCP Protected	<input type="checkbox"/> Use FINS/TCP Protection Function

Item	Contents	Default
IP Address	Set the local IP address for the Ethernet Option Board. <ul style="list-style-type: none"> <li>Setting range: 00.00.00.00 to 223.255.255.255</li> </ul>	192.168.250.1
Subnet Mask	Set the subnet mask for the Ethernet Option Board. This is required if a method other than the IP address table method is used for address conversion.	255.255.255.0
FINS Node Address	Set the local FINS node address for the Ethernet Option Board. <ul style="list-style-type: none"> <li>Setting range: 1 to 254</li> </ul>	1
FINS/UDP Port	Specify the local UDP port number to be used for the FINS communications service. The UDP port number is the number used for UDP identification of the application layer (i.e., FINS communications service). <ul style="list-style-type: none"> <li>Setting range: 1 to 65,535</li> </ul>	9,600
FINS/TCP Port	Specify the local TCP port number to be used for the FINS communications service. The TCP port number is the number used for TCP identification of the application layer (i.e., the FINS communications service in this case). <ul style="list-style-type: none"> <li>Setting range: 1 to 65,535</li> <li>Make the settings so that the TCP port number 80 for HTTP does not overlap.</li> </ul>	9,600
Use Input Port No.	Check this checkbox, if you want the user defined port number for UDP or TCP to be in effect.	Unchecked
Address Conversion Mode	Select any of the following as the method for finding and converting IP addresses from FINS node addresses. (Enabled for FINS/UDP only.) <ul style="list-style-type: none"> <li>Auto (dynamic): Automatic generation (dynamic)</li> <li>Auto (static): Automatic generation (static)</li> <li>Manual: IP address table method</li> <li>Auto &amp; Manual: Combined method</li> </ul>	Auto (dynamic)
FINS/UDP Option	Select to dynamically change the remote (destination) IP address for FINS/UDP or not. To prohibit dynamic changes, check the second box.	Change dynamically



Item	Contents	Default
Broadcast Option	Set the method for specifying IP addresses for broadcasting in FINS/UDP. <ul style="list-style-type: none"> <li>All '1' (4.3BSD): Broadcast with host number set to all ones.</li> <li>All '0' (4.2BSD): Broadcast with host number set to all zeros.</li> </ul> Normally the default setting should be used.	All '1' (4.3BSD)
FINS/TCP Protected	When this option is selected, if the FINS/TCP connection is set to a server, and if an IP address other than 0.0.0.0 is set to destination IP address, any connection request from other than the setting IP address will be denied.  Select this option to prevent faulty operation (by FINS commands) from specific nodes from affecting the PLC.	Unchecked

## HTTP Server Setup

**OMRON Ethernet Option Board**

[ Settings ]

[Menu](#)

1. IP Address and Protocols
  - [System](#)
  - [HTTP](#)
2. IP Address/Router Table
  - [IP Address Table](#)
  - [IP Router Table](#)
3. FINS/TCP
  - [Connection](#)

**HTTP Server Setup**

Parameter	Value
WEB Password	<input style="width: 90%;" type="text"/>
Port Number	<input style="width: 40%;" type="text" value="0"/> [0: default(80)]

Item	Contents	Default
WEB Password	Set the password for accessing the Ethernet Option Board's settings and status monitoring information.	ETHERNET
Port Number	Set the port No. used to connect to the Web browser.	80

## IP Address Table

Set the IP address table that defines the relationship between FINS node addresses and IP addresses. With FINS/UDP, this is enabled only when the IP address table method is set to the IP address conversion method.

Item	Contents	Default
FINS Node Address	Set the node address for the remote device.	None
IP Address	Set the related IP address for the remote device.	None

## IP Router Table

Set the IP router table when the Ethernet Option Board is to communicate through the IP router with nodes on another IP network segment.

Item	Contents	Default
IP Network Address	Set the network ID from the IP address.	None
Router IP Address	Set the related IP address of a router connected to a network.	None

## FINS/TCP Connection Setup

OMRON Ethernet Option Board

[ Settings ]

[Menu](#)

1. IP Address and Protocols
  - o [System](#)
  - o [HTTP](#)
2. IP Address/Router Table
  - o [IP Address Table](#)
  - o [IP Router Table](#)
3. FINS/TCP
  - o [Connection](#)

**FINS/TCP Connection Setup**

No	Mode	Value
1	FINS/TCP Server	IP Address : 0 . 0 . 0 . 0 Auto-allocated FINS Node : 251
2	FINS/TCP Server	IP Address : 0 . 0 . 0 . 0 Auto-allocated FINS Node : 252

Item	Contents	Default
No.	Shows the connection number. This is a network API used when TCP is used for the FINS communications service. Up to 2 can be used at a time, and they are identified by connection numbers 1 to 2. The Ethernet Option Board can thus simultaneously execute the FINS communications service by TCP with up to 2 remote nodes.	---
IP Address	If the option is selected to use IP addresses to protect, set the IP addresses as required at clients from which connection is permitted. If not set for those connections, the default setting can be used.	0.0.0.0
Auto-allocated FINS node	If the client (normally a personal computer) application supports FINS/TCP, and if FINS node addresses are not fixed, the client will take 0 as its node address. Then, when a FINS command arrives, the number set here (from 251 to 252) will automatically be allocated as the client's FINS node address.	From 251 to 252, for connection No. 1 to 2

## Unit Information

Parameter	Value
Model	CP1W-CIF41
Version	V1.05
IP Address	192.168.250.1
Subnet Mask	255.255.255.0
FINS/UDP Port Number	9600
Use Input Port Number	Unused
Broadcast Setting	All '1' (4.3BSD)
IP Address Conversion	Auto (Dynamic)
Ethernet Address	00-00-0A-3A-C0-05

Parameter	Contents
Model	Show the model information of the Ethernet Option Board.
Version	Show the version information of the Ethernet Option Board.
IP Address	Show the IP address of the Ethernet Option Board.
Subnet Mask	Show the subnet mask of the Ethernet Option Board.
FINS/UDP Port Number	Show the FINS/UDP port number of the Ethernet Option Board.
Use Input Port Number	Show the effective port number setting mode.
Broadcast Setting	Show the broadcast setting of the Ethernet Option Board.
IP Address Conversion	Show the IP address conversion method of the Ethernet Option Board.
Ethernet Address	Show the MAC ID of the Ethernet Option Board.

## Unit Status

OMRON Ethernet Option Board		Unit Status	
[ Status View ]			
<a href="#">Menu</a>			
<ol style="list-style-type: none"> <li>1. <a href="#">Unit Information</a></li> <li>2. <a href="#">Unit Status</a></li> <li>3. <a href="#">FINS Status</a></li> <li>4. <a href="#">Error Log</a></li> </ol>			
		Parameter	Value
Error Flags		IP Address Error	Normal
		IP Address Table Error	Normal
		IP Router Table Error	Normal
		Router Table Error	Normal
		Address Disagreement	Normal
		EEPROM Error	Normal
Total Number of Packets Received			0
Total Number of Receive Errors			0
Total Number of Packets Sent			0
Total Number of Errors Sent			0

Parameter	Contents
Error Flags	Indicate the operating status and errors that occurred when the Ethernet Option Board is turned ON.
Total Number of Packets Received	Show the total number of packets received by the Ethernet Option Board.
Total Number of Receive Errors	Show the total number of errors detected while the Ethernet Option Board was receiving. The types of errors detected are short packet errors, alignment errors, CRC errors, frame length errors and communication controller overflow errors.
Total Number of Packets Sent	Show the total number of packets sent by the Ethernet Option Board.
Total Number of Errors Sent	Show the total number of errors detected while the Ethernet Option Board was sending.

## FINS Status

Parameter	Contents
Node	Show the FINS node address.
Connection Type	Show the protocol used by connection with the related node address.
Local Port No.	Show the port number of the Ethernet Option Board for connection with the related node address.
Remote IP	Show the IP address of the related node address.
Remote Port No.	Show the remote port number of the related node address for connection.
TCP Connection No.	If the connection is the FINS/TCP, show the connection number (1 to 4).
TCP Status	If the connection is the FINS/TCP, show the current connection status.

The details of TCP status are listed as the following table.

Status	Meaning
CLOSED	Connection closed
LISTEN	Waiting for connection
SYN SENT	SYN sent in active status
SYN RECEIVED	SYN received and sent
ESTABLISHED	Already established
CLOSE WAIT	FIN received and waiting for completion
FIN WAIT1	Completed and FIN sent
CLOSING	Completed and exchanged FIN. Awaiting ACK.
LAST ACK	FIN sent and completed. Awaiting ACK.
FIN WAIT2	Completed and ACK received. Awaiting FIN.
TIME WAIT	After closing, pauses twice the maximum segment life (2MSL).

The function of the button is as follows.

Button	Function
Send	Show the FINS status of the selected No.

## Error Log

OMRON Ethernet Option Board

[ Status View ]

[Menu](#)

1. [Unit Information](#)
2. [Unit Status](#)
3. [FINS Status](#)
4. [Error Log](#)

**Error Log**

No.	Error Code	Detail Code	Date
01			

Send Clear Error Log

Parameter	Contents
No.	Show the error recorder number.
Error Code	Show the error code of the error recorder.
Detail Code	Show the detail error code of the error recorder.
Date	Show the date of the error recorder.

The functions of the buttons are as follows.

Button	Function
Send	Show the error log of the selected No.
Clear Error Log	Clear the error log table.

## 17-4 Memory Allocations

### 17-4-1 DM Area Allocation

The memory allocation about system setup is shown as the following diagram. These data will be allocated to the DM area of PLC. The range of the DM area is D1300 to D1456.

Offset	D15	D0
D1300	Mode setting (1 word)	
D1301	FINS/TCP port number (1 word)	
D1302	FINS/UDP port number (1 word)	
D1303 D1304	IP address (2 words)	
D1305 D1306	Subnet mask (2 words)	
D1307	Reserved (1 word)	
D1308 to D1404	IP address table (97 words)	
D1405 to D1437	IP router table (33 words)	
D1438 to D1448	FINS/TCP connection setup (11 words)	
D1449 to D1453	HTTP server setup (5 words)	
D1454	FINS node address (1 word)	
D1455 D1456	Using IP Address Display/Setting Area (2 words)	

- Note 1** D1300 to D1454 can only display all of the settings stored in the unit. Modification in this area is invalid to the CP1W-CIF41 Ethernet Option Board.
- 2** D1455 and D1456 will display the IP address used by the CP1W-CIF41 when the power is turned ON.
- 3** When the IP address is illegal, such as using CLASS D, CLASS E IP address, the values in D1303 and D1304 will be different from the ones in D1455 and D1456, and the CP1W-CIF41 will temporarily use the default IP address (192.168.250.1). Use this IP address to modify the IP address settings through Web browser.
- 4** When the system settings are wrong, A525 can be used to reset CP1W-CIF41. Refer to *Appendix A-2* for details.



## Mode Setting

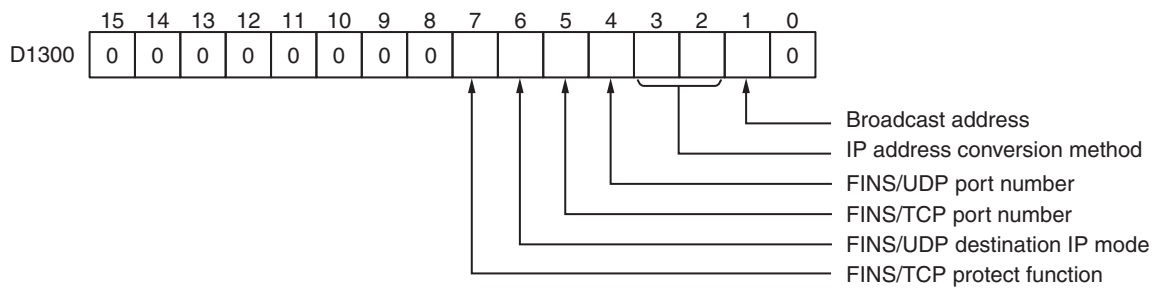

Bit	Mode	Settings
0	Reserved	Always 0.
1	Broadcast address	0: 4.3BSD specifications 1: 4.2BSD specifications
2 to 3	IP address conversion method	00, 01: Automatic generation method 10: IP address table reference method 11: Combined method
4	FINS/UDP port number	0: Default (9600) 1: Unit setup value
5	FINS/TCP port number	0: Default (9600) 1: Unit setup value
6	FINS/UDP destination IP mode	0: Enable (Dynamically) 1: Disable (Static)
7	FINS/TCP protect function	0: Disable (Only FINS/TCP Server) 1: Enable (Only FINS/TCP Server)
8 to 15	Reserved	Always 0.

## FINS/TCP and FINS/UDP Port Number

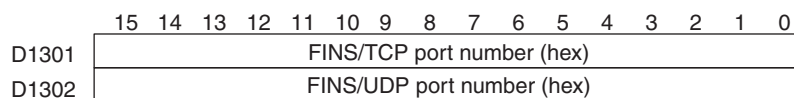

When displaying 0000, the port number is 9600.

## IP Address

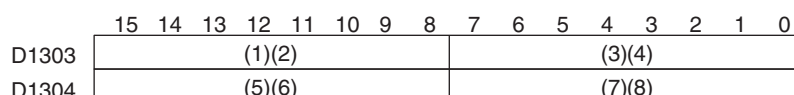

The IP address is (1)(2).(3)(4).(5)(6).(7)(8) (hex)

## Subnet Mask

	15	14	13	12	11	10	9	8	7	6	5	4	3	2	1	0
D1305	(1)(2)								(3)(4)							
D1306	(5)(6)								(7)(8)							

The Subnet mask is (1)(2).(3)(4).(5)(6).(7)(8) (hex)

## IP Address Table

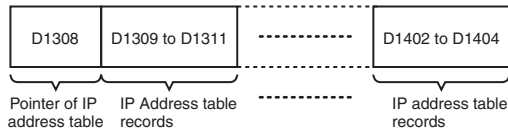

### ● Pointer of IP Address Table

Point to the last recorder in IP address table. For example, if the last recorder number in IP address table is 6, the value of this word is 6.

### ● IP Address Table Records

Each IP address table record has 6 bytes. The max number of records is 32. The configuration of the 6 bytes of data in each record is as shown in the following diagram.

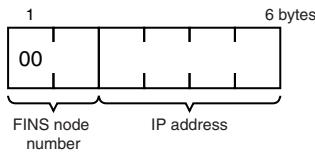

## IP Router Table

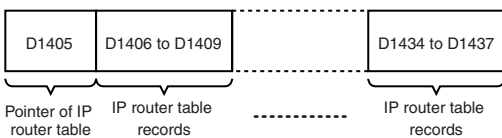

### ● Pointer of IP Router Table

Point to the last recorder in IP router table. For example, if the last recorder number in IP router table is 6, the value of this word is 6.

### ● IP Router Table Records

Each IP router table record has 8 bytes. The max number of records is 8. The configuration of the 8 bytes of data in each record is as shown in the following diagram.

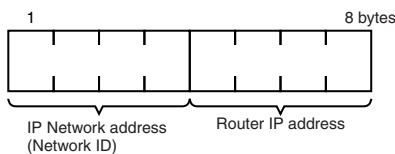

## FINS/TCP Connection Setup

Offset	15	8	7	0
D1438	FINS/TCP Port Settings			
D1439	FINS/TCP connection No.1		FINS/TCP connection No.1	
D1440	FINS/TCP connection No.1		FINS/TCP connection No.1	
D1441	FINS/TCP connection No.1		FINS/TCP connection No.2	
D1442	FINS/TCP connection No.2		FINS/TCP connection No.2	
D1443	FINS/TCP connection No.2		FINS/TCP connection No.2	
D1444	Reserved (Always 0)			
⋮				
D1448				

### ● FINS/TCP Port Settings

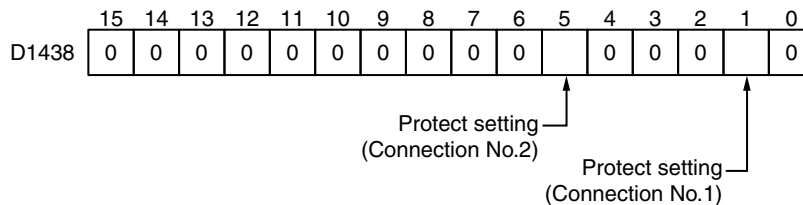

Bit	Settings	Unit operation
0	Reserved	Always 0.
1	Protect setting	0: The IP address of FINS/TCP connection No.1 is not under the protection. 1: The IP address of FINS/TCP connection No.1 is under the protection.
2 to 4	Reserved	Always 0.
5	Protect setting	0: The IP address of FINS/TCP connection No.2 is not under the protection. 1: The IP address of FINS/TCP connection No.2 is under the protection.
6 to 15	Reserved	Always 0.

### ● FINS/TCP Connection No.1 to 2

Each FINS/TCP connection number has 5 bytes. The configuration of the 5 bytes of data in each number is as shown in the following diagram.

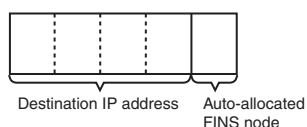

## HTTP Server Setup

Offset	15	8	7	0
D1449	HTTP Password			
⋮				
D1452	HTTP Port number			
D1453				

If the password for accessing the Ethernet Option Board's Web page is forgotten, find out it in this area. It is written in ASCII format.

## FINS Node Address

	15	14	13	12	11	10	9	8	7	6	5	4	3	2	1	0
D1454	FINS node address (hex)															

The setting range is 0~ FE (hex).

## Using IP Address Display/Setting Area

	15	14	13	12	11	10	9	8	7	6	5	4	3	2	1	0
D1455	(1)(2)								(3)(4)							
D1456	(5)(6)								(7)(8)							

The IP address is (1)(2).(3)(4).(5)(6).(7)(8) (hex)

If the local IP address in the system setup is set to a value other than 0.0.0.0, this area will act as an IP address display area and the local IP address in the system setup will be read and stored here when the power is turned ON or the Ethernet Option Board restarted.

If the local IP address in the system setup is set to 0.0.0.0, this area will act as an IP address setting area. The value will be read by the Ethernet Option Board when the power is turned ON or the Ethernet Option Board restarted and is used as the local IP address.

If the IP address for accessing the Ethernet Option Board through Web browser is forgotten, find out it in this area.

**Note** When IP address in system setup area and DM area are all set to 0.0.0.0, the IP address will be 192.168.250.1 (FINS node address).

## 17-4-2 CIO Area Allocation

The memory allocation about communication services status in the CIO area of PLC is shown as the following diagram. The range of the CIO area is CIO80 to CIO82.

Offset	D15	D0
CIO 80	Service Status	
CIO 81	Error Status	
CIO 82	FINS/TCP Connection Status	

### Service Status

	15	14	13	12	11	10	9	8	7	6	5	4	3	2	1	0
CIO 80	1		0	0	0	0	0	0	0	0	0	0	0	0	0	0

Bit	Name	Unit operation
0 to 13	Reserved	Always 0.
14	Link Status	0: The link between hubs is terminated. 1: A link is established between hubs.
15	Reserved	Always 1.



#### Precautions for Correct Use

Bit 15 is used for detect power condition of PLC, so do not change it at any time. Otherwise the CP1W-CIF41 Ethernet Option Board will generate error.

## Error Status

The status of errors that occur at the Ethernet Option Board is reflected as shown in the following diagram.

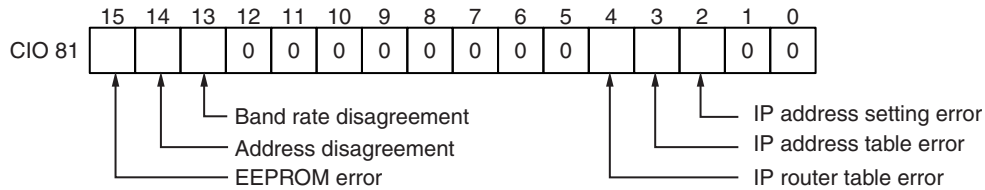

Bit	Name	Correction
0 to 1	Reserved	Always 0.
2	IP address setting error	The following cannot be used as IP address settings. <ul style="list-style-type: none"> <li>• Host IDs that are all 0 or all 1.</li> <li>• Network IDs that are all 0 or all 1.</li> <li>• Subnetwork IDs that are all 1.</li> <li>• Addresses beginning with 127 (7F hex).</li> </ul> Reset the IP address.
3	IP address table error	Correct the IP address table. If the problem cannot be resolved, replace the CPU Unit.
4	IP router table error	Correct the IP router table. If the problem cannot be resolved, replace the CPU Unit.
5 to 6	Reserved	Always 0.
7 to 12	Reserved	Always 0.
13	Baud rate disagreement	Make sure that the baud rate setting of the Serial Option Port is 115,200 bps. Change the baud rate of the Serial Option Port.
14	Address disagreement	Make sure that the node number and the last byte of the IP address are the same and then set other host IDs to 0. Change the address conversion method.
15	EEPROM error	Restart the PC. If the problem cannot be resolved, replace the Ethernet Option Board.

## FINS/TCP Connection Status

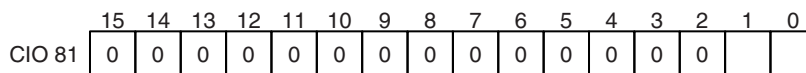

Bit	Switch	Unit operation
0	FINS/TCP Connection No.1	0: The connection is terminated. 1: A connection is established.
1	FINS/TCP Connection No.2	0: The connection is terminated. 1: A connection is established.
2 to 15	Reserved	Always 0.

# 17-5 Troubleshooting

## 17-5-1 Error Log

The Ethernet Option Board provides an error log that records errors occurred during Ethernet Option Board operation. The contents of the error log can be read or cleared from the Web Browser.

### Logged Errors

The following errors are recorded in the error log.

- Errors in network operation
- Errors in data transfers
- Error in the CPU unit

### Error Log Table

Each error is recorded as one record in an error log table. Up to 20 records can be saved. If more than 20 errors occur, the oldest errors will be deleted from the error log and the most recent error will be recorded.

The following information is recorded in the error log table.

- Main error code (see table later in this section)
- Detailed error code (see table later in this section)
- Time stamp (from the clock in the CPU unit)

**Note** During the initialization of the Ethernet Option Board, if an error occurs, the error log time stamp will record as 2000-00-00 00:00:00.

### Error Log Location

When an error is detected, the error codes and time stamp are recorded in the error log in RAM inside the Ethernet Option Board. Serious errors are also recorded in EEPROM. The maximum number of errors that can be saved to EEPROM is 20 for the CP1L and CP1H. The errors recorded in EEPROM will be saved even if the unit is restarted or power is turned OFF.

## 17-5-2 Error Codes

The error codes and ERR LED are described in the following table. The detailed error code will provide detailed information on an error.

Error code	ERR LED	Meaning	Detailed error code		Correction	EEPROM
			1st byte	2nd byte		
0002	LIT	CPU Unit service monitoring error	Monitor time (ms)		Set the PLC Settings on the Serial Option Port Tab as follows, and then turn the power ON again. Communications Settings <ul style="list-style-type: none"> <li>• Baud: 115200</li> <li>• Format: 7, 2, E</li> <li>• Mode: Host Link</li> </ul>	Saved
0015	FLASH	CPU Unit fatal error			Eliminate the cause of the error in the CPU Unit.	---
0110	---	Too many relay points (send failed)	Commands Bit 15: OFF Bits 08 to 14: SNA Bits 00 to 07: SA1		Reconstruct the network or correct the routing tables so that commands are sent to within a 3-level network range.	---
0111	---	Command too long (send failed)	Responses Bit 15: ON		Check the command format and set the correct command data.	---
0112	---	Header error (send failed)	Bits 08 to 14: DNA Bits 00 to 07: DA1		Check the command format and set the correct command data.	---
0117	---	Internal buffers full; packet discarded			Change the network so that traffic is not concentrated.	---
0123	---	Internal send buffers full; packet discarded			Change the network so that traffic is not concentrated.	---
0125	---	Time out error			Resend the command.	---
021A	FLASH	Logic error in setting table	00	04: Unit Setup	Recreate the data specified by the 2nd byte of the detailed error code.	Saved
03C0	FLASH	FINS/TCP setting error	01 to 02: Connection No.	01: Automatically allocated FINS node address duplication 02: Destination IP address error 03: Destination port number error	Set the FINS/TCP settings correctly.	---
03C2	---	FINS/TCP packet discarded	01 to 02: Connection No.	03: Reception error	Resend the command.	---
				04: Transmission error	There is too much load (traffic) on the Ethernet Option Board. Correct the system so that traffic is not concentrated.	



Error code	ERR LED	Meaning	Detailed error code		Correction	EEPROM
			1st byte	2nd byte		
03C3	---	FINS/UDP Packet discarded	00	01 to FE Node address	The automatic generation (static) method was used as the IP address conversion method, so remote IP address information in internal memory could not be changed.	---
03C8	---	Socket Error	Arbitrary		Resend the packet or the destination node is not in the network.	---
03D0	FLASH	System setup sum value error			Reset the value of system setup area, Restart CPU Unit.	Saved
0601	LIT	Option Board error	Arbitrary		Restart the CPU Unit. If the problem persists, replace the Ethernet Option Board.	Saved
0602	LIT	Option Board memory error	01: Read error 02: Write error	06: Error log	Restart the CPU Unit. If the problem persists, replace the Ethernet Option Board.	Saved (except error log)
---	FLASH	Serial Option Port Communications Settings error			Set the PLC Settings on the Serial Option Port Tab as follows, and then turn the power ON again. Communications Settings <ul style="list-style-type: none"> <li>• Baud: 115200</li> <li>• Format: 7, 2, E</li> <li>• Mode: Host Link</li> </ul>	---

### 17-5-3 Error Status

The Ethernet Option Board will output error status to the following word in CIO 80 of the CPU Unit. This information can be used in troubleshooting errors.

Bit	Error	Correction
02	IP address setting error	The following cannot be used as the IP address of the Ethernet Option Board. <ul style="list-style-type: none"> <li>All bits in the host ID are 0 or 1.</li> <li>All bits in the network ID are 0 or 1.</li> <li>All bits in the subnet ID are 1.</li> <li>The IP address begins with 127 (0x7F).</li> </ul> Reset the IP address.
03	IP address table error	The IP address table information is incorrect. Reset the IP address table. If the problem cannot be resolved, replace the CPU Unit.
04	IP router table error	The IP router table information is incorrect. Reset the IP router table. If the problem cannot be resolved, replace the CPU Unit.
13	Baud rate disagreement	Set the PLC Settings on the Serial Option Port Tab as follows, and then turn the power ON again. <ul style="list-style-type: none"> <li>Baud: 115200</li> <li>Format: 7,2,E</li> <li>Mode: Host Link</li> <li>Unit Number: 0</li> </ul> Except the settings mentioned above, ERR LED will be lit without error codes.
14	Address disagreement	The local IP address host number and FINS node address do not agree. Confirm whether they agree or not. The local IP address of the Ethernet Option Board is 192.168.250.1. The default FINS node address of the Ethernet Option Board is 1. Change the settings either in the allocated words in the DM area or by the Web browser function to make the local IP address host number and FINS node address be the same. In addition, Change the Address Conversion Mode to "Manual" or "Auto & Manual".
15	EEPROM error	Turn the power of the CPU Unit OFF and ON again to restart the Ethernet Option Board.



#### Precautions for Correct Use

When the values set by the Web browser function are wrong, the local IP address in valid at that time will be saved, not the values set in the words D1455 and D1456. Confirm the data of D1303 and D1304 in the PLC memory for the settings from the Web browser, after connecting the CX-Programmer online by USB.

## 17-6 Connection Method with the CX-Programmer

The CX-Programmer version 9.12 or higher can be connected online to the Ethernet Option Board with Ethernet. The connection method shows below.

In the following example, the Ethernet Option Board is connected without making any setting.

### Example

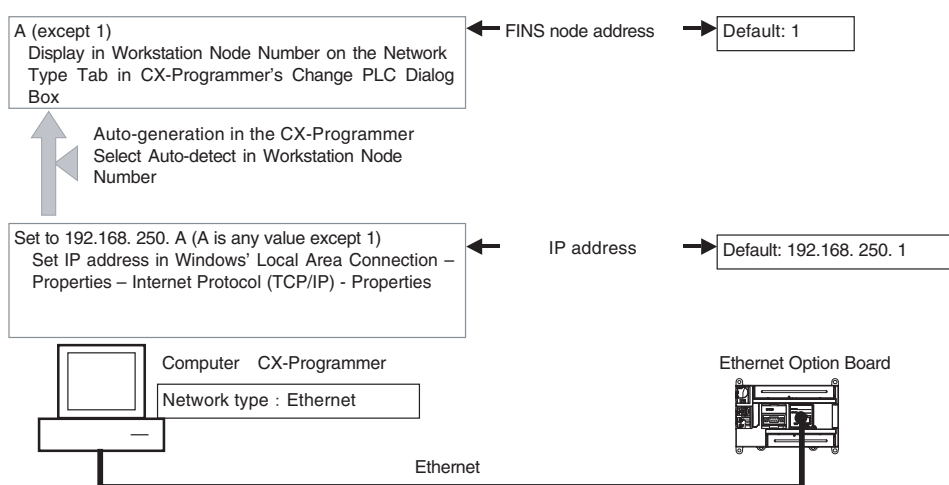

	Computer	Ethernet Option Board
IP address	192.168. 250.A (Set by manual on Windows)	192.168. 250.1 (Default)
Decision direction	↓	↑
FINS node address	A (Auto-generation in the CX-Programmer)	1 (Default)



#### Precautions for Correct Use

Confirm the Communications Settings on the Serial Option Port Tab in the PLC Settings Dialog Box of the CP1E CPU Unit. If the mode is set to Host Link and the baud rate to 9,600 or other values except 115,200, the CP1E CPU Unit cannot be connected with Ethernet. ERR LED of the Ethernet Option Board will be lit. Change the PLC Settings by USB port.

## Procedure

- 1** Connect the Ethernet Option Board to the computer  
Use cross cables when connecting directly, use straight cables when connecting with hubs.
- 2** Set computer's IP address by manual
  - (1) Select **Local Area Connection** in Windows' **Network Connection** Tab. Right-click and select **Properties** in the pop-up menu.
  - (2) Select **Internet Protocol (TCP/IP) - Properties**.
  - (3) Select **Use the following IP address**, and then set computer's IP address by manual.  
Set computer's IP address to 192.168.250.A.  
The setting range of the post number A is 2 to 254.  
For example, set to 192.168.250.2.
- 3** Register the target PLC using the CX-Programmer
  - (1) CX-Programmer's Change PLC Dialog Box
    - (a) Set **Device Name** to the target PLC, **PLC0** for example.
    - (b) Select **Ethernet** in **Network Type**.
    - (c) Click the **Settings** Button on the right side of **Network Type**.
  - (2) Network Settings [Ethernet] Dialog Box
    - (a) The settings in the **Network** Tab are as follows.
      - Set the network address to **0** (default) and the node address to **1** in **FINS Destination Address** settings.
      - Set **Frame Length** to **540** bytes max.
      - Set **Response Timeout(s)** to **5**.
    - (b) The settings in the **Driver** Tab are as follows.

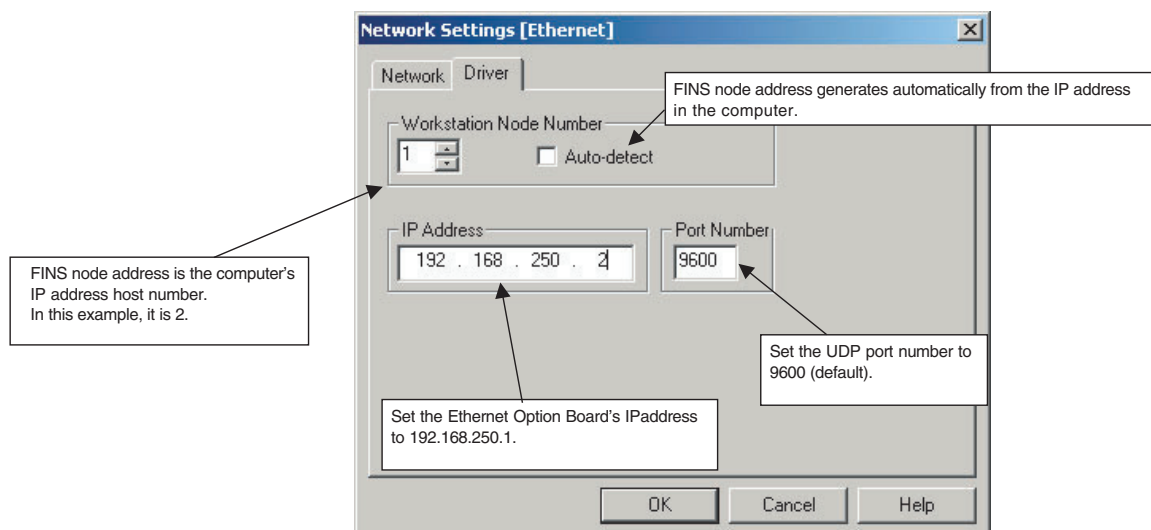

- The default setting for **Address Conversion Mode** of the Ethernet Option Board is **Auto (Dynamic)**, so select **Auto-detect** in the field of **Workstation Node Number**. Therefore, according to computer's IP address, computer's FINS node address is set automatically in the CX-Programmer. At that time, IP address port number and FINS node address are the same.  
In this example, **2** is displayed according to the host number of computer's IP address 192.168.250.2 set by manual, and it is invalid to change the setting.
- Set **IP address** to **192.168.250.1**, which is the Ethernet Option Board's IP address.
- Set **FINS/UDP Port** to **9600** (default), which is the UDP port number in the FINS communications service.

#### **4** Connect the target PLC online

Select **Work Online** in the **PLC** menu.

## 17-7 Network Installation

### 17-7-1 Devices Required for Constructing a Network

The basic configuration for a 100Base-TX Ethernet System consists of one hub to which nodes are attached in star form using twisted-pair cable. The devices shown in the following table are required to configure a network with 100Base-TX-type CP1W-CIF41, so prepared them in advance.

Network device	Contents
1. Ethernet Option Board (CP1W-CIF41)	The Ethernet Option Board is a Communication Unit that connects a CP1E N/NA-type CPU Unit to 100Base-TX Ethernet networks. (They can also be used as 10Base-T.)
2. Twisted-pair cable	This is twisted-pair cable for connecting 100Base-TX type Ethernet Option Board to the hub, with an RJ45 Modular Connector at each end. Use a category 3, 4, 5, or 5e UTP (unshielded twisted pair) or STP (shielded twisted-pair) cable.
3. Hub	This is a relay device for connecting multiple nodes in a star LAN.

### 17-7-2 Network Installation

#### Basic Installation Precautions

- Take the greatest care when installing the Ethernet System, being sure to follow ISO 802-3 specifications. You must obtain a copy of these specifications and be sure you understand them before attempting to install an Ethernet System. Unless you are already experienced in installing communications systems, we strongly recommend that you employ a professional to install your system.
- Do not install Ethernet equipment near sources of noise. If noise-prone environments are unavoidable, be sure to take adequate measures against noise interference, such as installing network components in grounded metal cases, using optical links in the system, etc.

#### Precautions on Laying Twisted-pair Cable

##### ● Basic Precautions

- Press the cable connector in firmly until it locks into place at both the hub and the Ethernet Option Board.
- After laying the twisted-pair cable, check the connection with a 10Base-T cable tester.

##### ● Environment Precautions

- The UTP cable is not shielded, and the hub is designed for use in OA environments. In environments subject to noise, construct a system with shielded twisted-pair (STP) cable and hubs suitable for an FA environment.
- Do not lay the twisted-pair cable together with high-voltage lines.
- Do not lay the twisted-pair cable near devices that generate noise.
- Do not lay the twisted-pair cable in locations subject to high temperature or high humidity.
- Do not lay the twisted-pair cable in locations subject to excessive dirt and dust or to oil mist or other contaminants.

## Precaution on Hub Installation

### ● Environment Precautions

- Do not install the hub near devices that generate noise.
- Do not install the hub in locations subject to high temperature or high humidity.
- Do not install the hub in locations subject to excessive dirt and dust or to oil mist or other contaminants.

## Hub Connection Methods

If more hub ports are required, they can be added by connecting more than one hub. There are two possible connection methods for hubs: Cascade and stacked.

### ● Cascade Connections

- Connect two hubs to each other as follows:
  - Connect an MDI port to an MDI-X port with a straight cable;
  - Connect two MDI ports with a cross cable;
  - Connect two MDI-X ports with a cross cable.

**Note** It is very difficult to distinguish cross cables and straight cables by appearance. Incorrect cables will cause communications to fail. We recommend using cascade connections with straight cables whenever possible.

- With cascade connections, up to 5 segments can be connected using up to 4 repeaters (i.e., 4 hubs).

### ● Stack Connections

- Connect the hubs using special cables or special racks.
- Normally there is no limit to the number of hubs in a stack, and each stack is treated as one hub. Some hubs, however, are limited in the number of hubs per stack.

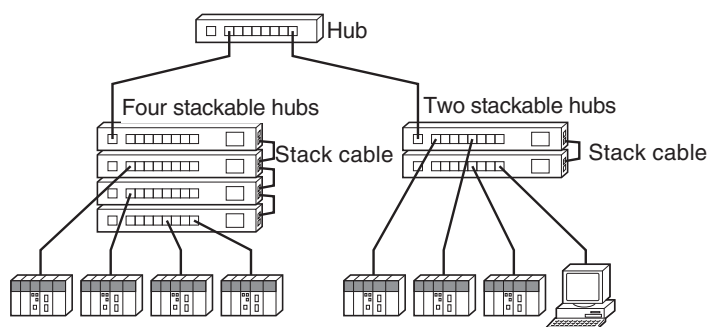

## 17-8 Comparison with Previous Models

Item		Previous Models	New Models
Model number		CS1W-ETN21 CJ1W-ETN21	CP1W-CIF41
Physical layer		100/10Base-TX	100/10Base-TX (Auto-MDIX)
Number of nodes		254	254
PLC maintenance via the Internet		Can send commands, including FINS commands, by e-mail over the Internet from a computer to the PLC.	Not supported
Server specification		Specification by IP address or by host name	Not supported
FINS communications service	Prerequisite to routing tables	<ul style="list-style-type: none"> <li>When multiple communications Units are mounted on the network</li> <li>When routing tables are used for other PLCs on the same network</li> </ul>	Not Supported (For the CP1L/CP1H CPU Units, when sending or receiving FINS commands from other nodes on the same Ethernet network by executing SEND, RECV or CMND instructions)
	Automatic IP address acquisition	A computer automatically acquiring IP addresses can send commands to the PLC and receive responses.	Same as previous models
	FINS communication with computer without fixed node address	Possible, with Automatic allocation by Ethernet Option Board (Client FINS automatic node address allocation function, TCP/IP only)	Same as previous models
	Handling TCP/IP	With FINS communications, both UDP/IP and TCP/IP (with up to 16 simultaneous connections and all can be set to client) possible.	With FINS communications, both UDP/IP and TCP/IP (with up to 2 simultaneous connections) possible.
	Simultaneous connection of multiple applications in a computer	Possible (with both UDP/IP and TCP/IP)	Same as previous models
Mail functions		Supported	Not Supported
FTP server function		Supported	Not Supported
Socket services function		Supported	Not Supported
Automatic clock information adjustment		Supported	Not Supported
FINS frame length		2,012	552 (CP1E) 1,016 (CP1L/CP1H)
Buffer numbers		392K bytes	8K bytes
Inner bus		Parallel	Serial port

**Note** Limited by the CP1W-CIF41 inner bus protocol (Host Link, 7,2,E, 115200 bps), the system response performance is longer than the existing Ethernet Unit. Please consider the FINS command processing time and buffer limitation when using the CP1W-CIF41 Ethernet Option Board.



## 17-9 Buffer Configuration (CP1W-CIF41)

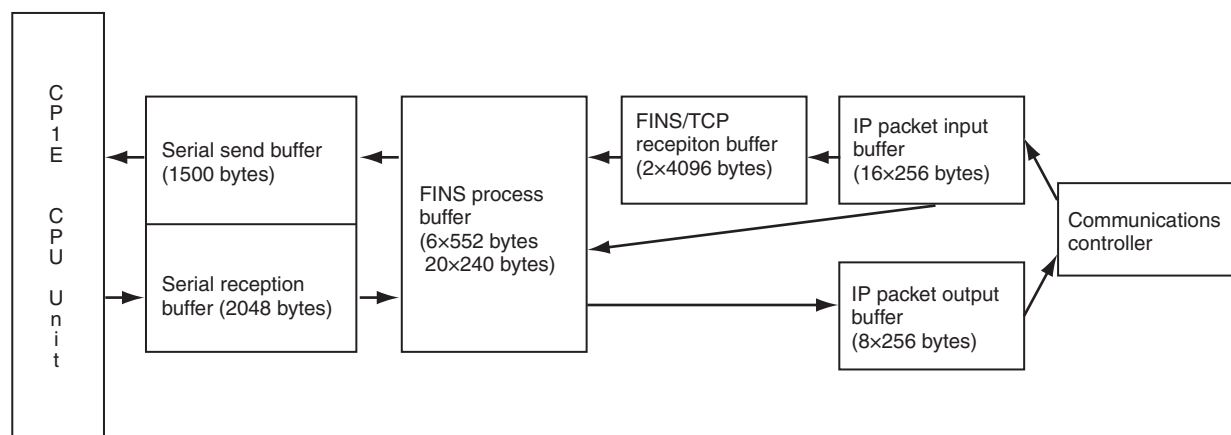



# 18

## Analog Input/Output Option Board

This section describes an overview of the Analog Option Board, describes its installation and setting methods, memory allocations, startup operation, refresh time, troubleshooting and how to use the Analog Option Board.

<b>18-1 General Specifications</b> .....	<b>18-2</b>
<b>18-2 Part Names</b> .....	<b>18-3</b>
<b>18-3 Installation and Setting</b> .....	<b>18-4</b>
18-3-1 Installation .....	18-4
18-3-2 Setting .....	18-4
18-3-3 Removing .....	18-5
<b>18-4 Memory Allocation</b> .....	<b>18-6</b>
18-4-1 CIO Area Allocation .....	18-6
18-4-2 Auxiliary Area Allocation .....	18-6
<b>18-5 Analog Input Option Board</b> .....	<b>18-7</b>
18-5-1 Main Specifications .....	18-7
18-5-2 Analog Input Signal Ranges .....	18-7
18-5-3 Wiring .....	18-8
<b>18-6 Analog Output Option Board</b> .....	<b>18-11</b>
18-6-1 Main Specifications .....	18-11
18-6-2 Analog Output Signal Ranges .....	18-11
18-6-3 Wiring .....	18-12
<b>18-7 Analog I/O Option Board</b> .....	<b>18-15</b>
18-7-1 Main Specifications .....	18-15
18-7-2 Analog I/O Signal Ranges .....	18-15
18-7-3 Wiring .....	18-17
<b>18-8 Startup Operation</b> .....	<b>18-20</b>
<b>18-9 Analog Option Board Refresh Time</b> .....	<b>18-21</b>
<b>18-10 Trouble Shooting</b> .....	<b>18-22</b>
<b>18-11 The Use of Analog Option Board</b> .....	<b>18-23</b>
18-11-1 Procedure .....	18-23
18-11-2 Program Example .....	18-24

## 18-1 General Specifications

CP1 series analog option board units are non-isolated analog units which allow you to easily realize analog input/output function for CP1E N30/40/60 or NA20 CPU Unit (unit version 1.2 or higher).

Analog Option Board		Voltage Input 0V~10V (Resolution: 1/4000)	Current Input 0mA~20mA (Resolution: 1/2000)	Voltage Output 0V~10V (Resolution: 1/4000)
Analog I/O Option Board	CP1W-MAB221	2CH		2CH
Analog Input Option Board	CP1W-ADB21	2CH		---
Analog Output Option Board	CP1W-DAB21V	---		2CH

## 18-2 Part Names

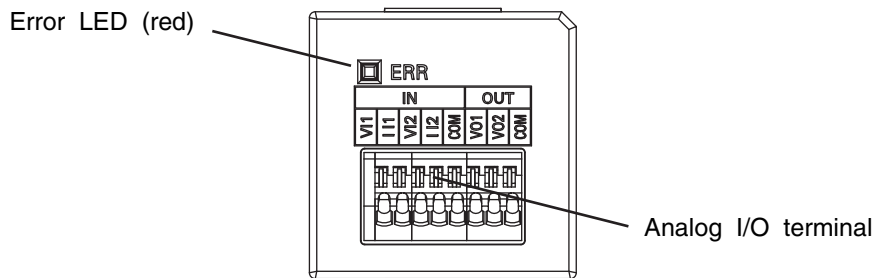

### Terminal Arrangement

- CP1W-ADB21

VI1	II1	VI2	II2	COM
-----	-----	-----	-----	-----

- CP1W-DAB21V

VO1	VO2	COM
-----	-----	-----

- CP1W-MAB221

VI1	II1	VI2	II2	COM	VO1	VO2	COM
-----	-----	-----	-----	-----	-----	-----	-----

**Note** Two COM are connected in inner circuit.

### LED pattern

LED	Color	Description	Status	Remark
ERR	Red	Fault condition indicator	Flash	A communication error with CPU Unit has occurred at the unit.
			Lit	Other errors except the communication error.
			Not lit	Operation is normal.

## 18-3 Installation and Setting

### 18-3-1 Installation

The following processing explains how to install and remove an Analog Option Board.



#### Precautions for Correct Use

Always turn OFF the power supply to the CPU Unit and wait until all the operation indicators go out before installing or removing the analog option board.

Not doing so may result in an unexpected operation.

- 1** Press the up/down lock-levers on both sides of the Option Board slot cover at the same time to unlock the cover, and then pull the cover out.
- 2** Check the alignment to make the corner cut of the Analog Option Board fit in the Option Board slot, and firmly press the Analog Option Board in until it snaps into place.

### 18-3-2 Setting

To use the analog option board on CP1E N30/40/60 or NA20 CPU Unit, it is necessary to set the serial communication settings of the CPU Unit by the USB port.

Connect the CX-Programmer to the CPU Unit, and then change the PLC Settings as follows.

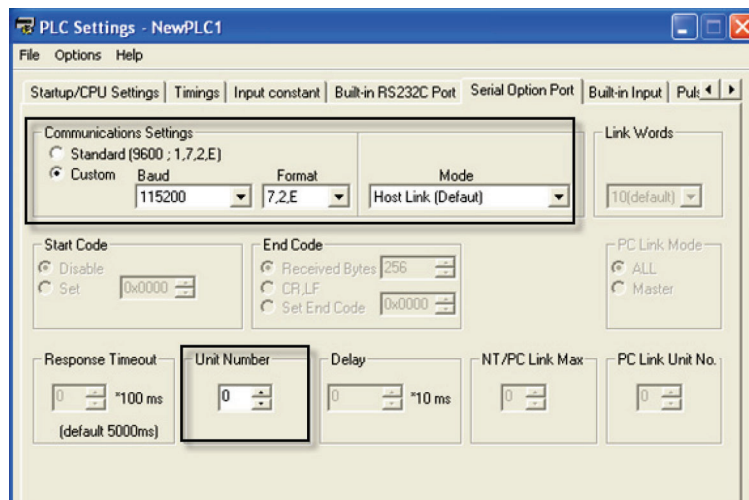

Parameter	Setting
Communications Settings	Select the <i>Custom</i> option, set the baud rate to <i>115200</i> and the format to <i>7,2,E</i> .
Mode	Select <i>Host Link (default)</i> or <i>Host Link</i> .
Unit Number	Select <i>0</i> .



### **Precautions for Correct Use**

---

When the Analog Option Board is applied on the CP1E CPU Unit, it is necessary to set the baud rate to 115,200 and the mode to Host Link.

However, except the settings mentioned above, ERR LED will be lit if the communications is impossible between the CPU Unit and the Analog Option Board. Check and change the settings.

If setting the mode to Host Link and the baud rate to any value except 115,200, change the PLC Settings by USB.

---

### **18-3-3 Removing**

Always turn OFF the power supply to the CPU unit and wait until all the operation indicators go out.

Press the up/down lock-levers on both sides of the Analog Option Board at the same time to unlock the Option Board, and then pull it out.

## 18-4 Memory Allocation

### 18-4-1 CIO Area Allocation

The memory allocation about analog conversion in the CIO area of PLC is shown as the following diagram. The range of the CIO area is CIO80 to CIO89.

The details of allocated CIO channels are described in the following table.

Channel	Contents		
	CP1W-ADB21	CP1W-DAB21V	CP1W-MAB221
CIO80	Analog Input 1	---	Analog Input 1
CIO81	Analog input 2	---	Analog input 2
CIO82 to CIO84	---	---	---
CIO85	---	Analog Output 1	Analog Output 1
CIO86	---	Analog Output 2	Analog Output 2
CIO87 to CIO89	---	---	---

### 18-4-2 Auxiliary Area Allocation

#### Analog Option Unit Status Area

Option board status area: A435 (initial value "0000H")

AR Bits	Content	Error Process
A435.15	I/O option board run state	0: Initial state or unit abnormality state 1: work normally

**Note** A435.15 sets on if analog option board already worked normally. Then user can read A/D input data and write D/A output data.

Output off bit: AR500.15

AR Bits	Content	Error Process
A500.15	Output Off Bit	0: output effective 1: analog option board DA output clear

**Note** This bit will also affect other PLC output channels. Please refer to *A-2 Auxiliary Area Allocations by Address* for more information.



## 18-5 Analog Input Option Board

Each CP1W-ADB21 Analog Input Option Board provides two analog inputs.

- The analog input signal ranges are 0 to 10 V (with a resolution 1/4,000) and 0 to 20 mA (with a resolution 1/2,000).

### 18-5-1 Main Specifications

Item	Specifications	
	Voltage Input	Current Input
Input signal range	0 V to 10 V	0 mA to 20 mA
Max. rated input	0 V to 15 V	0 mA to 30 mA
External input impedance	200 k $\Omega$ min.	Approx. 250 $\Omega$
Resolution	1/4000 (full scale)	1/2000 (full scale)
Overall accuracy	25°C: $\pm 0.5\%$ (full scale) 0 to 55°C: $\pm 1.0\%$ (full scale)	25°C: $\pm 0.6\%$ (full scale) 0 to 55°C: $\pm 1.2\%$ (full scale)
A/D conversion data	0000 to 0FA0 hex	0000 to 07D0 hex
Averaging function	Not supported	
Conversion time	Inner sample time 2ms/point Refresh time refers to <i>18-9 Analog Option Board Refresh Time</i>	
Isolation method	None	
Current consumption	5 VDC: 20 mA max.	

### 18-5-2 Analog Input Signal Ranges

Analog input data is digitally converted according to the input signal range as shown below.

**Note** When the input exceeds the specified range, the A/D conversion data will be fixed at either the lower limit or upper limit.

#### ● 0 to 10 V

The 0 to 10 V range corresponds to the hexadecimal values 0000 to 0FA0 (0 to 4000). The entire data range is 0000 to 0FFF (0 to 4095).

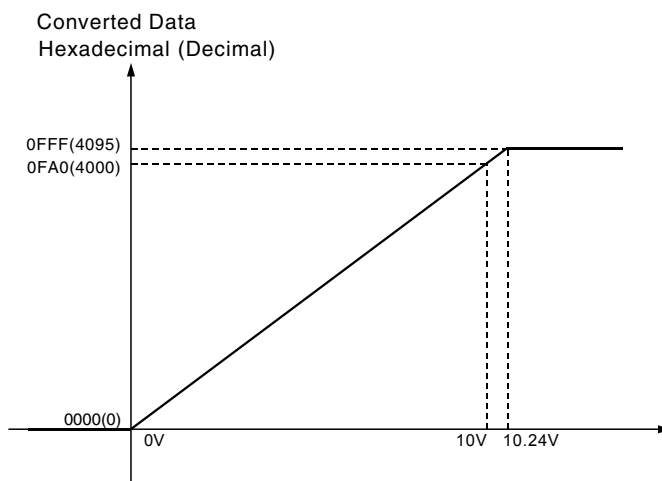

● 0 to 20 mA

The 0 to 20 mA range corresponds to the hexadecimal values 0000 to 07D0 (0 to 2000). The possible data range is 0000 to 0FFF (0 to 4095). But it is strongly suggested that the input current must not exceed 30 mA.

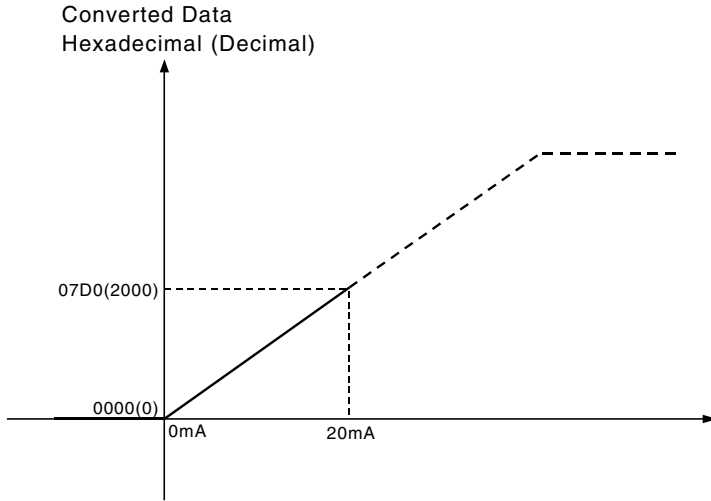

### Analog Input Terminal Arrangement

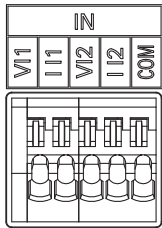

V1	Voltage Input 1
I1	Current Input 1
V2	Voltage Input 2
I2	Current Input 2
COM	Input Common

**Note** When using current inputs, voltage input terminals must be short-circuited with current input terminals.

### 18-5-3 Wiring

#### Internal Circuits

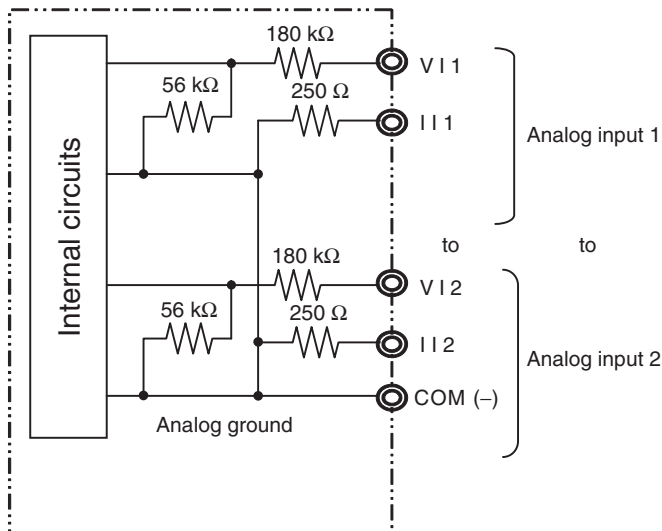

## Applicable Cables and Terminal Wiring

### ● Applicable Cables

Solid wire or ferrules can be used.

- Recommended solid wire

Wire type	Wire size
Solid Wire	0.2mm <sup>2</sup> to 0.5mm <sup>2</sup> (AWG24 to AWG20)

- Recommended ferrules

Manufacturer	Model	Applicable wire
Phoenix Contact	AI-0.25-12	0.2mm <sup>2</sup> (AWG24)

**Note** Do not connect bare stranded wires directly to terminals.

### ● Terminal Wiring

When wiring the analog I/O terminal block, treat either solid or stranded wires directly.

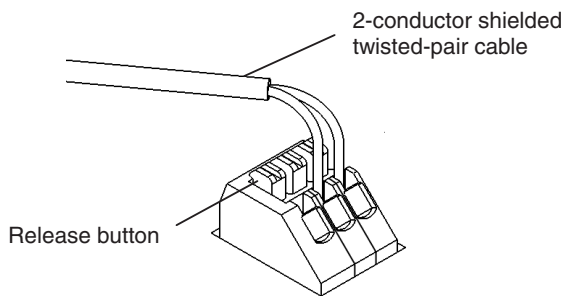

- To make the connection, press the release button in with a small flat blade screwdriver and push the line in while the lock is released. Remove the screwdriver and lock it inside.
- To disconnect the wiring, press the release button in with a small flat blade screwdriver and pull the line out while the lock is released.

**Note 1** Ferrules without plastic sleeve cannot be used.

- 2 When using stranded wire, twist the core so that the barbed wires cannot protrude.
- 3 Do not solder-plate the end of cable.

The screwdriver shown below is recommended for wiring.

Model	Manufacturer
SZS 0.4×2.5	Phoenix Contact

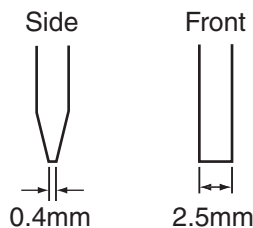

## Wiring for Analog Inputs

To prevent noise, 2-core shielded twisted-pair cable should be used.

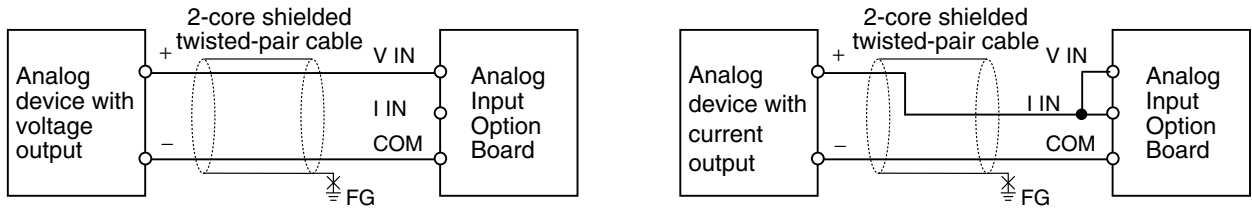

- Note 1** When an input is not being used, short the V IN, I IN and COM terminals.
- 2** Separate wiring from power lines (AC power supply lines, high-voltage lines, etc.)
- 3** When there is noise in the power supply line, install a noise filter on the input section and the power supply.



### Precautions for Correct Use

When connecting the analog option board to an outside analog device, either ground the 0 V side of the PLC's external power supply or do not ground the PLC's external power supply at all. Otherwise the PLC's external power supply may be shorted depending on the connection methods of the outside analog device. **DO NOT** ground the 24 V side of the PLC's external power supply, as shown in the following diagram.

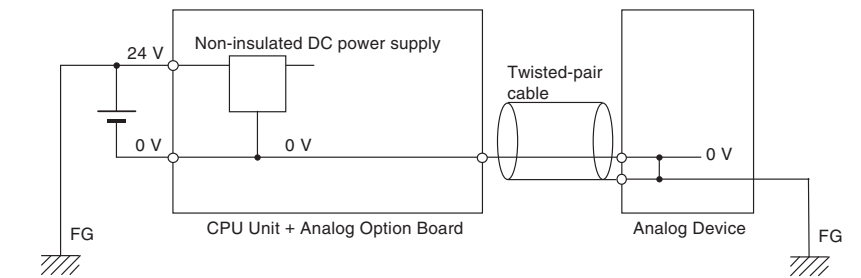

## 18-6 Analog Output Option Board

Each CP1W-DAB21V Analog Output Option Board provides two analog outputs.

- The analog output signal range is 0 to 10 V (with a resolution 1/4,000).

### 18-6-1 Main Specifications

Item	Specifications	
	Voltage Output	Current Output
Output signal range	0 V to 10 V	---
External output allowable load resistance	2 k $\Omega$ min.	---
External output impedance	0.5 $\Omega$ max.	---
Resolution	1/4,000 (full scale)	---
Overall accuracy	25°C: $\pm 0.5\%$ 0 to 55°C: $\pm 1.0\%$	---
D/A conversion data	0000 to 0FA0 hex	---
Conversion time	Inner conversion time 2ms/point Refresh time refers to <i>18-9 Analog Option Board Refresh Time</i>	
Isolation method	None	
Current consumption	5 VDC: 60 mA max.	

### 18-6-2 Analog Output Signal Ranges

The analog values depend on the output signal range, as shown in the following diagram.

**Note** When the output exceeds the specified range, the output signal will be fixed at either the lower limit or upper limit.

#### ● 0 to 10 V

The hexadecimal values 0000 to 0FA0 (0 to 4000) correspond to an analog voltage range of 0 to 10 V. The entire output range is 10 to 10.24 V.

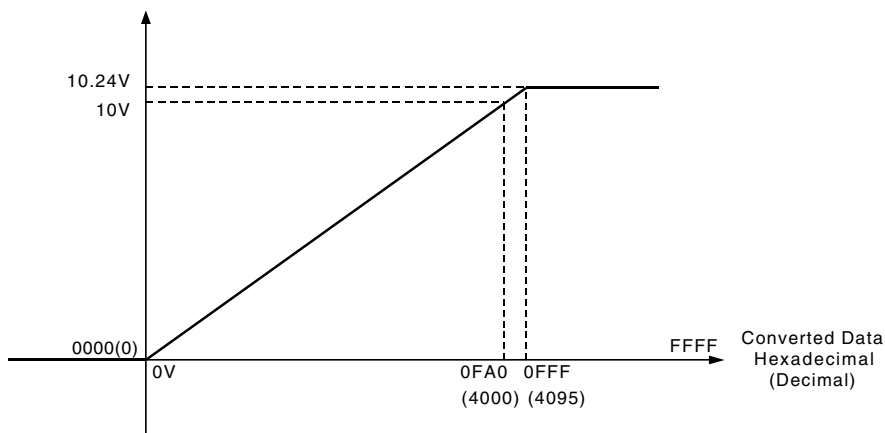

## Analog Output Terminal Arrangement



VO1	Voltage Output 1
VO2	Voltage Output 2
COM	Output Common

### 18-6-3 Wiring

#### Internal Circuits

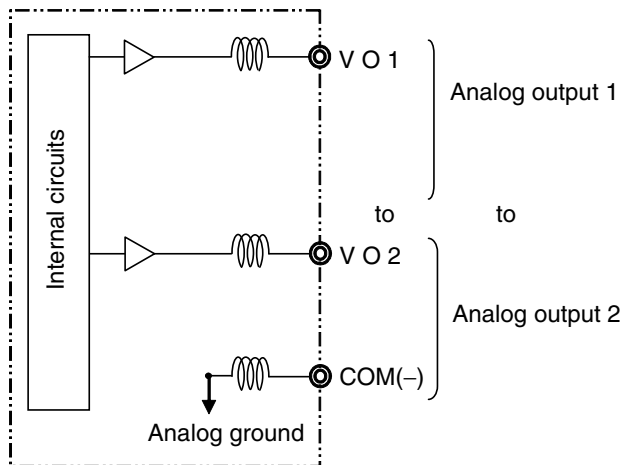

#### Applicable Cables and Terminal Wiring

##### ● Applicable Cables

Solid wire or ferrules can be used.

- Recommended solid wire

Wire type	Wire size
Solid Wire	0.2mm <sup>2</sup> to 0.5mm <sup>2</sup> (AWG24 to AWG20)

- Recommended ferrules

Manufacturer	Model	Applicable wire
Phoenix Contact	AI-0.25-12	0.2mm <sup>2</sup> (AWG24)

**Note** Do not connect bare stranded wires directly to terminals.

## ● Terminal Wiring

When wiring the analog I/O terminal block, treat either solid or stranded wires directly.

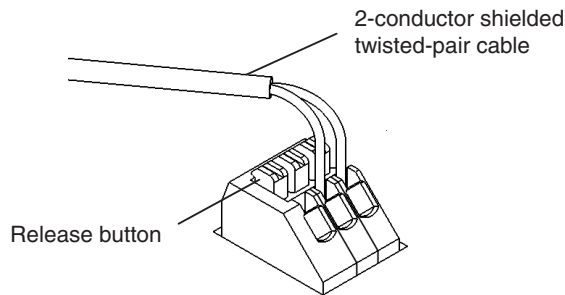

- To make the connection, press the release button in with a small flat blade screwdriver and push the line in while the lock is released. Remove the screwdriver and lock it inside.
- To disconnect the wiring, press the release button in with a small flat blade screwdriver and pull the line out while the lock is released.

**Note 1** Ferrules without plastic sleeve cannot be used.

**2** When using stranded wire, twist the core so that the barbed wires cannot protrude.

**3** Do not solder-plate the end of cable.

The screwdriver shown below is recommended for wiring.

Model	Manufacturer
SZS 0.4×2.5	Phoenix Contact

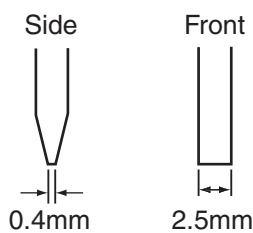

## Wiring for Analog Outputs

To prevent noise, 2-core shielded twisted-pair cable should be used.

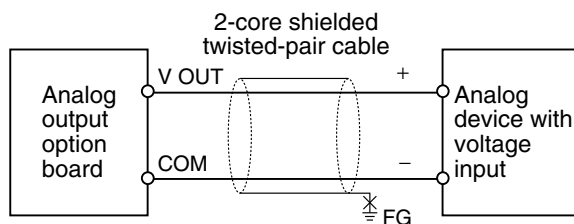

**Note 1** Separate wiring from power lines (AC power supply lines, high-voltage lines, etc.)

**2** When there is noise in the power supply line, install a noise filter on the input section and the power supply.

**3** When external power is supplied, or when the power is interrupted, there may be a pulse status analog output of up to 1 ms. If this status is a problem, take the following measures.

- Turn ON the power to the CP1E N30/40/60 or NA20 CPU Unit, check the operation status, and then turn ON the power at the load.
- Turn OFF the power to the load and then turn OFF the power to the CP1E N30/40/60 or NA20 CPU Unit.

**Precautions for Correct Use**

When connecting the analog option board to an outside analog device, either ground the 0 V side of the PLC's external power supply or do not ground the PLC's external power supply at all. Otherwise the PLC's external power supply may be shorted depending on the connection methods of the outside analog device. **DO NOT** ground the 24 V side of the PLC's external power supply, as shown in the following diagram.

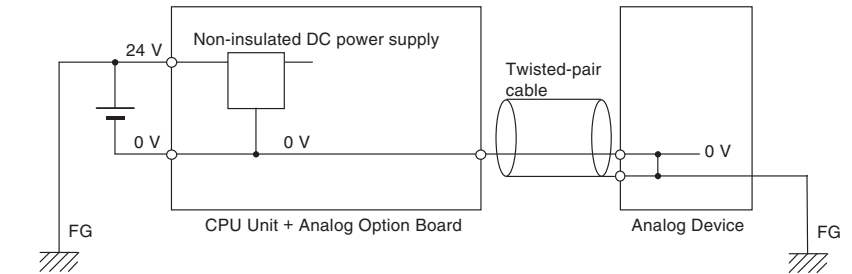



## 18-7 Analog I/O Option Board

Each CP1W-MAB221 Analog I/O Option Board provides two analog inputs and two analog outputs.

- The analog input signal ranges are 0 to 10 V (with a resolution 1/4,000) and 0 to 20 mA (with a resolution 1/2,000).
- The analog output signal ranges are 0 to 10 V (with a resolution 1/4,000).

### 18-7-1 Main Specifications

Item		Specifications	
		Voltage I/O	Current I/O
Analog Input Section	Input signal range	0 V to 10 V	0 mA to 20 mA
	Max. rated input	0 V to 15 V	0 mA to 30 mA
	External input impedance	200 k $\Omega$ min.	Approx. 250 $\Omega$
	Resolution	1/4,000 (full scale)	1/2,000 (full scale)
	Overall accuracy	25°C: $\pm 0.5\%$ (full scale) 0 to 55°C: $\pm 1.0\%$ (full scale)	25°C: $\pm 0.6\%$ (full scale) 0 to 55°C: $\pm 1.2\%$ (full scale)
	A/D conversion data	0000 to 0FA0 hex	0000 to 07D0 hex
	Averaging function	Not supported	
Analog Output Section	Output signal range	0 V to 10 V	---
	External output allowable load resistance	2 k $\Omega$ min.	---
	External output impedance	0.5 $\Omega$ max.	---
	Resolution	1/4,000 (full scale)	---
	Overall accuracy	25°C: $\pm 0.5\%$ 0 to 55°C: $\pm 1.0\%$	---
	D/A conversion data	0000 to 0FA0 hex	---
Conversion time	Inner conversion time 6ms (4CH total) Refresh time refers to <i>18-9 Analog Option Board Refresh Time</i>		
Isolation method	None		
Current consumption	5 VDC: 80 mA max.		

### 18-7-2 Analog I/O Signal Ranges

The analog values depend on the I/O signal ranges, as shown in the following diagrams.

**Note** When the input exceeds the specified range, the A/D conversion data will be fixed at either the lower limit or upper limit.  
When the output exceeds the specified range, the output signal will be fixed at either the lower limit or upper limit.

#### Analog Input Signal Ranges

##### ● 0 to 10 V

The 0 to 10 V range corresponds to the hexadecimal values 0000 to 0FA0 (0 to 4000). The entire data range is 0000 to 0FFF (0 to 4095).

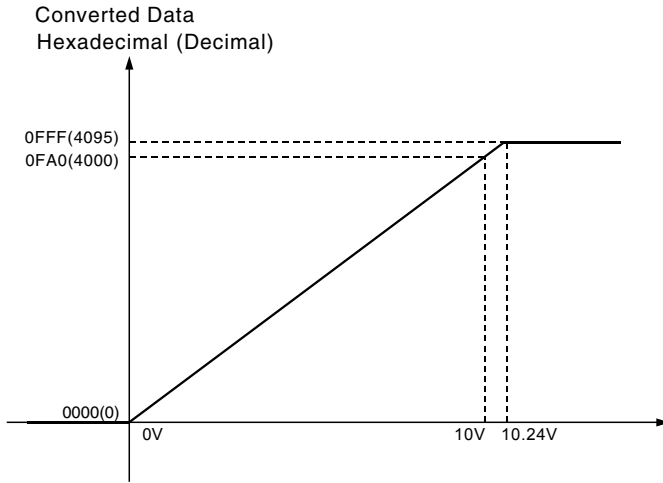

● 0 to 20 mA

The 0 to 20 mA range corresponds to the hexadecimal values 0000 to 07D0 (0 to 2000). The possible data range is 0000 to 0FFF (0 to 4095). But it is strongly suggested that the input current mustn't exceed 30 mA.

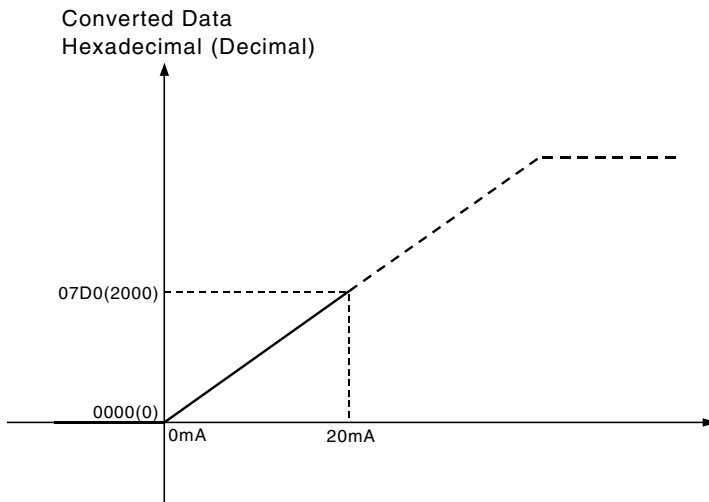

## Analog Output Signal Ranges

● 0 to 10 V

The hexadecimal values 0000 to 0FA0 (0 to 4000) correspond to an analog voltage range of 0 to 10 V. The entire output range is 10 to 10.24 V.

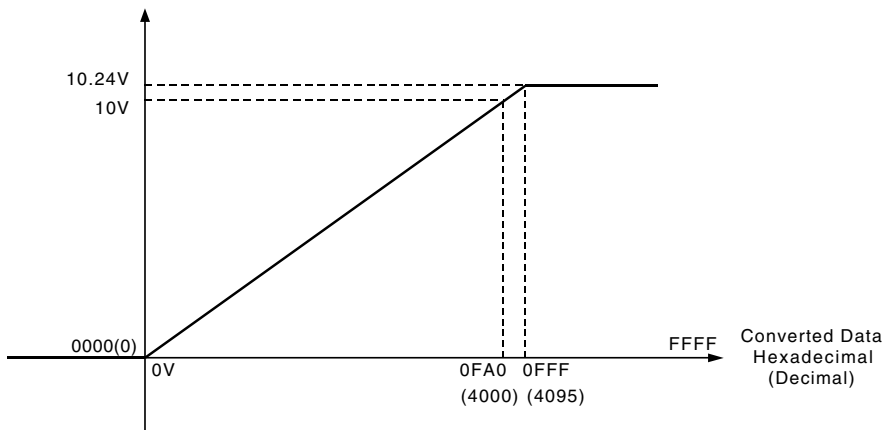

## Analog I/O Terminal Arrangement

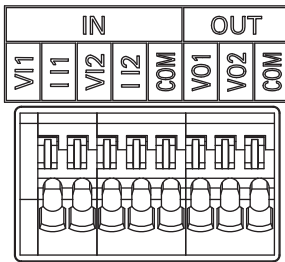

V11	Voltage Input 1
I11	Current Input 1
V12	Voltage Input 2
I12	Current Input 2
COM	Analog I/O Common
V01	Voltage Output 1
V02	Voltage Output 2
COM	Analog I/O Common

**Note** When using current inputs, voltage input terminals must be short-circuited with current input terminals.

### 18-7-3 Wiring

#### Internal Circuits

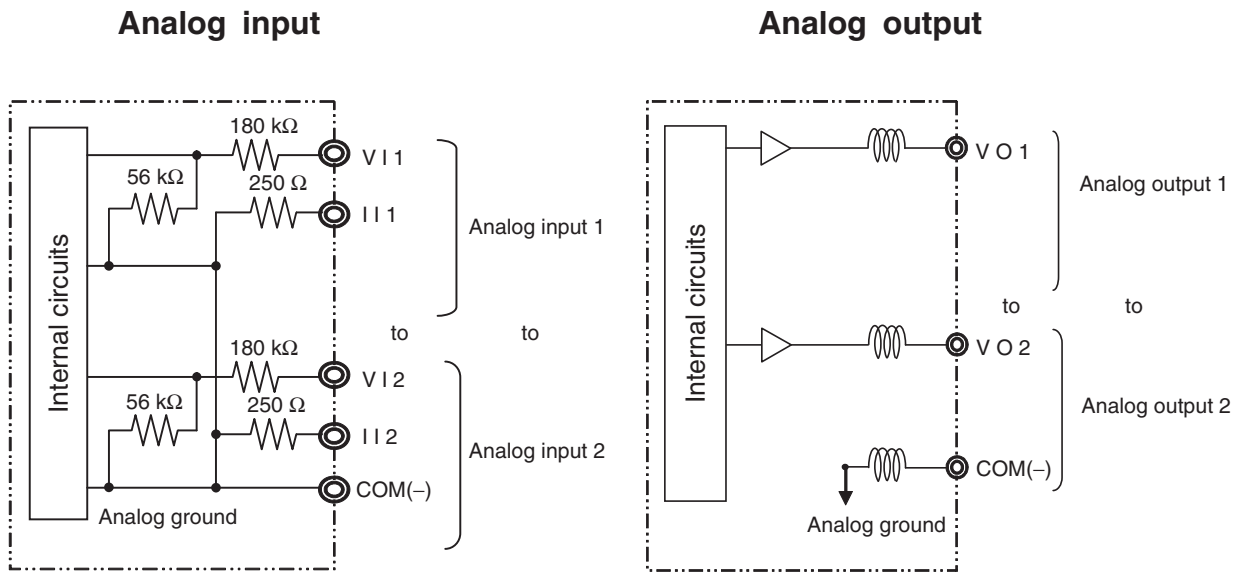

#### Applicable Cables and Terminal Wiring

##### ● Applicable Cables

Solid wire or ferrules can be used.

- Recommended solid wire

Wire type	Wire size
Solid Wire	0.2mm <sup>2</sup> to 0.5mm <sup>2</sup> (AWG24 to AWG20)

- Recommended ferrules

Manufacturer	Model	Applicable wire
Phoenix Contact	AI-0.25-12	0.2mm <sup>2</sup> (AWG24)

**Note** Do not connect bare stranded wires directly to terminals.

● **Terminal Wiring**

When wiring the analog I/O terminal block, treat either solid or stranded wires directly.

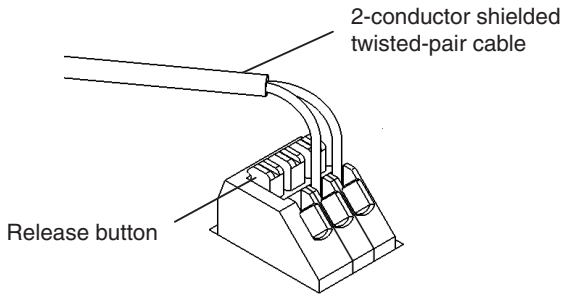

- To make the connection, press the release button in with a small flat blade screwdriver and push the line in while the lock is released. Remove the screwdriver and lock it inside.
- To disconnect the wiring, press the release button in with a small flat blade screwdriver and pull the line out while the lock is released.

**Note 1** Ferrules without plastic sleeve cannot be used.

**2** When using stranded wire, twist the core so that the barbed wires cannot protrude.

**3** Do not solder-plate the end of cable.

The screwdriver shown below is recommended for wiring.

Model	Manufacturer
SZS 0.4×2.5	Phoenix Contact

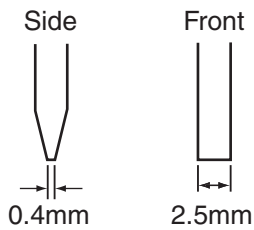

**Wiring for Analog I/O**

To prevent noise, 2-core shielded twisted-pair cable should be used.

● **Wiring for Analog Inputs**

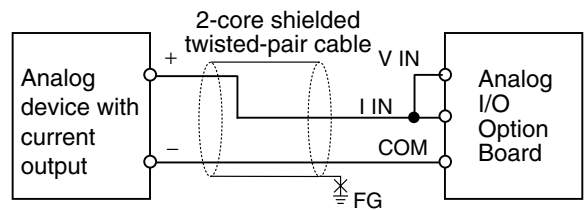
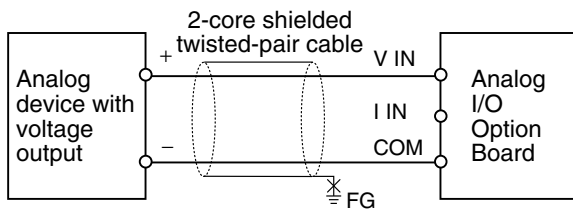

## ● Wiring for Analog Outputs

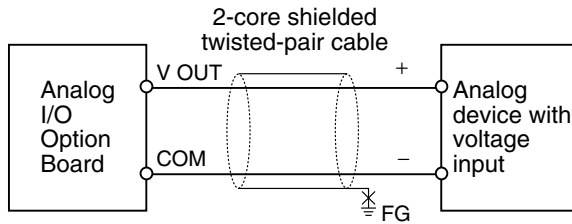

**Note 1** When an input is not being used, short the V IN, I IN and COM terminals.

- 2 Separate wiring from power lines (AC power supply lines, high-voltage lines, etc.)
- 3 When there is noise in the power supply line, install a noise filter on the input section and the power supply.
- 4 When external power is supplied, or when the power is interrupted, there may be a pulse status analog output of up to 1 ms. If this status is a problem, take the following measures.
  - Turn ON the power to the CP1E N30/40/60 or NA20 CPU Unit, check the operation status, and then turn ON the power at the load.
  - Turn OFF the power to the load and then turn OFF the power to the CP1E N30/40/60 or NA20 CPU Unit.



### Precautions for Correct Use

When connecting the analog option board to an outside analog device, either ground the 0 V side of the PLC's external power supply or do not ground the PLC's external power supply at all. Otherwise the PLC's external power supply may be shorted depending on the connection methods of the outside analog device. DO NOT ground the 24 V side of the PLC's external power supply, as shown in the following diagram.

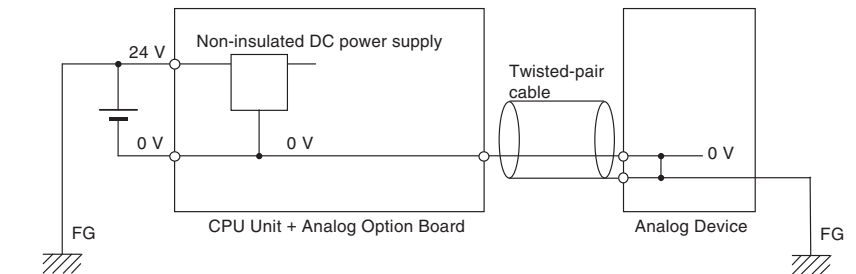

## 18-8 Startup Operation

---

After the power is turned ON, analog option board starts the initialization process. If the initialization finishes normally, the initialization completed flag in related status area (Refer to *18-4-2 Auxiliary Area Allocation: A435*) will be set. Therefore, status monitor content must be added in ladder. Only when the initialization process has finished, user can use the A/D conversion data or write the output data.

The analog input data will be 0000 until the initial processing is completed.

It takes about 1.9 seconds from the CP1E CPU Unit running to the Analog Option Board initialization completed.

## 18-9 Analog Option Board Refresh Time

The inner conversion time of the Analog Option Board is 2ms/point. The refresh time of data conversion in the CPU Unit is shown as follows.

The refresh time differs in accordance with the cycle time.

Below are **typical** values for reference only.

Analog Option Board	Cycle time (ms)		
	1ms	10ms	20ms
CP1W-ADB21	40±30%	50±30%	80±30%
CP1W-DAB21V	30±40%	40±50%	70±40%
CP1W-MAB221(AD)	60±40%	80±60%	100±50%
CP1W-MAB221(DA)	40±80%	60±60%	90±50%

# 18-10 Trouble Shooting

## Trouble-shooting with Indicators

ERR Indicator	Error	Probably Cause	Correction	Auxiliary Area Allocations	AD/DA function
Lit	CPU Unit service monitoring error	Service from the CPU Unit was not completed within the fixed interval.	Check and correct the CPU Unit's operating environment. Check serial communication setting.	A435.15 will be OFF	AD/DA conversion will stop. The analog input conversion data stops refreshing and the analog output conversion output becomes 0V.
	Option board error	An error occurred in the Analog Option Board.	Restart the CPU Unit. Replace the Analog Option Board if the error recurs.		
Flashing	Communication error	The communication between PLC is out of service	Check if PLC is running normally.	A435.15 will be OFF	AD/DA conversion will stop. The analog input conversion data stops refreshing and the analog output conversion output becomes 0V. If the communication recovers from error, the AD/DA conversion will start again.



# 18-11 The Use of Analog Option Board

## 18-11-1 Procedure

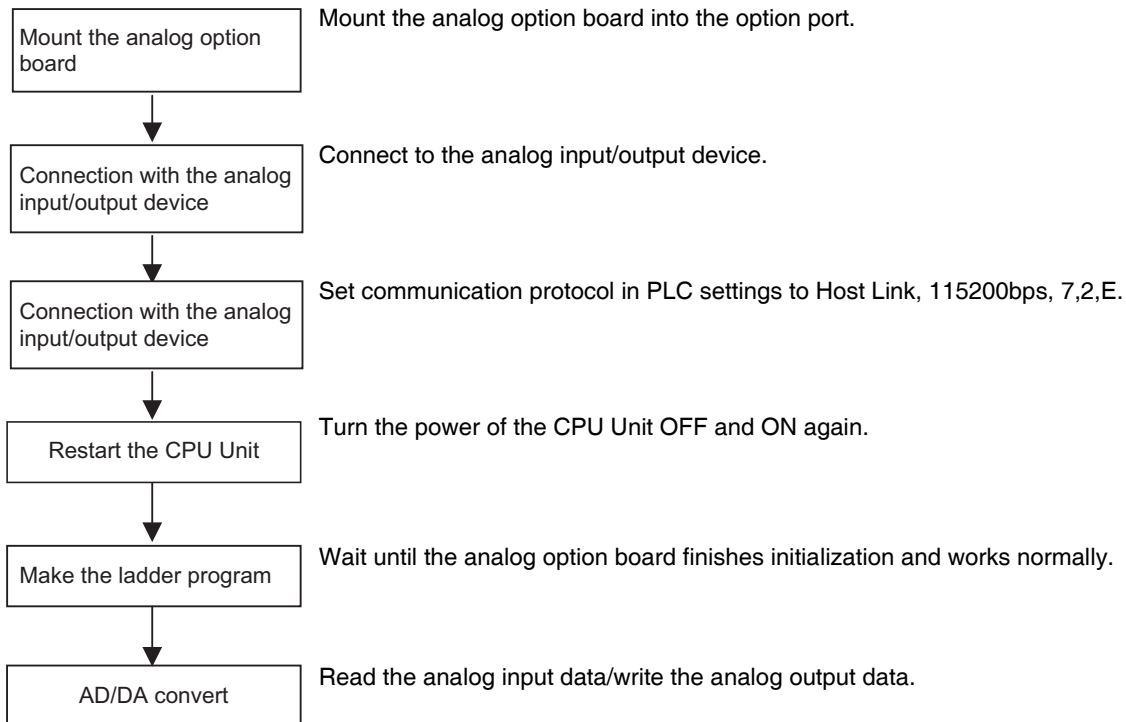

**Note 1** If PLC communication protocol setting is error, the option board will always try to link the PLC, and the error LED will be lit.

**2** Only when the initialization process has finished (AR435.15 sets on), user can use the A/D conversion data or write the D/A output data.

### 18-11-2 Program Example

Use the analog option board to carry out 2CH AD inputs and 1CH DA output at the same time.

The ranges of AD/DA are as follows:

Analog input1: 0~10V

Analog input2: 0~20mA

Analog output1: 0~10V

System composing: CP1E-N□□D□-□ + CP1W-MAB221

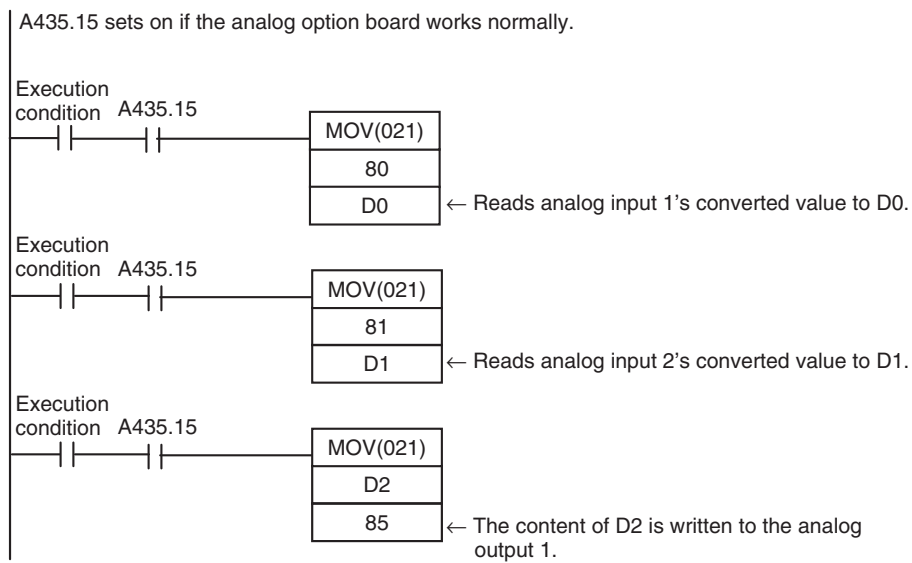

# 19

## Programming Device Operations

This section describes the use of the CX-Programmer to create a ladder programs to operate the CP1E, transfer the program to the CP1E, and debug the program. It also describes other basic functions of the CX-Programmer.

---

<b>19-1 Programming Devices Usable with the CP1E</b> .....	<b>19-2</b>
<b>19-2 Overview of CX-Programmer</b> .....	<b>19-4</b>
19-2-1 CX-Programmer .....	19-4
19-2-2 CX-Programmer Flow from Startup to Operation .....	19-4
19-2-3 Help .....	19-7
<b>19-3 Creating a Ladder Program</b> .....	<b>19-8</b>
19-3-1 Inputting a Ladder Program .....	19-8
19-3-2 Saving and Reading Ladder Programs .....	19-15
19-3-3 Editing Ladder Programs .....	19-16
<b>19-4 Connecting Online to the CP1E and Transferring the Program</b> .....	<b>19-19</b>
19-4-1 Connecting Online .....	19-19
19-4-2 Changing Operating Modes .....	19-20
19-4-3 Transferring a Ladder Program and the PLC Setup .....	19-21
19-4-4 Starting Operation .....	19-22
<b>19-5 Online Monitoring and Debugging</b> .....	<b>19-24</b>
19-5-1 Monitoring Status .....	19-24
19-5-2 Force-set/Reset Bits .....	19-26
19-5-3 Online Editing .....	19-27

# 19-1 Programming Devices Usable with the CP1E

The Programming Devices that can be used with the CP1E are listed in the following table.

Product	Model	Compatible CX-Programmer versions	Unit version of CP1E CPU Unit	Support for Smart Input	Saved program file extension	Reference	Applicable CPU Unit
CX-Programmer (CX-One)	WS02-CXPC 1-V8 CXONE-AL0 1C-V3	Version 8.2 or higher (See note.)	Version 1.□	Not supported	.CXP	Refer to the <i>CX-Programmer Operation Manual</i> (Cat. No. W446).	CP1E-□20□D□-□ CP1E-□30□D□-□ CP1E-□40□D□-□
	WS02-CXPC 1-V9 CXONE-AL0 1C-V4	Version 9.03 or higher	Version 1.□	Supported			CP1E-E10□D□-□ CP1E-□20□D□-□ CP1E-□30□D□-□ CP1E-□40□D□-□ CP1E-N60□D□-□ CP1E-NA20□D□-□
	CXONE-AL0 1C-V4	Version 9.42 or higher	Version 1.□	Supported			All units are supported
		Version 9.6 or higher	Version 3.□	Supported			
Micro PLC Edition CX-Programmer (CX-One Lite)	WS02-CXPC 2-V8 CXONE-LT0 1C-V3	Version 8.2 or higher	Version 1.□	Not supported	.CXP	Described in this section.	CP1E-□20□D□-□ CP1E-□30□D□-□ CP1E-□40□D□-□
	WS02-CXPC 1-V9 CXONE-LT0 1C-V4	Version 9.03 or higher	Version 1.□	Supported			CP1E-E10□D□-□ CP1E-□20□D□-□ CP1E-□30□D□-□ CP1E-□40□D□-□ CP1E-N60□D□-□ CP1E-NA20□D□-□
	WS02-CXPC 2-V9 CXONE-LT0 1C-V4	Version 9.42 or higher	Version 1.□	Supported			All units are supported
CX-Programmer for CP1E	WS02-CXPC 3	Version 1.0	Version 1.□	Supported	.CXE		CP1E-□20□D□-□ CP1E-□30□D□-□ CP1E-□40□D□-□

**Note 1** To use CX-Programmer version 8.2 with a CP1E CPU Unit, the CX-One version 3 auto-update must be installed.

**2** Use the CX-Programmer version 9.12 or higher, when CP1W-CIF41 is applied.



## Precautions for Correct Use

- This section describes the unique applications and functions of the Micro PLC Edition CX-Programmer version 9.03 or higher/CX-Programmer for CP1E. In the remainder of this section, “CX-Programmer” refers to the Micro PLC Edition CX-Programmer version 9.03 or higher/CX-Programmer for CP1E.
- When using the full version of CX-Programmer provided in CX-One, refer to the *CX-Programmer Operation Manual* (Cat. No. W446).
- A Programming Console cannot be used for the CP1E. Use the CX-Programmer.
- The windows described in this section are the windows using the CX-Programmer for CP1E. When using the CX-Programmer or the Micro PLC Edition CX-Programmer, the specification may be different. Check the window specifications sufficiently. Refer to the *CX-Programmer Operation Manual* (Cat. No. W446) for details.

- The CX-Programmer for CP1E and CX-Programmer (CX-One/CX-One Lite) can be used at the same time.
- The CX-Programmer (CX-One/CX-One Lite) and the CX-Programmer for CP1E can be installed on the same computer and both applications can be run at the same time.

### ● Using Project Files Saved with the CX-Programmer (.CXP) on the CX-Programmer for CP1E

The CX-Programmer for CP1E cannot open a .CXP project created on the CX-Programmer (CX-One/CX-One Lite). Use programming from a project saved in a .CXP file on the CX-Programmer for CP1E according to the following procedure.

- 1** Start the CX-Programmer (CX-One/CX-One Lite) and CX-Programmer for CP1E together.
- 2** Copy the rungs of the program to be used from the Ladder Programming Window of the CX-Programmer (CX-One/CX-One Lite), and paste them into the CX-Programmer for CP1E.



#### Additional Information

---

Files created with the CX-Programmer for CP1E (.CXE) can be opened with CX-Programmer version 8.2 and higher.

---

## 19-2 Overview of CX-Programmer

This section describes the preparations that must be completed before a ladder program can be created, including connecting the CP1E to the computer and installing the USB driver.

### 19-2-1 CX-Programmer

The CX-Programmer is a programming application for creating the ladder programs that are executed in a CP1E CPU Unit.

In addition to ladder program creation, the CX-Programmer also has functions that are needed to set up and operate the CP1E, including functions for debugging ladder programs, displaying addresses and present values, monitoring, setting the connected PLC, programming, and monitoring.

The CX-Programmer has fewer sub-menus, making it relatively simple.

The installation of the CX-Programmer is described in 4-1-5 *Installing the Software in the CP1E CPU Unit Hardware User's Manual* (Cat. No. W479).

For details on the operation of the CX-Programmer, refer to the CX-Programmer Online Help.

### 19-2-2 CX-Programmer Flow from Startup to Operation

The flow of using the CX-Programmer from startup through starting PLC operation is shown below.

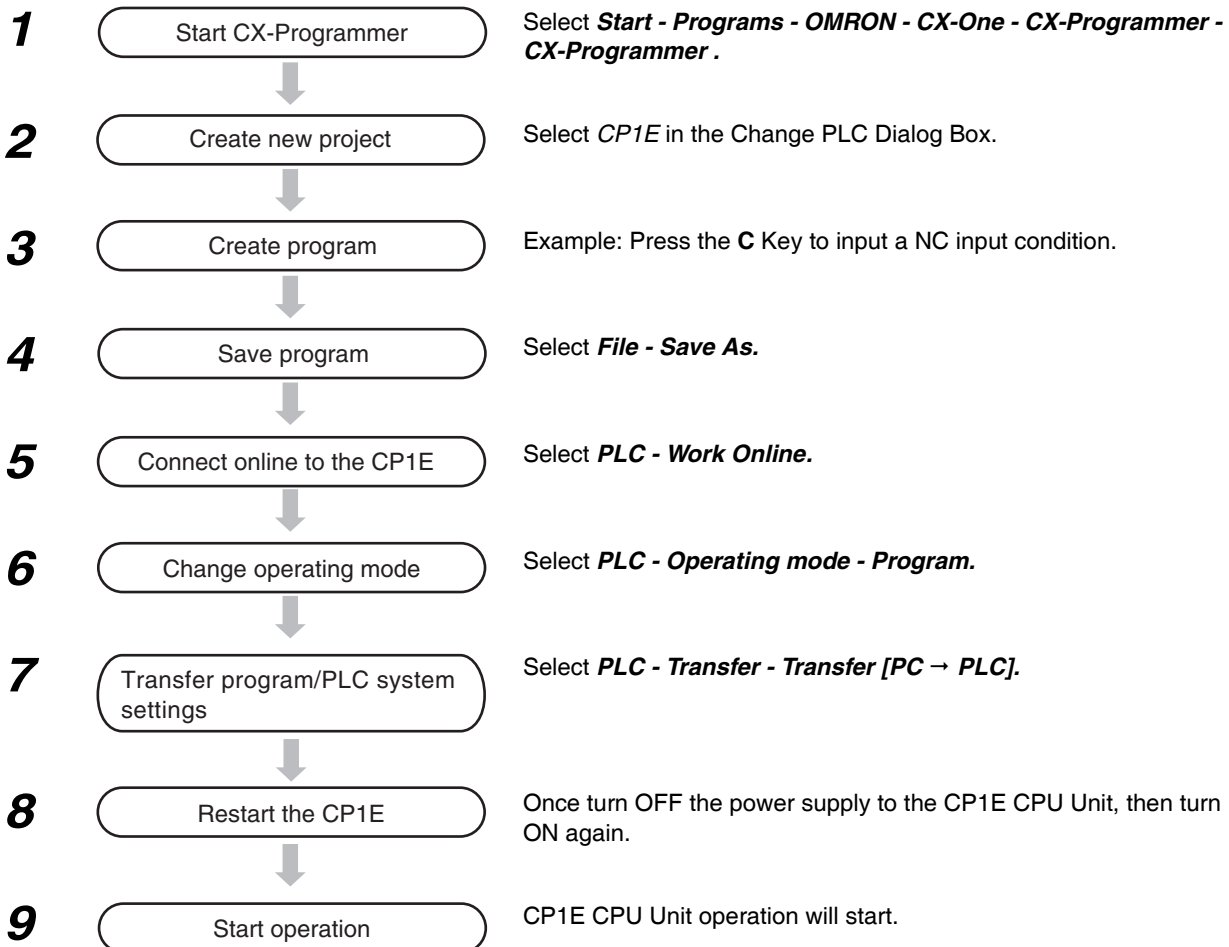

## Start CX-Programmer

Select **Start - Programs - OMRON - CX-One - CX-Programmer**.

The CX-Programmer will start.

The title display will appear, followed by the Main Window.

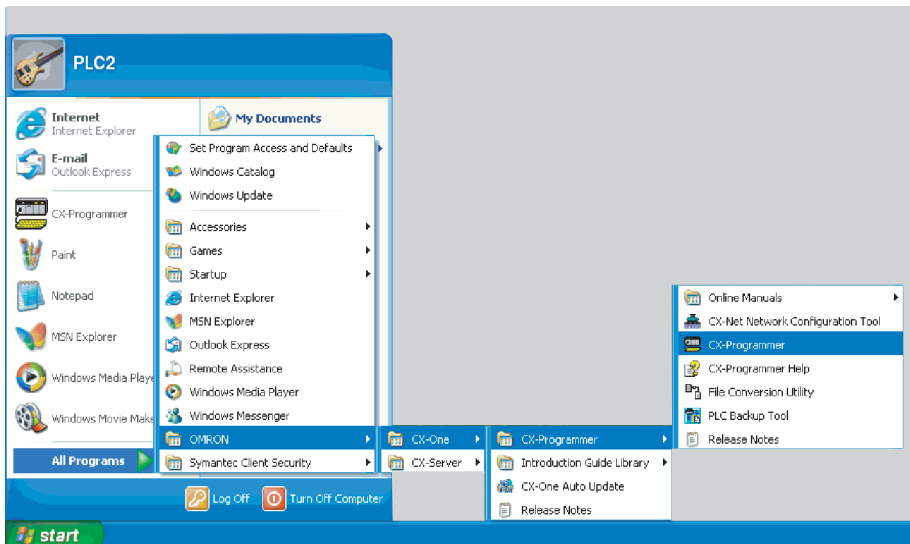

## Names and Functions of Parts of the Main Window

This section describes the names and functions of each part of the Main Window of the CX-Programmer. For details on the functions and operation of CX-Programmer, refer to the CX-Programmer Online Help.

### ● Main Window

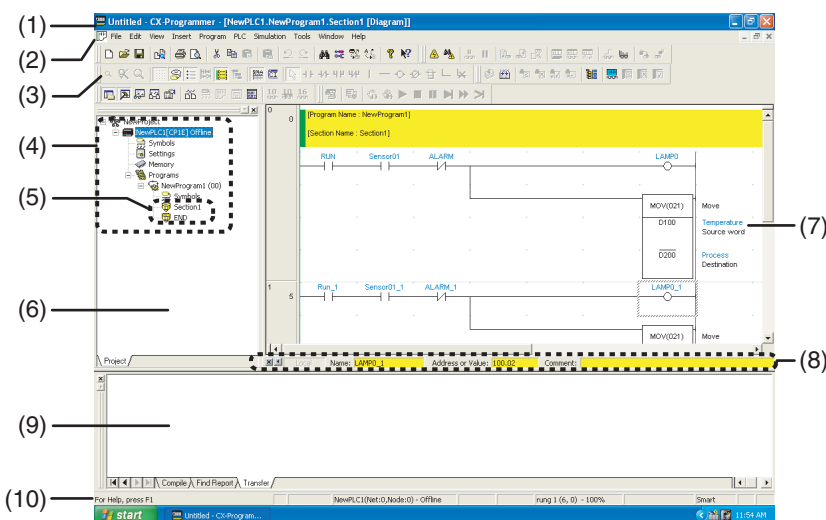

- (1) Title Bar  
Displays the name of the project.
- (2) Main Menu  
Displays the menus from which commands are selected.
- (3) Toolbar  
Displays the icons for executing commands.

- (4)Project Tree and (6) Project Workspace  
Used to manage programs and settings.
- (5)Sections  
Allow ladder programming to be split up into a number of parts.
- (7)Ladder Section Window  
A window that is used to create and edit ladder programs.
- (8)I/O Comment Bar  
Displays the name, address, value, and I/O comment of the symbol selected with the cursor.
- (9)Output Window  
Displays messages, such as search results and errors.
- (10)Status Bar  
Displays information such as the PLC name, online/offline status, and position of the active cell.

● **Ladder Section Window**

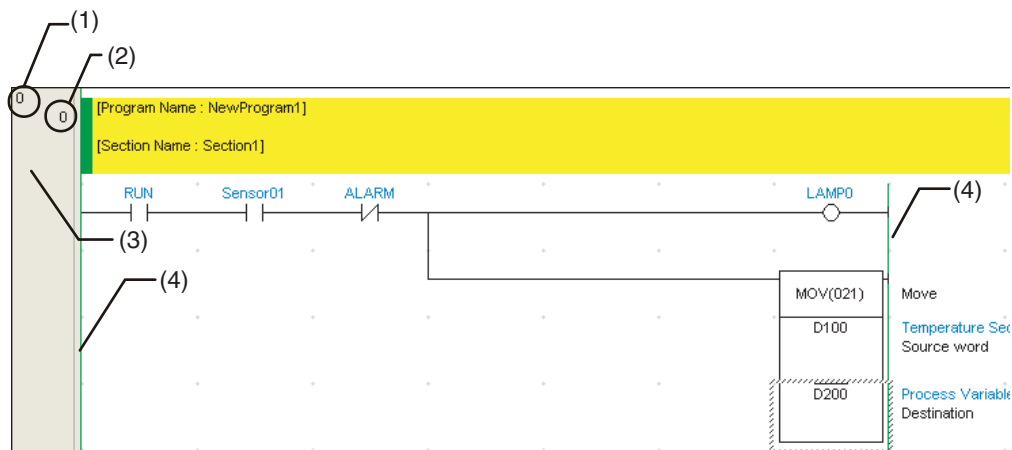

- (1)Rung Number
- (2)Program Address
- (3)Rung Header  
If a rung is incomplete, a red line will be displayed on the right side of the rung header.
- (4)Bus Bar



## 19-2-3 Help

The CX-Programmer Help describes all the operations of CX-Programmer. It provides an introduction to the various windows and panes and describes basic operations, ladder program creation, and monitoring. It also describes each of the instructions, including operand notation and contents.

### Accessing CX-Programmer Help

Press the **F1** Key from the CX-Programmer.

The Help Window will be displayed.

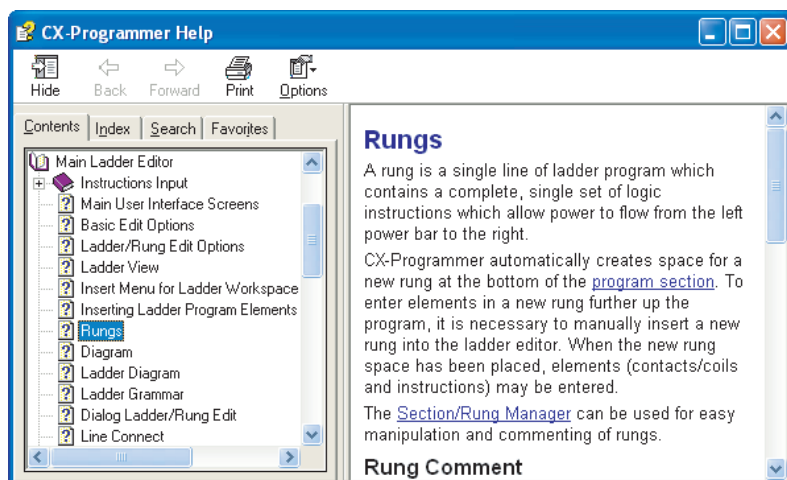

### Accessing the CX-Programmer Instruction Reference

For an explanation of an instruction used in ladder programming, refer to the CX-Programmer Instruction Reference.

- **Displaying the Instruction Reference from the Main Menu of the CX-Programmer**

Select *Instruction Reference - CP1E* from the Help Menu.

The CX-Programmer Instruction Reference Window will be displayed.

- **Displaying the Instruction Reference while Creating a Ladder Program**

While creating an instruction in a ladder program in Smart Input Mode, press the **F1** Key to display the Instruction Reference page for the instruction being edited.

### Accessing the CP1E I/O Memory Reference

To check the CP1E I/O memory address map from the CX-Programmer, select *I/O Memory Reference* from the Help Menu.

## 19-3 Creating a Ladder Program

This section describes the use of CX-Programmer to create a ladder program.

### 19-3-1 Inputting a Ladder Program

This section shows how to input a ladder program for an example application using the CX-Programmer commands.

#### Creating a New Project

To use the CX-Programmer, the first step is to create a new project. To create a new project, we must specify the PLC type and CPU Unit model for which the ladder program and data to be created will be used.

- 1 Select **New** from the File Menu. The Change PLC Dialog Box will be displayed.

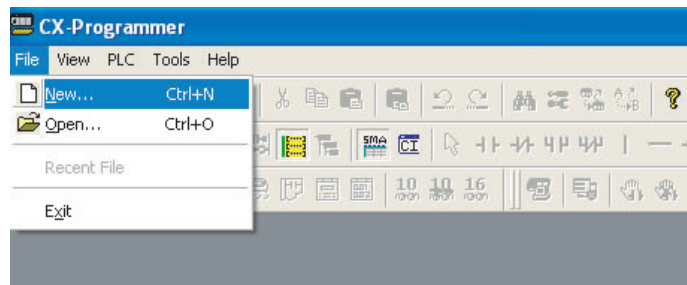

- 2 The CP1E will already be selected as the Device Type.

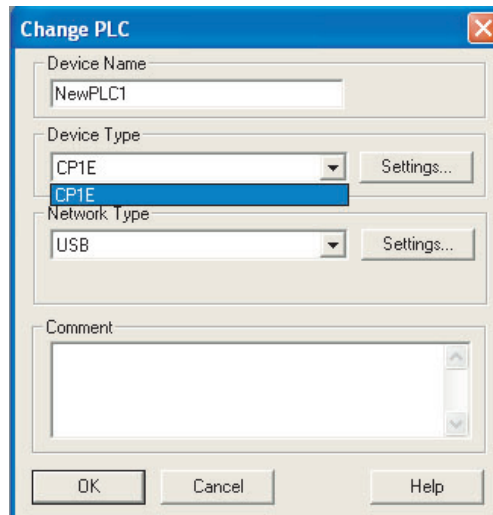

- 3 Click the **Settings** Button.  
The PLC Type Settings Dialog Box will be displayed.

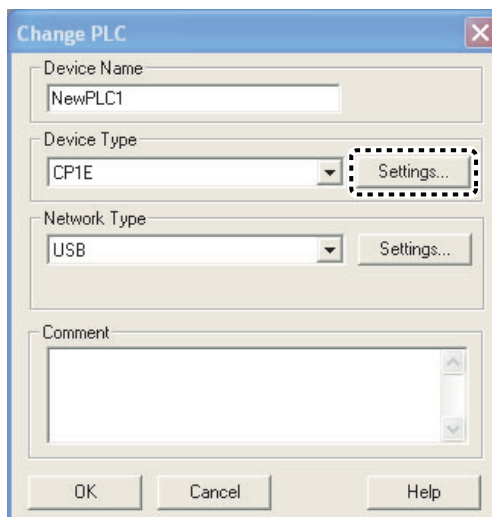

- 4 Select a CPU Unit model in the CPU Type box, and then click the **OK** Button. The PLC Type Settings Dialog Box will close.

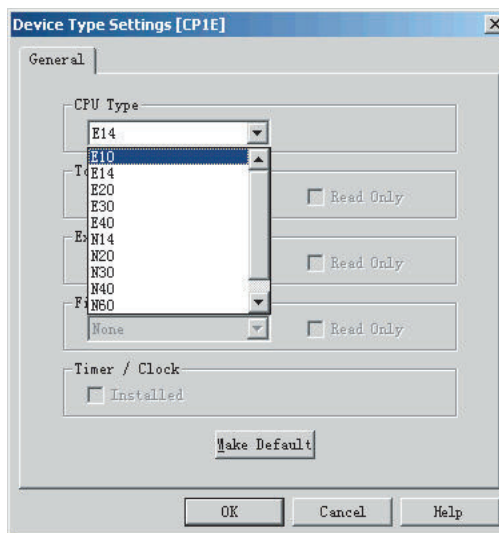

- 5 Confirm that "USB" is displayed as the network type, and then click the **OK** Button.  
The Change PLC Dialog Box will close, and the Main Window will be displayed for a new project.

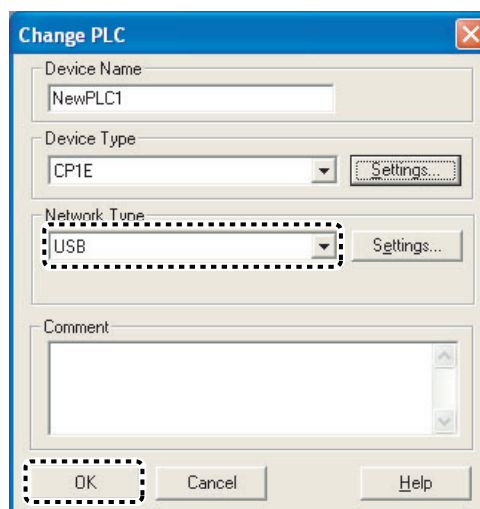

 **Additional Information**

If "USB" is not displayed for the network type, refer to *4-2-2 Installing the USB Driver in the CP1E CPU Unit Hardware User's Manual (Cat.No.W479)*, and check that the USB driver has been installed correctly.

## Entering NO and NC Input Conditions

- For a NO input condition using the LD instruction, press the **L** or **C** Key and select *LD*. For an OR input condition, press the **O** or **W** Key and select *OR*.
- For a NC input condition, press the **L** or **/** Key, and then select *LD NOT*. For an OR NOT input condition, press **O** or **X** and select *OR NOT*.
- Press the **Enter** Key, and then enter the address.

### Inputting a NO Input Condition

**1** Press either the **L** or **C** Key. “LD 0.00” will be displayed.

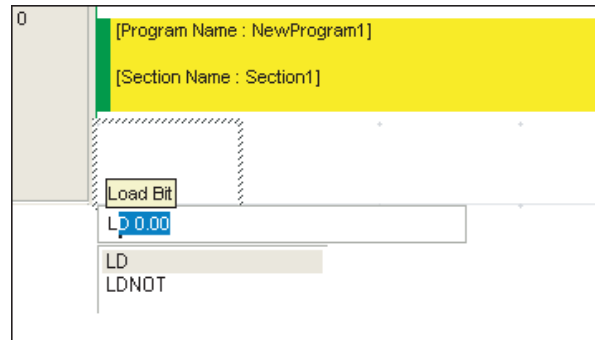

**2** Press the **Enter** Key.  
“Bit (1/1)” will be displayed and “0.00” will be displayed in reverse video.

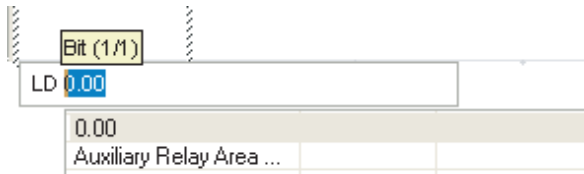

**3** If the address is not CIO 0.00, input the correct address from the keyboard. For example, input “0.02.”

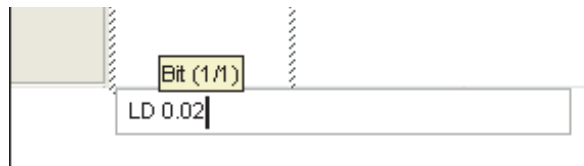

To select an Auxiliary Area bit\*, press the Down Cursor Key to move the cursor to the Auxiliary Area List, press the Enter Key, and then select a bit from the list.

\* Condition Flag or previously registered Auxiliary Area bit.

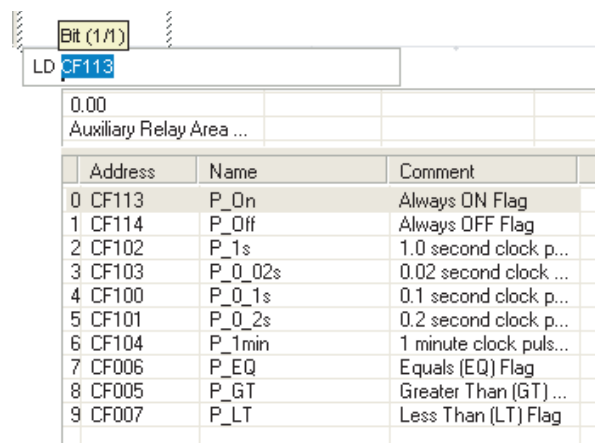

**4** Press the **Enter** Key.  
This completes inputting the LD instruction.

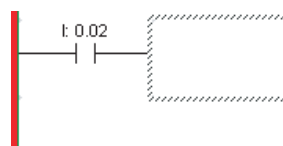



**Additional Information**

- The following instruction variations can be input.
  - Upward differentiation (@)
  - Downward differentiation (%)
  - Immediate refreshing (!)

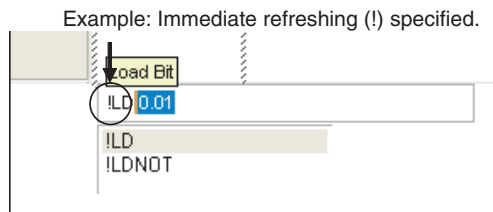

The symbols indicating these instruction variations will be added to the beginning of the instruction whenever they are input regardless of whether the cursor is before (example: |LD), in the middle (example:L|D), or at the end (example: LD|) of the instruction.

- After an instruction has been entered, the variation can be changed as follows.
  - @: Upward differentiation
  - %: Downward differentiation
  - !: Immediate refreshing
  - Shift + 0: No differentiation

**Inputting an OUTPUT Instruction**

- To input an OUTPUT instruction, press the **O** Key and select *OUT*.
- To input an OUTPUT NOT instruction, press the **O** or **Q** Key, and then select *OUT NOT*.
- Press the **Enter** Key, and then enter the address.

**Input Example**

**1** Press the **O** Key.  
 "OUT 100.00" will be displayed.

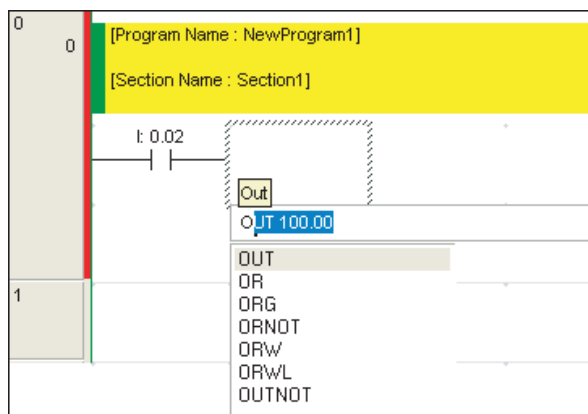

**2** Press the **Enter** Key.  
 An OUTPUT instruction will be displayed with "100.00" in reverse video.

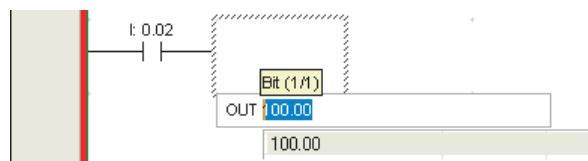

- 3 For an address other than CIO 100.00, input the address from the keyboard. Here, "100.02" has been input.

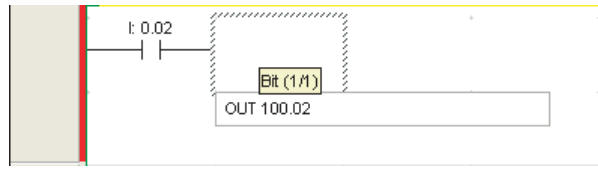

- 4 Press the **Enter** Key.  
This completes inputting the OUTPUT instruction.



## Inputting Instructions

A mnemonic can be entered directly as a character string.

When you enter the first letter, a list of candidate mnemonics will be displayed. Use the **Up Cursor** and **Down Cursor** Keys to move up and down through this list, and then press the **Enter** Key to make a selection. Then, input the operands.

### ● Example: TIM Instruction

- 1 Press the **T** Key.  
A list of instructions beginning with T will be displayed.

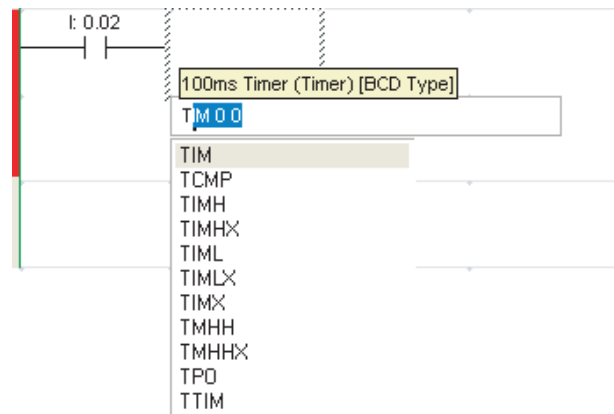

- 2 Press the **Enter** Key.  
"Timer number (1/2)" will be displayed, and "0" will be displayed in reverse video.

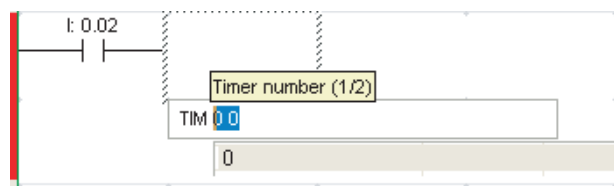

- 3 Input the timer number.  
For example, input "3" and then press the **Enter** Key.

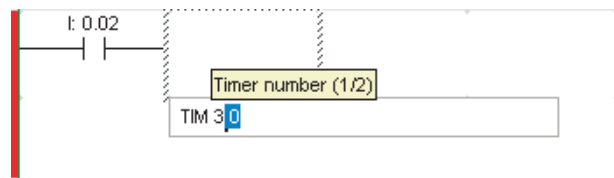

- 4 Input the timer set value.  
For example, input "#10."

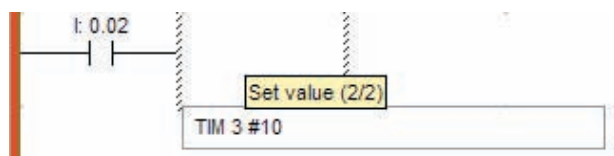

- 5 Press the **Enter** Key.  
This completes inputting the TIM instruction.



## Copying Rungs Using the Automatic Address Increment Function

When rungs are copied and then pasted, it is possible to automatically increment the addresses by the specified number when pasting the rungs.

Example: When the following rung is copied, the bit addresses can be incremented by +16, and the word address can be incremented by +10 when pasting the rung.



- 1 Select the above rung and then select **Address Increment Copy** from the Edit Menu.  
The following dialog box will be displayed.

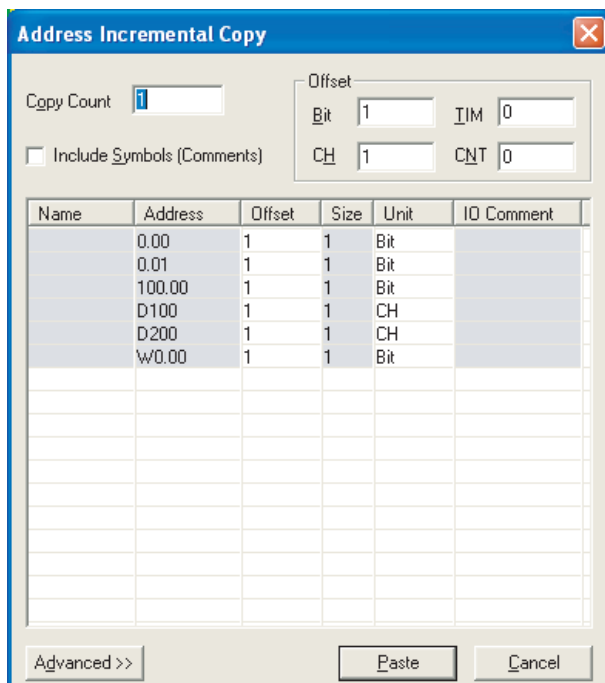

- 2 In the Offset Area set the Bit Field to 16 and the CH Field to 10 for this example.  
Click the **Paste** Button.

As shown below, the addresses are automatically incremented and the rung is pasted as the next rung.

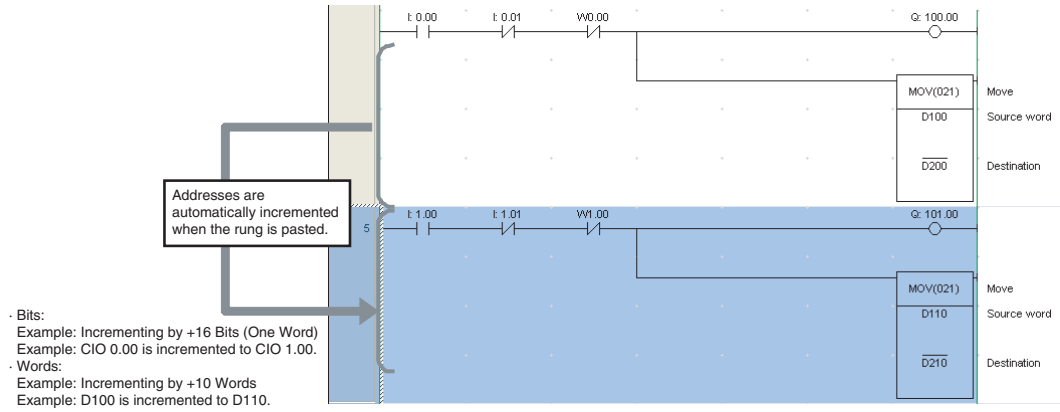

● **Automatic Creation of Symbol Names and I/O Comments**

If there are symbol names or I/O comments in the rung that was copied, executing the *Address Increment Copy* Command will automatically create symbol names and I/O comments.

• Automatic Symbol Name Creation

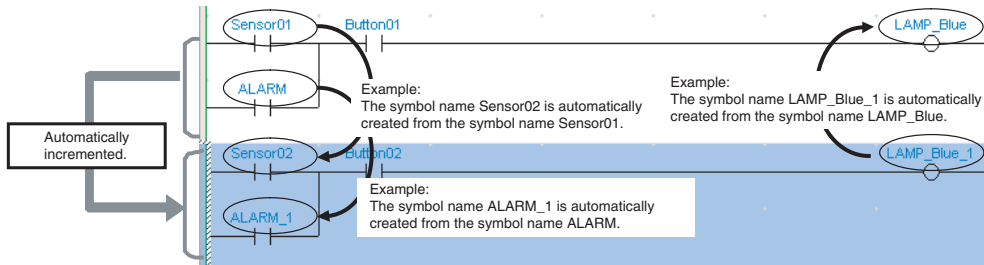

• Automatic I/O Comment Creation

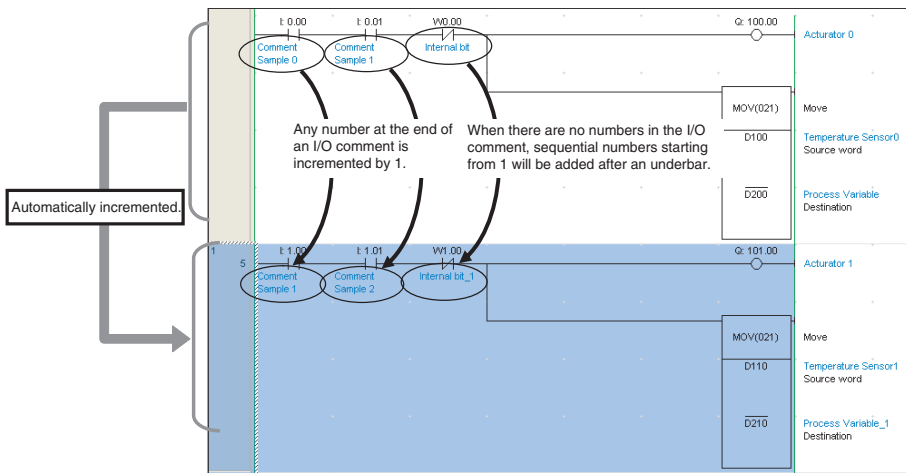

• Automatic Creation Rules

By default, automatic creation is governed by the following rules.

Target	Automatic creation rule	Description
Symbol names	Increment the numbers found from tail.	The symbol name is searched for a number starting from the end, and any number that is found is incremented by 1. If no number is found, an underbar and a sequential number starting from 1 are appended.
I/O comments	Increment the numbers found from tail.	The I/O comment is searched for a number starting from the end, and any number that is found is incremented by 1. If no number is found, an underbar and a sequential number starting from 1 are appended.



Other rules may also be applicable.

Click the **Advanced** Button to select options. The options are enabled when the **Paste** Button is clicked.

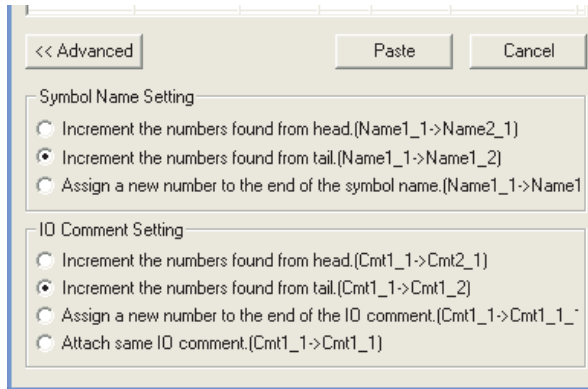

Target	Automatic creation rule	Description
Symbol names	Increment the numbers found from head.	The symbol name is searched for a number starting from the beginning, and any number that is found is incremented by 1. If no number is found, an underbar and a sequential number starting from 1 are appended.
	Assign a new number to the end of the symbol name.	And underbar and sequential number, starting from 1, are appended to the end of the symbol name.
I/O comments	Increment the numbers found from head.	The I/O comment is searched for a number starting from the beginning, and any number that is found is incremented by 1. If no number is found, an underbar and a sequential number starting from 1 are appended.
	Assign a new number to the end of the I/O comment.	An underbar and a sequential number starting from 1 are appended to the end of the I/O comment.
	Attach same I/O comment.	The same I/O comment is used for the copy.

### 19-3-2 Saving and Reading Ladder Programs

Always save the ladder program that you have created. This section describes how to check, save, and read a ladder program.

#### Checking a Ladder Program for Errors

You can check for errors in a program by compiling it.

- 1 Select **Compile All PLC Programs** from the Program Menu.

Compiling will start. Once compiling has been completed, the results of the program check will be displayed in the Output Window.

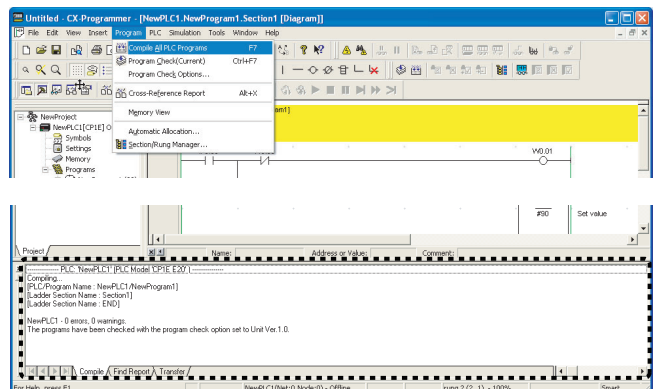

- 2 If an error was found, double-click the error message displayed in the Output Window.

The cursor will move to the location of the error. Correct the ladder program as required.

**Note** When there is more than one error, press the **Shift + J** keys to search for errors in order.

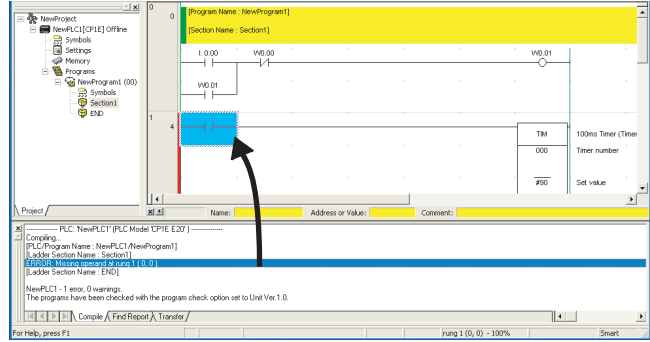

## Saving a Ladder Program

Once created, a ladder program must be saved. Ladder programs are saved in projects.

- 1 Select **Save As** from the File Menu.

The Save CX-Programmer File Dialog Box will be displayed.

- 2 Specify the save location, input the file name, and then click the **Save** Button.

The CX-Programmer project file will be saved.

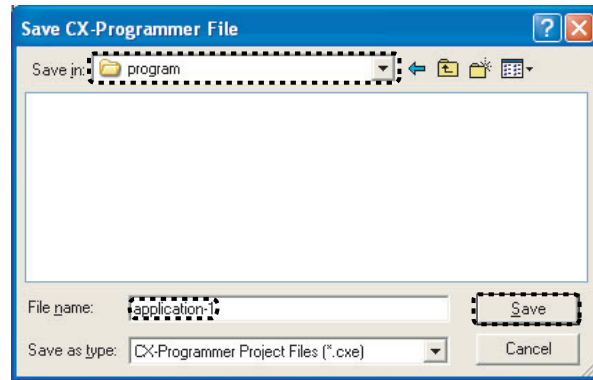
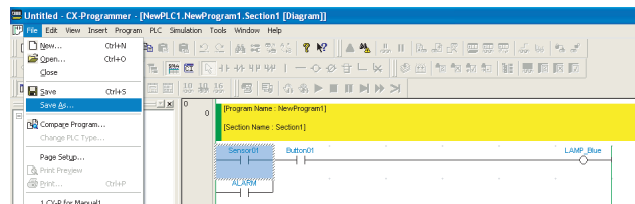

### 19-3-3 Editing Ladder Programs

A ladder program can be edited in the CX-Programmer. Also, I/O comments and rung comments can be input.

## Inputting and Editing I/O Comments

### ● Inputting an I/O Comment with the Ladder Editor

In Smart Input Mode, an I/O comment can be input after an operand has been input using the Comment Dialog Box.

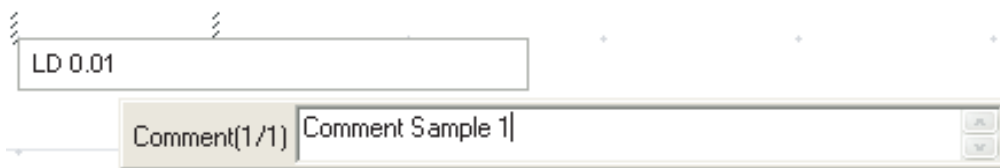

**Note** The Comment Dialog Box shown above is displayed only when the *Show with comment dialog* Option is selected on the Options - Diagrams Dialog Box. The Options - Diagrams Dialog Box is accessed by selecting **Options** from the Tools Menu.

● **Inputting by Editing I/O Comments**

Multiple I/O comments can be input or changed from an address list.

- 1 Select **Edit I/O Comment** from the Edit Menu.

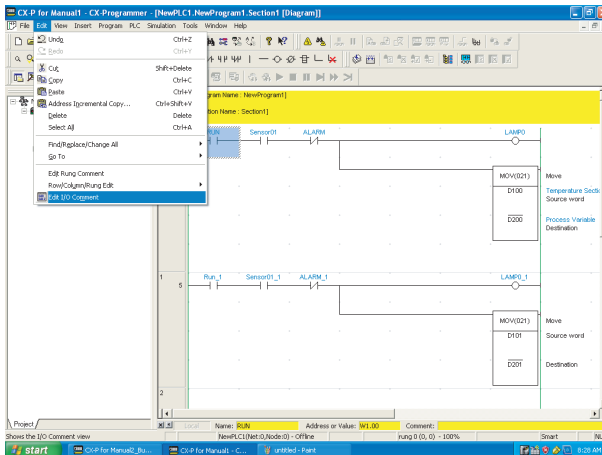

The I/O Comment Editing Window will be displayed.

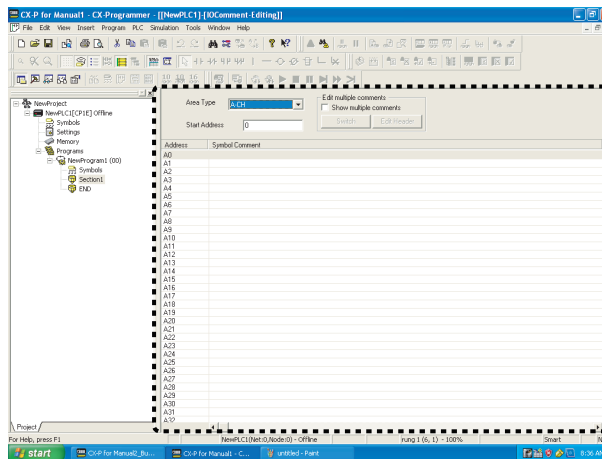

- 2 Input I/O comments or double-click the address for which the I/O comments are to be changed. Inputting the I/O comment will be enabled, so input the I/O comment.

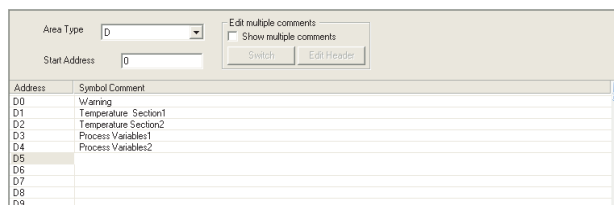

## Inputting Rung Comments

Comments can be added to rungs in the program.

- 1** Double-click the header of the rung to which a comment is to be attached.  
The Rung Properties Dialog Box will be displayed.

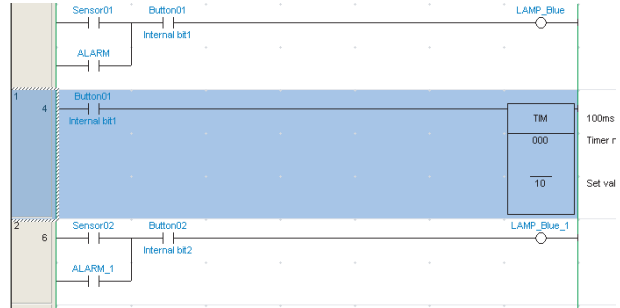

- 2** Input a comment into the Comment Field on the General Tab Page.

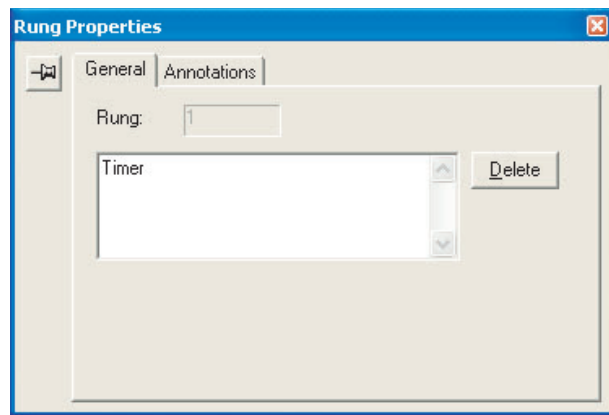

- 3** Close the Rung Properties Dialog Box.  
The input rung comment will be displayed in the ladder program.

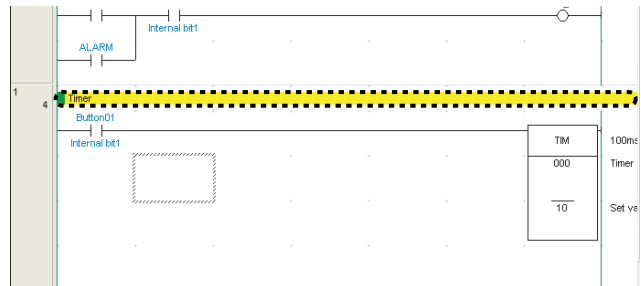

## 19-4 Connecting Online to the CP1E and Transferring the Program

This section describes how to make an online connection between the CX-Programmer and the CP1E, and then transfer a ladder program to the CP1E.

### 19-4-1 Connecting Online

To enable transferring programs from the CX-Programmer to the CP1E, it is first necessary to place the CX-Programmer online with the CP1E.

Online is the state in which communications is possible between the computer and the CP1E.

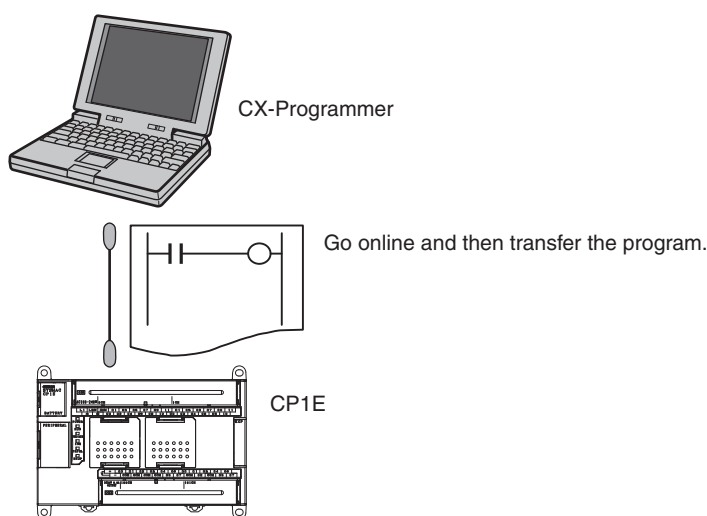

**1** Open the project containing the program to be transferred from the CX-Programmer.

**2** Select **Work Online** from the PLC Menu of the CX-Programmer. A dialog box to confirm going online will be displayed.

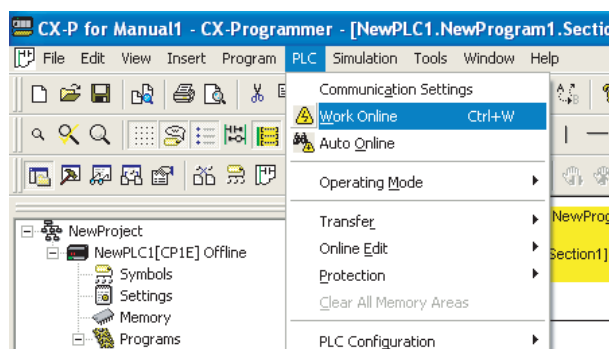

**3** Click the **Yes** Button.

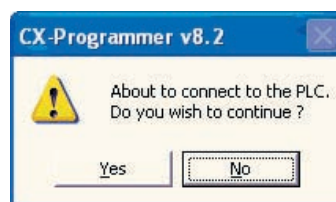

Once the online connection has been established, the color of the Ladder Section Window will change to light gray.

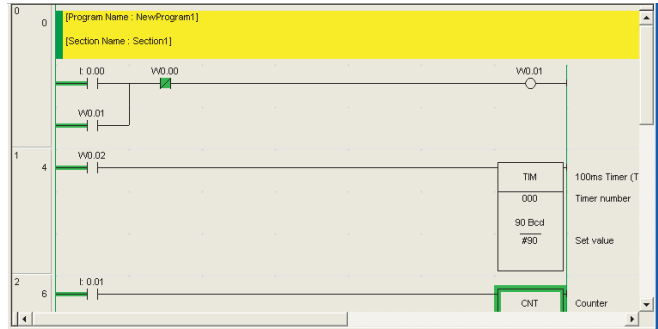

**Additional Information**

If it is not possible to establish an online connection, check the PLC type setting and the communications settings. To check them, double-click *New PLC1 [CP1E] Offline* in the project tree. For details on these settings, refer to *Creating a New Project in 19-3-1 Inputting a Ladder Program*.

**19-4-2 Changing Operating Modes**

The operating mode can be changed to PROGRAM mode.

The procedure for changing to PROGRAM mode is given below.

- 1 Select **Operating Mode - Program** from the PLC Menu.

A dialog box to confirm changing the operating mode will be displayed.

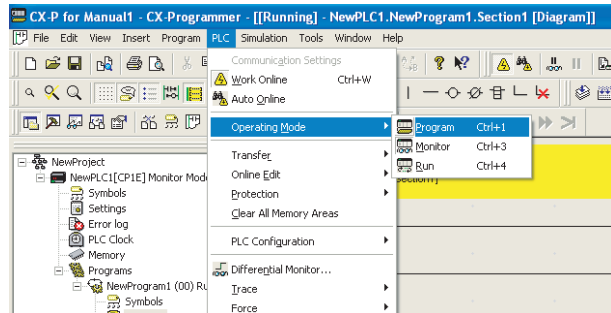

- 2 Click the **Yes** Button.

The operating mode will be changed.

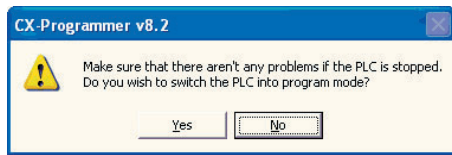

The operating mode is displayed in the project tree.

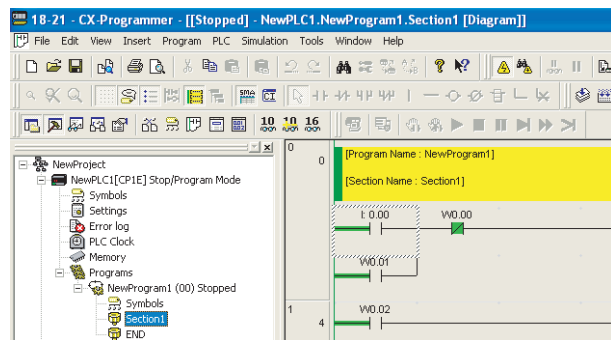

**Additional Information**

Change to PROGRAM mode before transferring the PLC Setup and ladder program.

### 19-4-3 Transferring a Ladder Program and the PLC Setup

A ladder program created with the CX-Programmer can be transferred to the CP1E.

- 1 Change to PROGRAM mode, select **Operating Mode - Program** from the PLC Menu, and then click the **Yes** Button.
- 2 Select **Transfer - Transfer [PC→PLC]** from the PLC Menu. The Download Options Dialog Box will be displayed.

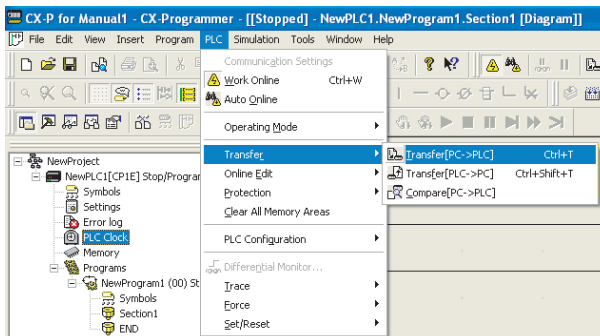

- 3 Click the **OK** Button.  
A dialog box to confirm the transfer will be displayed.  
To transfer the PLC Setup, select the Settings Check Box.

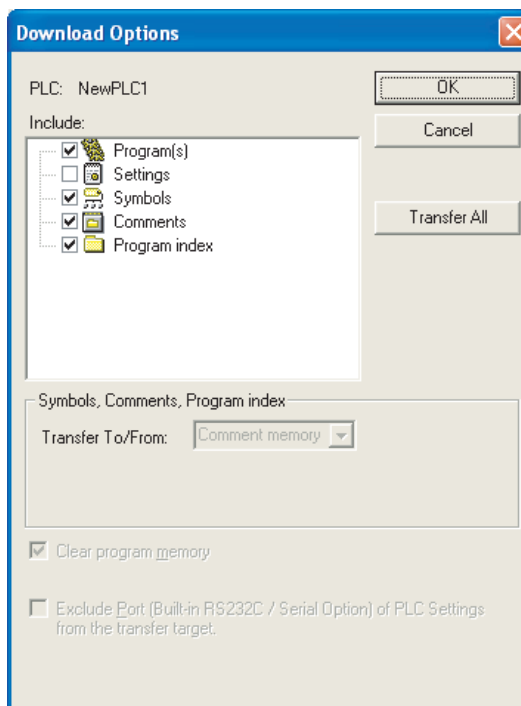

#### Additional Information

For details on the transfer options, refer to the CX-Programmer Online Help.

- 4** Click the **Yes** Button.

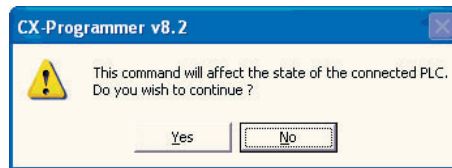

- 5** Click the **OK** Button.  
This completes transferring the ladder program.

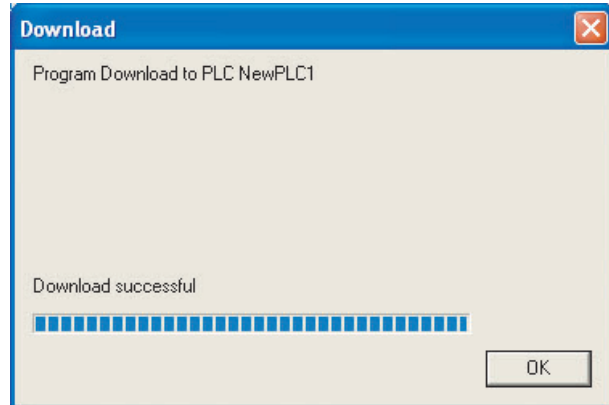

#### 19-4-4 Starting Operation

To start operation, turn ON the power or change the operating mode to RUN mode.



##### **Precautions for Correct Use**

Operation will not be started when the power is turned ON if the PLC Setup is set so that the PLC enters PROGRAM mode at startup.

Use the following procedure to change the operating mode to RUN mode. To perform trial operation for debugging or adjustments, change the operating mode to MONITOR mode.



##### **Precautions for Safe Use**

Always confirm the safety of the controlled system before changing to MONITOR or RUN mode.



- 1 Select **Operating Mode - Run** from the PLC Menu.

A dialog box to confirm changing the operating mode will be displayed.

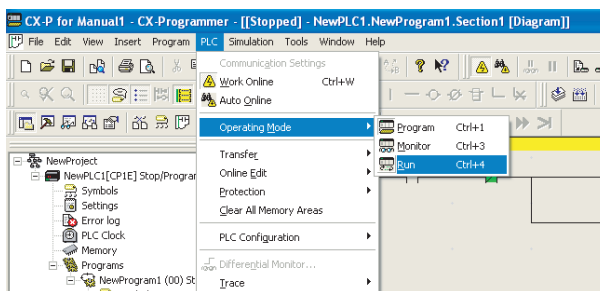

- 2 Click the **Yes** Button.

The CP1E will change to RUN mode, and operation will start.

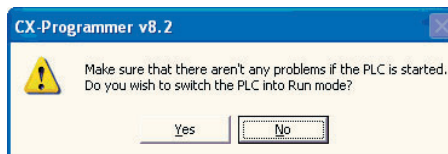

**Additional Information**

PROGRAM mode cannot be changed to MONITOR or RUN mode when the user program, PLC Setup settings and DM area data in the CPU Units are being backed up. Change the operating mode after the backup is completed.

## 19-5 Online Monitoring and Debugging

This section describes how to use CX-Programmer to monitor and debug a ladder program.

### 19-5-1 Monitoring Status

#### Displaying Execution Status

It is possible to display the execution status of a ladder program. This enables checking the execution of the ladder program.

Change the CP1E's operating mode to MONITOR mode to display the execution status.

The execution status of the ladder program will be displayed.

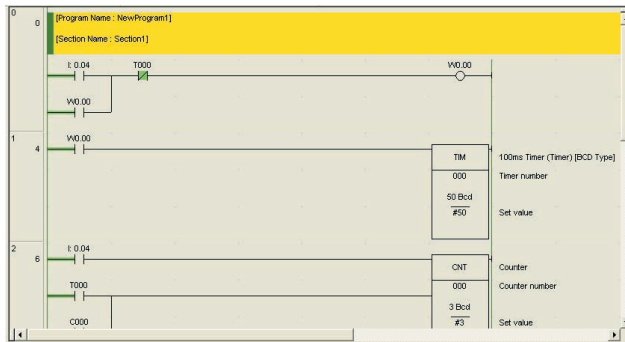

#### Displaying the Execution Status for More than One Location

The Ladder Section Window can be split. This enables displaying multiple locations within a ladder program so that you can check them at the same time.

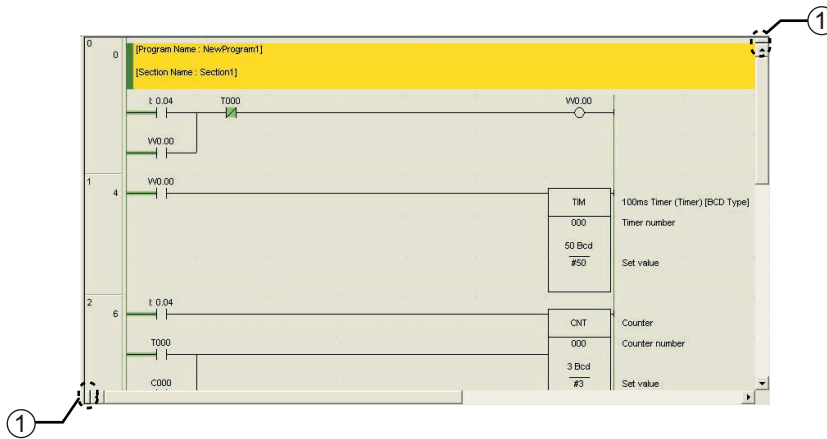

● **Window Frames**

You can drag the frames in the window to display different views of the program in the Ladder Section Window. The window can be split into up to four sections.

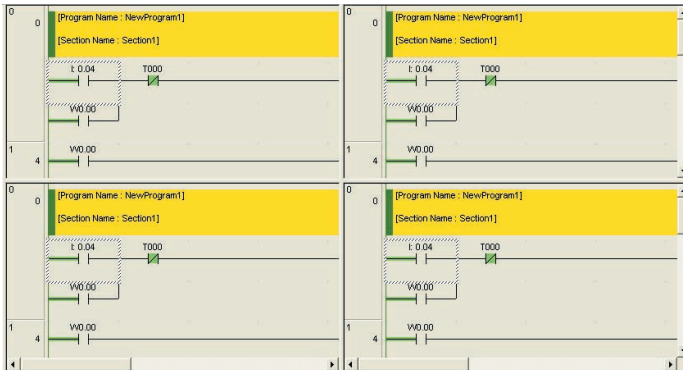

**Monitoring Specified Addresses**

You can specify addresses to check bit status and word contents.

**1** While online, select **Window - Watch Window** from the View Menu.

**2** Input an address.

The bit status or word contents will be displayed. For BOOL data, 0 indicates OFF.

PLC Name	Name	Address	Data T...	FB Usage	Value	Value(B...	Comment
NewPLC1		0.04	BOOL (...		0		
NewPLC1		0.05	BOOL (...		0		
		T000					



**Additional Information**

- When entering an address, place a period between the word address and bit number. For example, to input the address of bit 04 in CIO 0, input “0.04.”
- An address can be input by dragging it from the Ladder Section Window and dropping it into the Watch Window. By dragging and dropping the header of a rung, all of the addresses on that rung can be input.

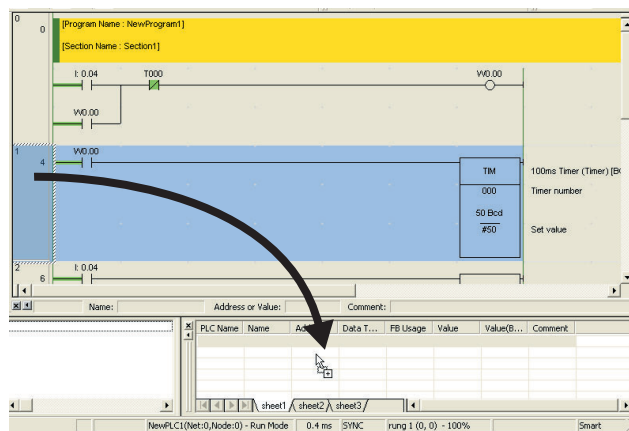

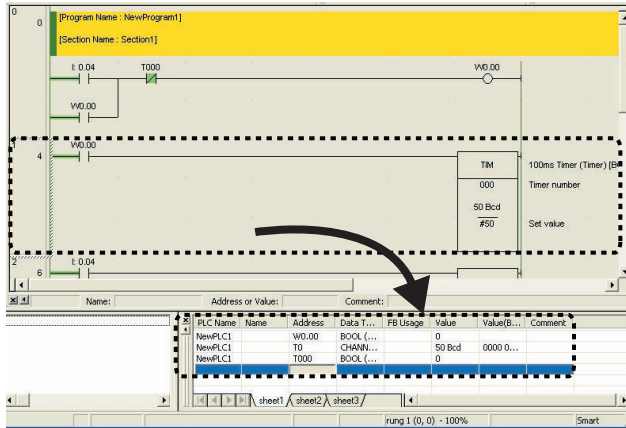

### 19-5-2 Force-set/Reset Bits

Input bits can be controlled from CX-Programmer regardless of input status from the input devices. This is used to establish input and output conditions when performing trial operation, or to see the effect of establishing conditions when debugging.

#### Bits that can be Force-set/Reset

- I/O bits
- Word Area bits (W)
- Timer Completion Flags
- Holding Area Bits (H)
- Counter Completion Flags



#### Precautions for Safe Use

Always check the safety of the system before force-setting or force-resetting a bit and before releasing forced status.

#### Force-setting

Force-setting a bit.

- 1** Set the CP1E operating mode to either MONITOR or PROGRAM mode.
- 2** Move the cursor to an input condition for the input bit that is to be force-set.

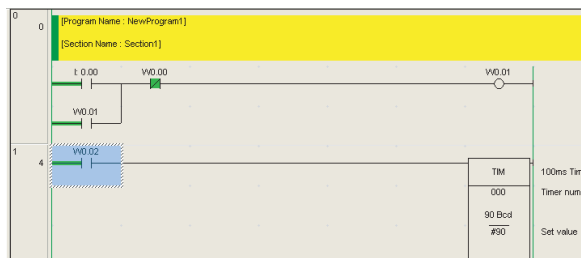

### 3 Right-click and select **Force - On**.

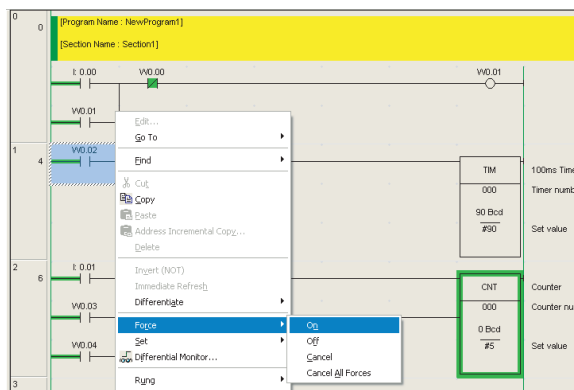

The input bit will be force-set. A symbol indicating the force-set status will be displayed at the input condition.

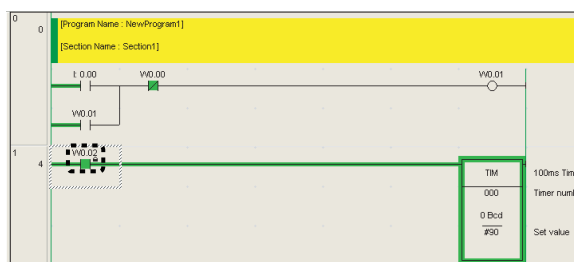

#### Additional Information

- Select **On** to turn ON a bit and **Off** to turn OFF a bit.
- To cancel forced status, select **Cancel**.

## 19-5-3 Online Editing

### About Online Editing

A ladder program running on the CP1E can be edited online.

This can be done while the CP1E is in MONITOR mode or PROGRAM mode.

Using the CX-Programmer, it is possible to either change part of a ladder program running on the CP1E, or make an addition to the program.

Online editing is used to make minor changes to the ladder program without actually stopping the operation of the CP1E.



#### Precautions for Correct Use

- When a ladder program has been changed using online editing, the cycle time may increase by one or more cycles, or it may not be possible to read an input signal.
- Major changes, such as moving a rung, copying, inserting, or deleting, should be done offline and then the program should be transferred to the CP1E again.
- After completing online editing, the results of editing are backed up to backup memory, resulting in a longer cycle time. While this is being done, the BKUP indicator will be lit, and the CX-Programmer will indicate the progress.
- An increase of one cycle will be 16ms maximum during online editing and 8% of cycle time during back up.
- Do not turn OFF the power supply to the CPU Unit after online editing, until the backup to the backup memory is completed (the BKUP indicator is OFF).

## Online Editing Procedure

- 1** Change the CP1E's operating mode to MONITOR or PROGRAM mode.
- 2** Click the header of the rung to be edited.
- 3** Select **Online Edit - Begin** from the PLC Menu.  
The gray color will be cleared from the Ladder Section Window to indicate that the ladder program can be edited.

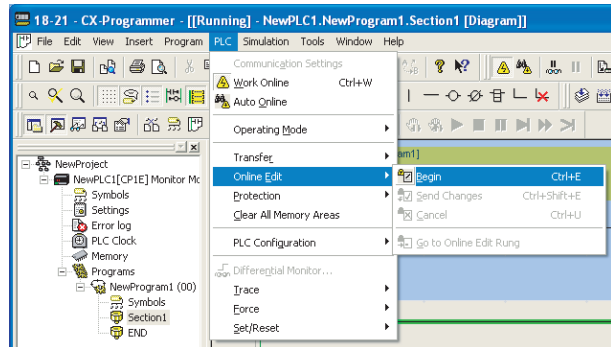

- 4** Edit the ladder program.

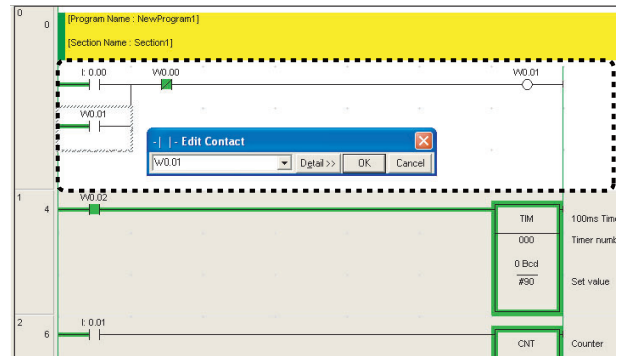

- 5** Select **Online Edit - Send Changes** from the PLC Menu.  
The edited rung will be transferred to the CP1E.

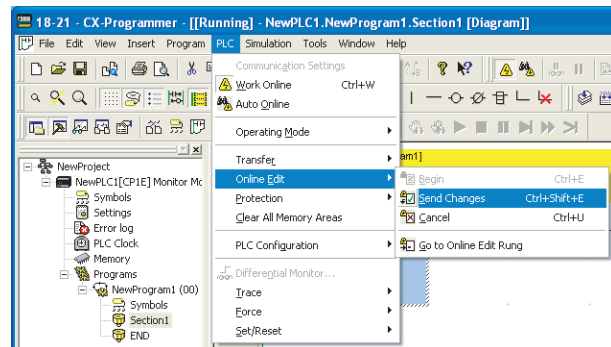

# App

## Appendices





<b>A-1</b>	<b>Instruction Functions</b>	<b>A-2</b>
A-1-1	Sequence Input Instructions	A-2
A-1-2	Sequence Output Instructions	A-3
A-1-3	Sequence Control Instructions	A-5
A-1-4	Timer and Counter Instructions	A-7
A-1-5	Comparison Instructions	A-10
A-1-6	Data Movement Instructions	A-12
A-1-7	Data Shift Instructions	A-15
A-1-8	Increment/Decrement Instructions	A-17
A-1-9	Symbol Math Instructions	A-18
A-1-10	Conversion Instructions	A-22
A-1-11	Logic Instructions	A-26
A-1-12	Special Math Instructions	A-27
A-1-13	Floating-point Math Instructions	A-27
A-1-14	Table Data Processing Instructions	A-30
A-1-15	Data Control Instructions	A-31
A-1-16	Subroutine Instructions	A-35
A-1-17	Interrupt Control Instructions	A-36
A-1-18	High-speed Counter/Pulse Output Instructions	A-37
A-1-19	Step Instructions	A-44
A-1-20	Basic I/O Unit Instructions	A-45
A-1-21	Serial Communications Instructions	A-49
A-1-22	Clock Instructions	A-50
A-1-23	Failure Diagnosis Instructions	A-51
A-1-24	Other Instructions	A-51
<b>A-2</b>	<b>Auxiliary Area Allocations by Address</b>	<b>A-52</b>
A-2-1	Read-only Words	A-52
A-2-2	Read/Write Words	A-70
<b>A-3</b>	<b>Response Performance</b>	<b>A-80</b>
A-3-1	I/O Response Time	A-80
A-3-2	Interrupt Response Time	A-82
A-3-3	Serial PLC Link Response Performance	A-83
A-3-4	Pulse Output Start Time	A-84
A-3-5	Pulse Output Change Response Time	A-84
<b>A-4</b>	<b>PLC Operation for Power Interruptions</b>	<b>A-85</b>

# A-1 Instruction Functions

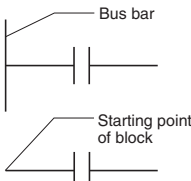
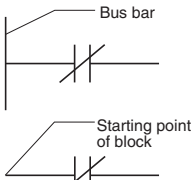
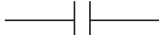

The CP1E CPU Units support the following instructions.

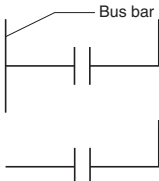
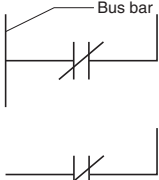
Refer to the *CP1E CPU Unit Instructions Reference Manual* (Cat. No. W483) for details.





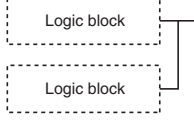
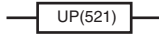

## A-1-1 Sequence Input Instructions

Instruction	Mnemonic	Variations	Symbol/Operand	Function
LOAD	LD	@I%/I!@I%		Indicates a logical start and creates an ON/OFF execution condition based on the ON/OFF status of the specified operand bit.
LOAD NOT	LD NOT	@I%/I!@I%		Indicates a logical start and creates an ON/OFF execution condition based on the reverse of the ON/OFF status of the specified operand bit.
AND	AND	@I%/I!@I%	Symbol 	Takes a logical AND of the status of the specified operand bit and the current execution condition.
AND NOT	AND NOT	@I%/I!@I%	Symbol 	Reverses the status of the specified operand bit and takes a logical AND with the current execution condition.
OR	OR	@I%/I!@I%		Takes a logical OR of the ON/OFF status of the specified operand bit and the current execution condition.
OR NOT	OR NOT	@I%/I!@I%		Reverses the status of the specified bit and takes a logical OR with the current execution condition.
AND LOAD	AND LD	---		<p>Takes a logical AND between logic blocks.</p> <p>LD to } Logic block A</p> <p>LD to } Logic block B</p> <p>AND LD ..... Serial connection between logic block A and logic block B.</p>

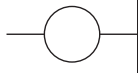
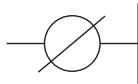
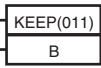
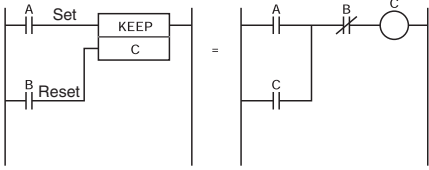
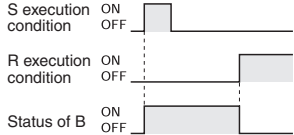

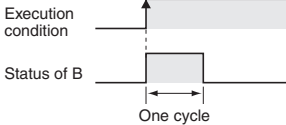
Instruction	Mnemonic	Variations	Symbol/Operand	Function
OR LOAD	OR LD	---		<p>Takes a logical OR between logic blocks.</p> <p>LD to } Logic block A</p> <p>LD to } Logic block B</p> <p>OR LD ..... Parallel connection between logic block A and logic block B.</p>
NOT	NOT	---		Reverses the execution condition.
CONDITION ON	UP	---		UP(521) turns ON the execution condition for one cycle when the execution condition goes from OFF to ON.
CONDITION OFF	DOWN	---		DOWN(522) turns ON the execution condition for one cycle when the execution condition goes from ON to OFF.

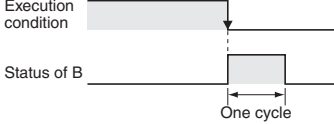

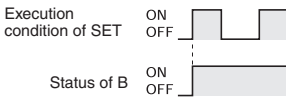

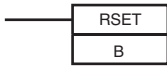
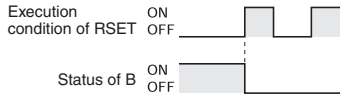
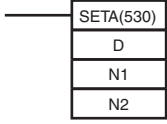
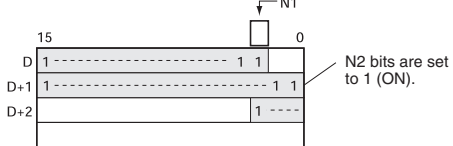
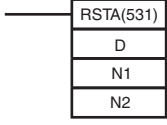
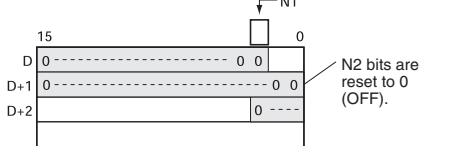
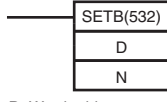
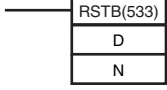
## A-1-2 Sequence Output Instructions

Instruction	Mnemonic	Variations	Symbol/Operand	Function
OUTPUT	OUT	!		Outputs the result (execution condition) of the logical processing to the specified bit.
OUTPUT NOT	OUT NOT	!		Reverses the result (execution condition) of the logical processing, and outputs it to the specified bit.
KEEP	KEEP	!	<p>S (Set) </p> <p>R (Reset)</p> <p>B: Bit</p>	<p>Operates as a latching relay.</p>  
DIFFERENTIATE UP	DIFU	!	 <p>B: Bit</p>	<p>DIFU(013) turns the designated bit ON for one cycle when the execution condition goes from OFF to ON (rising edge).</p> 
DIFFERENTIATE DOWN	DIFD	!	 <p>B: Bit</p>	<p>DIFD(014) turns the designated bit ON for one cycle when the execution condition goes from ON to OFF (falling edge).</p> 
SET	SET	@!%/!/@!/%	 <p>B: Bit</p>	<p>SET turns the operand bit ON when the execution condition is ON.</p> 



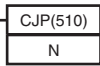
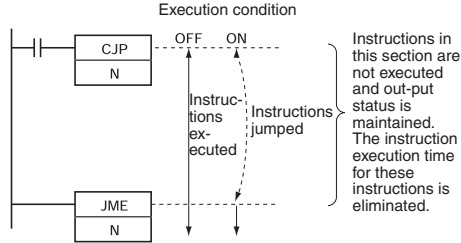
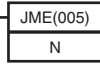
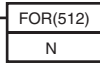
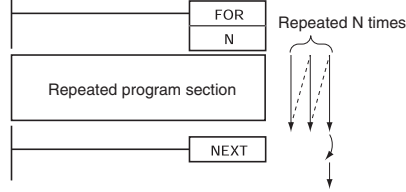

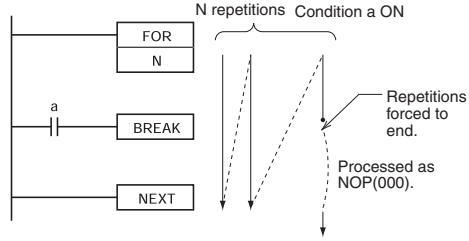



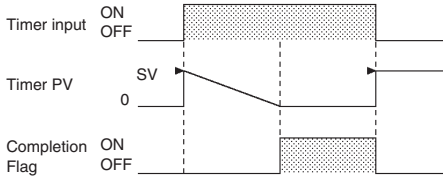

Instruction	Mnemonic	Variations	Symbol/Operand	Function
RESET	RSET	@/!/!@/!%	 <p>B: Bit</p>	<p>RSET turns the operand bit OFF when the execution condition is ON.</p> 
MULTIPLE BIT SET	SETA	@	 <p>D: Beginning word N1: Beginning bit N2: Number of bits</p>	<p>SETA(530) turns ON the specified number of consecutive bits.</p> 
MULTIPLE BIT RESET	RSTA	@	 <p>D: Beginning word N1: Beginning bit N2: Number of bits</p>	<p>RSTA(531) turns OFF the specified number of consecutive bits.</p> 
SINGLE BIT SET	SETB	@/!/!	 <p>D: Word address N: Bit number</p>	<p>SETB(532) turns ON the specified bit in the specified word when the execution condition is ON.</p> <p>Unlike the SET instruction, SETB(532) can be used to reset a bit in a DM word.</p>
SINGLE BIT RESET	RSTB	@/!/!	 <p>D: Word address N: Bit number</p>	<p>RSTB(533) turns OFF the specified bit in the specified word when the execution condition is ON.</p> <p>Unlike the RSET instruction, RSTB(533) can be used to reset a bit in a DM word.</p>

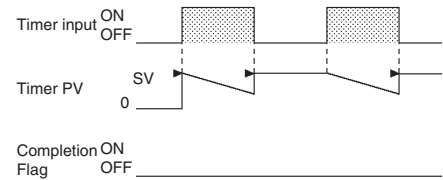
### A-1-3 Sequence Control Instructions

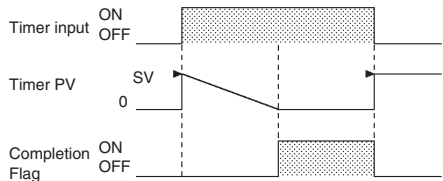
Instruction	Mnemonic	Variations	Symbol/Operand	Function
END	END	---		Indicates the end of a program.
NO OPERATION	NOP	---	---	This instruction has no function. (No processing is performed for NOP(000).)
INTERLOCK	IL	---		<p>Interlocks all outputs between IL(002) and ILC(003) when the execution condition for IL(002) is OFF. IL(002) and ILC(003) are normally used in pairs.</p>
INTERLOCK CLEAR	ILC	---		All outputs between IL(002) and ILC(003) are interlocked when the execution condition for IL(002) is OFF. IL(002) and ILC(003) are normally used in pairs.
MULTI-INTERLOCK DIFFERENTIATION HOLD	MILH	---	 N: Interlock number D: Interlock Status Bit	<p>When the execution condition for MILH(517) is OFF, the outputs for all instructions between that MILH(517) instruction and the next MILC(519) instruction are interlocked. MILH(517) and MILC(519) are used as a pair.</p> <p>MILH(517)/MILC(519) interlocks can be nested (e.g., MILH(517)-MILH(517)-MILC(519)-MILC(519)).</p> <p>If there is a differentiated instruction (DIFU, DIFD, or instruction with a @ or % prefix) between MILH(517) and the corresponding MILC(519), that instruction will be executed after the interlock is cleared if the differentiation condition of the instruction was established.</p>
MULTI-INTERLOCK DIFFERENTIATION RELEASE	MILR	---	 N: Interlock number D: Interlock Status Bit	<p>When the execution condition for MILR(518) is OFF, the outputs for all instructions between that MILR(518) instruction and the next MILC(519) instruction are interlocked. MILR(518) and MILC(519) are used as a pair.</p> <p>MILR(518)/MILC(519) interlocks can be nested (e.g., MILR(518)-MILR(518)-MILC(519)-MILC(519)).</p> <p>If there is a differentiated instruction (DIFU, DIFD, or instruction with a @ or % prefix) between MILR(518) and the corresponding MILC(519), that instruction will not be executed after the interlock is cleared even if the differentiation condition of the instruction was established.</p>
MULTI-INTERLOCK CLEAR	MILC	---	 N: Interlock number	<p>Clears an interlock started by an MILH(517) or MILR(518) with the same interlock number.</p> <p>All outputs between MILH(517)/MILR(518) and the corresponding MILC(519) with the same interlock number are interlocked when the execution condition for MILH(517)/MILR(518) is OFF.</p>
JUMP	JMP	---	 N: Interlock number	<p>When the execution condition for JMP(004) is OFF, program execution jumps directly to the first JME(005) in the program with the same jump number. JMP(004) and JME(005) are used in pairs.</p> <p>Instructions in this section are not executed and output status is maintained. The instruction execution time for these instructions is eliminated.</p>

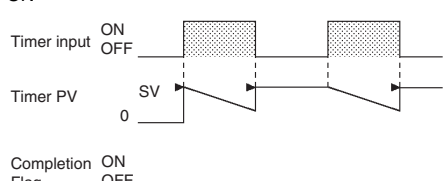
Instruction	Mnemonic	Variations	Symbol/Operand	Function
CONDITIONAL JUMP	CJP	---	 <p>N: Interlock number</p>	<p>The operation of CJP(510) is basically the opposite of JMP(004). When the execution condition for CJP(510) is ON, program execution jumps directly to the first JME(005) in the program with the same jump number. CJP(510) and JME(005) are used in pairs.</p> 
JUMP END	JME	---	 <p>N: Interlock number</p>	Indicates the destination of a jump instruction.
FOR-NEXT LOOPS	FOR	---	 <p>N: Number of loops</p>	<p>The instructions between FOR(512) and NEXT(513) are repeated a specified number of times. FOR(512) and NEXT(513) are used in pairs.</p> 
BREAK LOOP	BREAK	---		<p>Programmed in a FOR-NEXT loop to cancel the execution of the loop for a given execution condition. The remaining instructions in the loop are processed as NOP(000) instructions.</p> 
FOR-NEXT LOOPS	NEXT	---		The instructions between FOR(512) and NEXT(513) are repeated a specified number of times. FOR(512) and NEXT(513) are used in pairs.

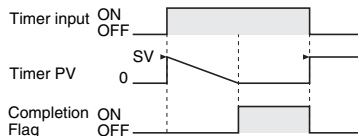
## A-1-4 Timer and Counter Instructions

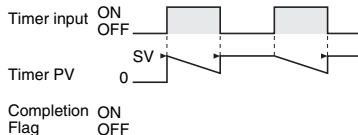
Instruction	Mnemonic	Variations	Symbol/Operand	Function
HUNDRED-MS TIMER	TIM (BCD)	---	 <p>N: Timer number S: Set value</p>	<p>TIM/TIMX(550) operates a decrementing timer with units of 0.1-s. The setting range for the set value (SV) is 0 to 999.9 s for TIM(BCD) and 0 to 6,553.5 s for TIMX(Binary).</p>  <p>Timer input ON OFF</p> <p>Timer PV SV 0</p> <p>Completion Flag ON OFF</p>
	TIMX (Binary)	---	 <p>N: Timer number S: Set value</p>	<p><b>Timer Input Turned OFF before Completion Flag Turns ON</b></p>  <p>Timer input ON OFF</p> <p>Timer PV SV 0</p> <p>Completion ON OFF Flag OFF</p>
TEN-MS TIMER	TIMH (BCD)	---	 <p>N: Timer number S: Set value</p>	<p>TIMH(015)/TIMHX(551) operates a decrementing timer with units of 10-ms. The setting range for the set value (SV) is 0 to 99.99 s for TIMH(BCD) and 0 to 655.35 s for TIMHX(Binary).</p>  <p>Timer input ON OFF</p> <p>Timer PV SV 0</p> <p>Completion ON OFF Flag OFF</p>
	TIMHX (Binary)	---	 <p>N: Timer number S: Set value</p>	<p><b>Timer Input Turned OFF before Completion Flag Turns ON</b></p>  <p>Timer input ON OFF</p> <p>Timer PV SV 0</p> <p>Completion ON OFF Flag OFF</p>
ONE-MS TIMER	TMHH (BCD)	---	 <p>N: Timer number S: Set value</p>	<p>TMHH(540)/TMHXX(552) operates a decrementing timer with units of 1-ms. The setting range for the set value (SV) is 0 to 9.999 s for TMHH(BCD) and 0 to 65.535 s for TMHXX(Binary).</p> <p>The timing charts for TMHH(540) and TMHXX(552) are the same as those given above for TIMH(015).</p>  <p>Timer input ON OFF</p> <p>Timer PV SV 0</p> <p>Completion ON OFF Flag OFF</p>
	TMHXX (BCD)	---	 <p>N: Timer number S: Set value</p>	<p><b>Timer Input Turned OFF before Completion Flag Turns ON</b></p>  <p>Timer input ON OFF</p> <p>Timer PV SV 0</p> <p>Completion ON OFF Flag OFF</p>

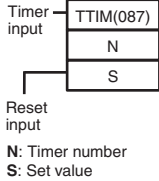
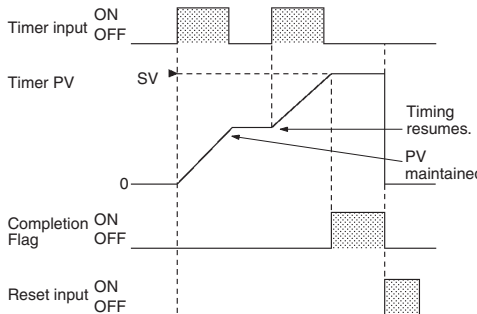
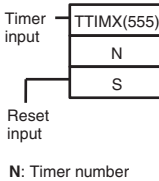
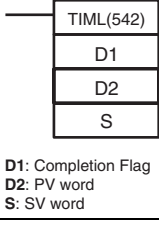
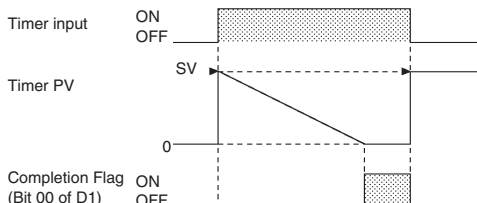
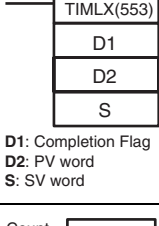
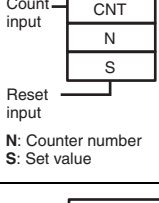
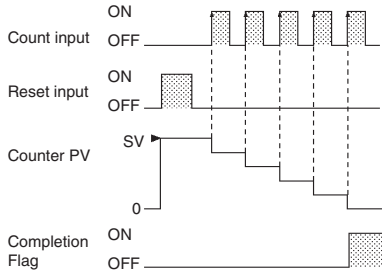
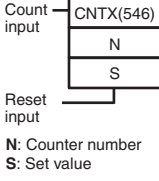
Instruction	Mnemonic	Variations	Symbol/Operand	Function
ACCUMULATIVE TIMER	TTIM (BCD)	---	 <p>Timer input</p> <p>Reset input</p> <p><b>N:</b> Timer number <b>S:</b> Set value</p>	<p>TTIM(087)/TTIMX(555) operates an incrementing timer with units of 0.1-s. The setting range for the set value (SV) is 0 to 999.9 s for TTIM(BCD) and 0 to 6,553.5 s for TTIMX(Binary).</p>  <p>Timer input ON OFF</p> <p>Timer PV SV 0</p> <p>Completion Flag ON OFF</p> <p>Reset input ON OFF</p> <p>Timing resumes. PV maintained.</p>
	TTIMX (Binary)	---	 <p>Timer input</p> <p>Reset input</p> <p><b>N:</b> Timer number <b>S:</b> Set value</p>	
LONG TIMER	TIML (BCD)	---	 <p><b>D1:</b> Completion Flag <b>D2:</b> PV word <b>S:</b> SV word</p>	<p>TIML(542)/TIMLX(553) operates a decremting timer with units of 0.1-s that can time up to approx. 115 days for TIML(BCD) and 49,710 days for TIMLX(Binary).</p>  <p>Timer input ON OFF</p> <p>Timer PV SV 0</p> <p>Completion Flag ON OFF (Bit 00 of D1)</p>
	TIMLX (Binary)	---	 <p><b>D1:</b> Completion Flag <b>D2:</b> PV word <b>S:</b> SV word</p>	
COUNTER	CNT (BCD)	---	 <p>Count input</p> <p>Reset input</p> <p><b>N:</b> Counter number <b>S:</b> Set value</p>	<p>CNT/CNTX(546) operates a decremting counter. The setting range for the set value (SV) is 0 to 9,999 for CNT(BCD) and 0 to 65,535 for CNTX(Binary).</p>  <p>Count input ON OFF</p> <p>Reset input ON OFF</p> <p>Counter PV SV 0</p> <p>Completion Flag ON OFF</p>
	CNTX (Binary)	---	 <p>Count input</p> <p>Reset input</p> <p><b>N:</b> Counter number <b>S:</b> Set value</p>	

Instruction	Mnemonic	Variations	Symbol/Operand	Function
REVERSIBLE COUNTER	CNTR (BCD)	---	<div style="display: flex; align-items: center;"> <div style="margin-right: 5px;">Increment input</div> <div style="border: 1px solid black; padding: 2px;">CNTR(012)</div> </div> <div style="display: flex; align-items: center; margin-top: 5px;"> <div style="margin-right: 5px;">Decrement input</div> <div style="border: 1px solid black; padding: 2px;">N</div> </div> <div style="display: flex; align-items: center; margin-top: 5px;"> <div style="margin-right: 5px;">Reset input</div> <div style="border: 1px solid black; padding: 2px;">S</div> </div> <p style="margin-top: 10px;">N: Counter number S: Set value</p>	<p>CNTR(012)/CNTRX(548) operates a reversible counter.</p>
	CNTRX (Binary)	---	<div style="display: flex; align-items: center;"> <div style="margin-right: 5px;">Increment input</div> <div style="border: 1px solid black; padding: 2px;">CNTRX(548)</div> </div> <div style="display: flex; align-items: center; margin-top: 5px;"> <div style="margin-right: 5px;">Decrement input</div> <div style="border: 1px solid black; padding: 2px;">N</div> </div> <div style="display: flex; align-items: center; margin-top: 5px;"> <div style="margin-right: 5px;">Reset input</div> <div style="border: 1px solid black; padding: 2px;">S</div> </div> <p style="margin-top: 10px;">N: Counter number S: Set value</p>	
RESET TIMER/ COUNTER	CNR (BCD)	@	<div style="border: 1px solid black; padding: 5px; margin-bottom: 5px;"> <div style="border-bottom: 1px solid black; padding-bottom: 2px;">CNR(545)</div> <div style="border-bottom: 1px solid black; padding: 2px;">N1</div> <div style="padding: 2px;">N2</div> </div> <p>N1: 1st number in range N2: Last number in range</p>	<p>CNR(545)/CNRX(547) resets the timers or counters within the specified range of timer or counter numbers. Sets the set value (SV) to the maximum of #9999 for CNR(BCD) and #FFFF for CNRX(Binary).</p>
	CNRX (Binary)	@	<div style="border: 1px solid black; padding: 5px; margin-bottom: 5px;"> <div style="border-bottom: 1px solid black; padding-bottom: 2px;">CNRX(547)</div> <div style="border-bottom: 1px solid black; padding: 2px;">N1</div> <div style="padding: 2px;">N2</div> </div> <p>N1: 1st number in range N2: Last number in range</p>	

## A-1-5 Comparison Instructions

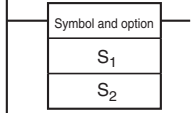
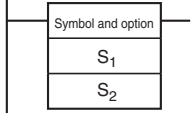
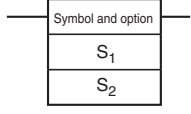
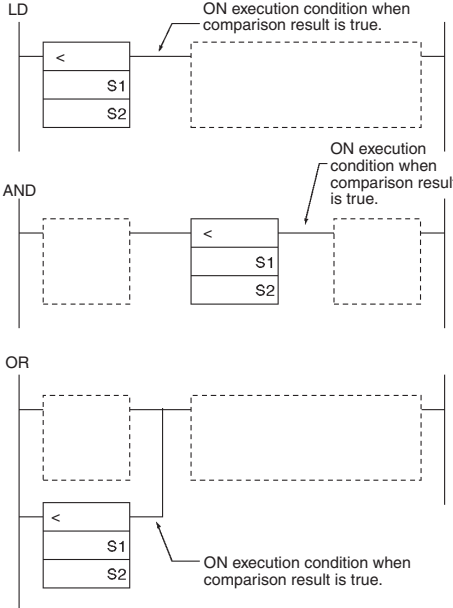
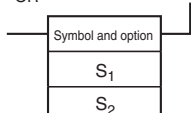
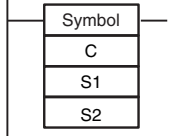
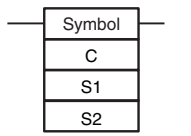
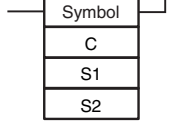
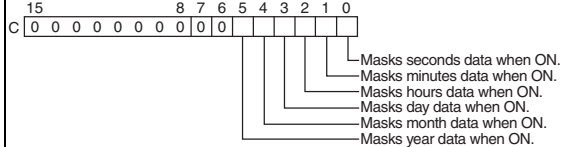
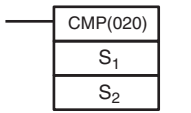
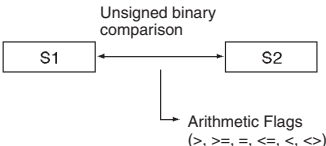
Instruction	Mnemonic	Variations	Symbol/Operand	Function
Symbol Comparison (Unsigned)	LD, AND, OR + =, <>, <, <=, >, >=	---	LD 	Input comparison instructions compare two values (constants and/or the contents of specified words) and create an ON execution condition when the comparison condition is true.
Symbol Comparison (Double-word, unsigned)	LD, AND, OR + =, <>, <, <=, >, >= + L	---	LD 	Input comparison instructions are available to compare signed or unsigned data of one-word or double length data.
Symbol Comparison (Signed)	LD, AND, OR + =, <>, <, <=, >, >= +S	---	AND 	
Symbol Comparison (Double-word, signed)	LD, AND, OR + =, <>, <, <=, >, >= +SL	---	OR   <b>One-word</b> S1: Comparison data 1 S2: Comparison data 2 <b>Double length</b> S1: 1st word of comparison data 1 S2: 1st word of comparison data 2	
Time Comparison	LD, AND, OR + = DT, <> DT, < DT, <= DT, > DT, >= DT	---	LD (LOAD):   AND:   OR:   C: Control word S1: 1st word of present time S2: 1st word of comparison time	Time comparison instructions compare two BCD time values and create an ON execution condition when the comparison condition is true.  There are three types of time comparison instructions, LD (LOAD), AND, and OR. Time values (year, month, day, hour, minute, and second) can be masked/unmasked in the comparison so it is easy to create calendar timer functions.  C: Control Word Bits 00 to 05 of C specify whether or not the time data will be masked for the comparison. Bits 00 to 05 mask the seconds, minutes, hours, day, month, and year, respectively. If all 6 values are masked, the instruction will not be executed, the execution condition will be OFF, and the Error Flag will be turned ON.  
UNSIGNED COMPARE	CMP	!	  S1: Comparison data 1 S2: Comparison data 2	Compares two unsigned binary values (constants and/or the contents of specified words) and outputs the result to the Arithmetic Flags in the Auxiliary Area.  

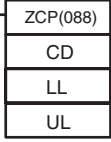
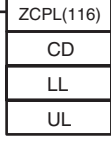

Instruction	Mnemonic	Variations	Symbol/Operand	Function														
DOUBLE UNSIGNED COMPARE	CMPL	---	<div style="border: 1px solid black; padding: 5px; width: fit-content;">                     CMPL(060)  <hr/>                     S<sub>1</sub>  <hr/>                     S<sub>2</sub> </div> <p>S1: Comparison data 1 S2: Comparison data 2</p>	<p>Compares two double unsigned binary values (constants and/or the contents of specified words) and outputs the result to the Arithmetic Flags in the Auxiliary Area.</p>														
SIGNED BINARY COMPARE	CPS	!	<div style="border: 1px solid black; padding: 5px; width: fit-content;">                     CPS(114)  <hr/>                     S<sub>1</sub>  <hr/>                     S<sub>2</sub> </div> <p>S1: Comparison data 1 S2: Comparison data 2</p>	<p>Compares two signed binary values (constants and/or the contents of specified words) and outputs the result to the Arithmetic Flags in the Auxiliary Area.</p>														
DOUBLE SIGNED BINARY COMPARE	CPSL	---	<div style="border: 1px solid black; padding: 5px; width: fit-content;">                     CPSL(115)  <hr/>                     S<sub>1</sub>  <hr/>                     S<sub>2</sub> </div> <p>S1: Comparison data 1 S2: Comparison data 2</p>	<p>Compares two double signed binary values (constants and/or the contents of specified words) and outputs the result to the Arithmetic Flags in the Auxiliary Area.</p>														
TABLE COMPARE	TCMP	@	<div style="border: 1px solid black; padding: 5px; width: fit-content;">                     TCMP(085)  <hr/>                     S  <hr/>                     T  <hr/>                     R                 </div> <p>S: Source data T: 1st word of table R: Result word</p>	<p>Compares the source data to the contents of 16 words and turns ON the corresponding bit in the result word when the contents are equal.</p> <p>T: First word of table</p> <table border="1" style="width: 100%; border-collapse: collapse;"> <tr><td>T</td><td>Comparison data 0</td></tr> <tr><td>T+1</td><td>Comparison data 1</td></tr> <tr><td>to</td><td>to</td></tr> <tr><td>T+15</td><td>Comparison data 15</td></tr> </table>	T	Comparison data 0	T+1	Comparison data 1	to	to	T+15	Comparison data 15						
T	Comparison data 0																	
T+1	Comparison data 1																	
to	to																	
T+15	Comparison data 15																	
UNSIGNED BLOCK COMPARE	BCMP	@	<div style="border: 1px solid black; padding: 5px; width: fit-content;">                     BCMP(068)  <hr/>                     S  <hr/>                     T  <hr/>                     R                 </div> <p>S: Source data T: 1st word of table R: Result word</p>	<p>Compares the source data to 16 ranges (defined by 16 lower limits and 16 upper limits) and turns ON the corresponding bit in the result word when the source data is within the range.</p> <p>B: First word of block</p> <table border="1" style="width: 100%; border-collapse: collapse;"> <tr><td>B</td><td>Lower limit value 0</td></tr> <tr><td>B+1</td><td>Upper limit value 0</td></tr> <tr><td>B+2</td><td>Lower limit value 1</td></tr> <tr><td>B+3</td><td>Upper limit value 1</td></tr> <tr><td>to</td><td>to</td></tr> <tr><td>B+30</td><td>Lower limit value 15</td></tr> <tr><td>B+31</td><td>Upper limit value 15</td></tr> </table>	B	Lower limit value 0	B+1	Upper limit value 0	B+2	Lower limit value 1	B+3	Upper limit value 1	to	to	B+30	Lower limit value 15	B+31	Upper limit value 15
B	Lower limit value 0																	
B+1	Upper limit value 0																	
B+2	Lower limit value 1																	
B+3	Upper limit value 1																	
to	to																	
B+30	Lower limit value 15																	
B+31	Upper limit value 15																	

Instruction	Mnemonic	Variations	Symbol/Operand	Function
AREA RANGE COMPARE	ZCP	---	 <p>CD: Comparison data (1 word) LL: Lower limit of range UL: Upper limit of range</p>	Compares the 16-bit unsigned binary value in CD (word contents or constant) to the range defined by LL and UL and outputs the results to the Arithmetic Flags in the Auxiliary Area.
DOUBLE AREA RANGE COMPARE	ZCPL	---	 <p>CD: Comparison data (2 words) LL: Lower limit of range UL: Upper limit of range</p>	Compares the 32-bit unsigned binary value in CD and CD+1 (word contents or constant) to the range defined by LL and UL and outputs the results to the Arithmetic Flags in the Auxiliary Area.

### A-1-6 Data Movement Instructions

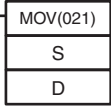
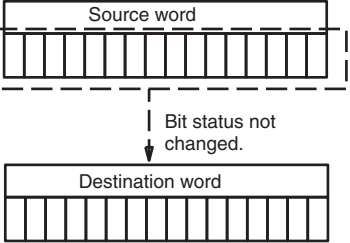
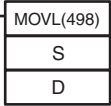
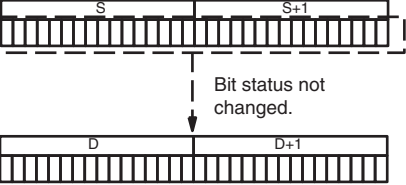
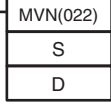
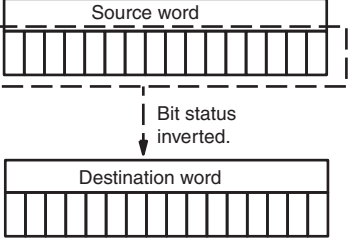
Instruction	Mnemonic	Variations	Symbol/Operand	Function
MOVE	MOV	@/!/@	 <p>S: Source D: Destination</p>	<p>Transfers a word of data to the specified word.</p> 
DOUBLE MOVE	MOVL	@	 <p>S: 1st source word D: 1st destination word</p>	<p>Transfers two words of data to the specified words.</p> 
MOVE NOT	MVN	@	 <p>S: Source D: Destination</p>	<p>Transfers the complement of a word of data to the specified word.</p> 

Instruction	Mnemonic	Variations	Symbol/Operand	Function
MOVE BIT	MOVB	@	<div style="border: 1px solid black; padding: 5px; width: fit-content;"> MOVB(082)  S  C  D </div> <p>S: Source word or data  C: Control word  D: Destination word</p>	<p>Transfers the specified bit.</p> <p>C: Control Word</p>
MOVE DIGIT	MOVD	@	<div style="border: 1px solid black; padding: 5px; width: fit-content;"> MOVD(083)  S  C  D </div> <p>S: Source word or data  C: Control word  D: Destination word</p>	<p>Transfers the specified digit or digits. (Each digit is made up of 4 bits.)</p> <p>C: Control Word</p> <p>0: 1 digit  1: 2 digits  2: 3 digits  3: 4 digits</p>
MULTIPLE BIT TRANSFER	XFRB	@	<div style="border: 1px solid black; padding: 5px; width: fit-content;"> XFRB(062)  C  S  D </div> <p>C: Control word  S: 1st source word  D: 1st destination word</p>	<p>Transfers the specified number of consecutive bits.</p> <p>C: Control Word</p>

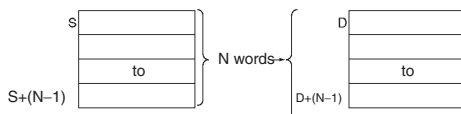
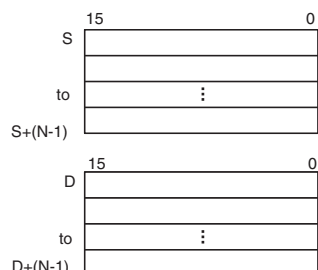
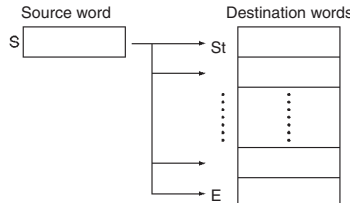
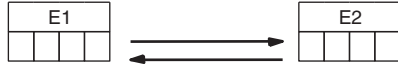
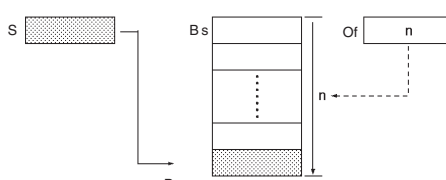
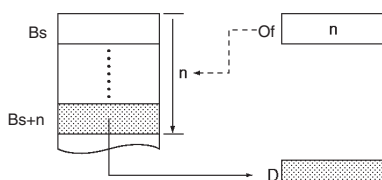
Instruction	Mnemonic	Variations	Symbol/Operand	Function
BLOCK TRANSFER	XFER	@	<div style="border: 1px solid black; padding: 5px; width: fit-content;"> <div style="border: 1px solid black; padding: 2px; text-align: center;">XFER(070)</div> <div style="border: 1px solid black; padding: 2px; text-align: center;">N</div> <div style="border: 1px solid black; padding: 2px; text-align: center;">S</div> <div style="border: 1px solid black; padding: 2px; text-align: center;">D</div> </div> <p>N: Number of words S: 1st source word D: 1st destination word</p>	<p>Transfers the specified number of consecutive words.</p>  <p>N: Number of Words The possible range for N is 0000 to FFFF (0 to 65,535 decimal).</p> 
BLOCK SET	BSET	@	<div style="border: 1px solid black; padding: 5px; width: fit-content;"> <div style="border: 1px solid black; padding: 2px; text-align: center;">BSET(071)</div> <div style="border: 1px solid black; padding: 2px; text-align: center;">S</div> <div style="border: 1px solid black; padding: 2px; text-align: center;">St</div> <div style="border: 1px solid black; padding: 2px; text-align: center;">E</div> </div> <p>S: Source word St: Starting word E: End word</p>	<p>Copies the same word to a range of consecutive words.</p> 
DATA EXCHANGE	XCHG	@	<div style="border: 1px solid black; padding: 5px; width: fit-content;"> <div style="border: 1px solid black; padding: 2px; text-align: center;">XCHG(073)</div> <div style="border: 1px solid black; padding: 2px; text-align: center;">E1</div> <div style="border: 1px solid black; padding: 2px; text-align: center;">E2</div> </div> <p>E1: 1st exchange word E2: Second exchange word</p>	<p>Exchanges the contents of the two specified words.</p> 
SINGLE WORD DISTRIBUTION	DIST	@	<div style="border: 1px solid black; padding: 5px; width: fit-content;"> <div style="border: 1px solid black; padding: 2px; text-align: center;">DIST(080)</div> <div style="border: 1px solid black; padding: 2px; text-align: center;">S</div> <div style="border: 1px solid black; padding: 2px; text-align: center;">Bs</div> <div style="border: 1px solid black; padding: 2px; text-align: center;">Of</div> </div> <p>S: Source word Bs: Destination base address Of: Offset</p>	<p>Transfers the source word to a destination word calculated by adding an offset value to the base address.</p> 
DATA COLLECT	COLL	@	<div style="border: 1px solid black; padding: 5px; width: fit-content;"> <div style="border: 1px solid black; padding: 2px; text-align: center;">COLL(081)</div> <div style="border: 1px solid black; padding: 2px; text-align: center;">Bs</div> <div style="border: 1px solid black; padding: 2px; text-align: center;">Of</div> <div style="border: 1px solid black; padding: 2px; text-align: center;">D</div> </div> <p>Bs: Source base address Of: Offset D: Destination word</p>	<p>Transfers the source word (calculated by adding an offset value to the base address) to the destination word.</p> 







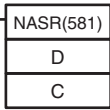
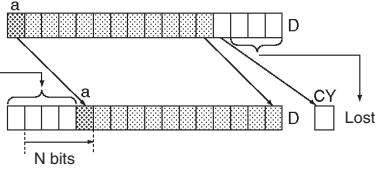
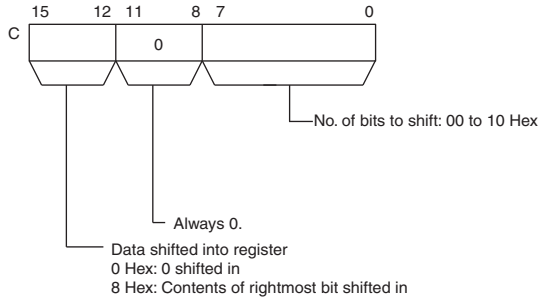
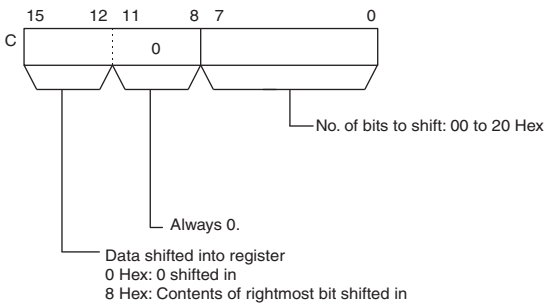
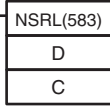

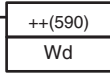

## A-1-7 Data Shift Instructions

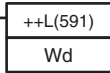
Instruction	Mnemonic	Variations	Symbol/Operand	Function
SHIFT REGISTER	SFT	---	<div style="border: 1px solid black; padding: 5px; width: fit-content;">                     Data input                      Shift input                      Reset input                      SFTR(010)                      St                      E                 </div> <p>St: Starting word E: End word</p>	Operates a shift register.
REVERSIBLE SHIFT REGISTER	SFTR	@	<div style="border: 1px solid black; padding: 5px; width: fit-content;">                     SFTR(084)                      C                      St                      E                 </div> <p>C: Control word St: Starting word E: End word</p>	Creates a shift register that shifts data to either the right or the left. <p><b>C: Control Word</b></p> <div style="border: 1px solid black; padding: 5px; width: fit-content;">                         15 14 13 12                          Shift direction                          1 (ON): Left                          0 (OFF): Right                          Data input                          Shift input                          Reset                     </div>
WORD SHIFT	WSFT	@	<div style="border: 1px solid black; padding: 5px; width: fit-content;">                     WSFT(016)                      S                      St                      E                 </div> <p>S: Source word St: Starting word E: End word</p>	Shifts data between St and E in word units.
ARITHMETIC SHIFT LEFT	ASL	@	<div style="border: 1px solid black; padding: 5px; width: fit-content;">                     ASL(025)                      Wd                 </div> <p>Wd: Word</p>	Shifts the contents of Wd one bit to the left.
ARITHMETIC SHIFT RIGHT	ASR	@	<div style="border: 1px solid black; padding: 5px; width: fit-content;">                     ASR(026)                      Wd                 </div> <p>Wd: Word</p>	Shifts the contents of Wd one bit to the right.
ROTATE LEFT	ROL	@	<div style="border: 1px solid black; padding: 5px; width: fit-content;">                     ROL(027)                      Wd                 </div> <p>Wd: Word</p>	Shifts all Wd bits one bit to the left including the Carry Flag (CY).
ROTATE RIGHT	ROR	@	<div style="border: 1px solid black; padding: 5px; width: fit-content;">                     ROR(028)                      Wd                 </div> <p>Wd: Word</p>	Shifts all Wd bits one bit to the right including the Carry Flag (CY).

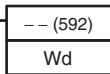
Instruction	Mnemonic	Variations	Symbol/Operand	Function
ONE DIGIT SHIFT LEFT	SLD	@	<div style="border: 1px solid black; padding: 5px; width: fit-content;">                     SLD(074)                      St                      E                 </div> <p>St: Starting word E: End word</p>	Shifts data by one digit (4 bits) to the left. 
ONE DIGIT SHIFT RIGHT	SRD	@	<div style="border: 1px solid black; padding: 5px; width: fit-content;">                     SRD(075)                      St                      E                 </div> <p>St: Starting word E: End word</p>	Shifts data by one digit (4 bits) to the right. 
SHIFT N-BITS LEFT	NASL	@	<div style="border: 1px solid black; padding: 5px; width: fit-content;">                     NASL(580)                      D                      C                 </div> <p>D: Shift word C: Control word</p>	Shifts the specified 16 bits(NASL) or 32 bits(NSLL) of word data to the left by the specified number of bits. 
DOUBLE SHIFT N-BITS LEFT	NSLL	@	<div style="border: 1px solid black; padding: 5px; width: fit-content;">                     NSLL(582)                      D                      C                 </div> <p>D: Shift word C: Control word</p>	<p>C: Control word</p> <ul style="list-style-type: none"> <li>• NASL                           </li> <li>• NSLL                           </li> </ul>

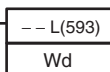
Instruction	Mnemonic	Variations	Symbol/Operand	Function
SHIFT N-BITS RIGHT	NASR	@	 <p>D: Shift word C: Control word</p>	<p>Shifts the specified 16 bits(NASR) or 32 bits(NSRL) of word data to the right by the specified number of bits.</p>  <p>C: Control word</p> <ul style="list-style-type: none"> <li>• NASR            </li> <li>• NSRL            </li> </ul>
DOUBLE SHIFT N-BITS RIGHT	NSRL	@	 <p>D: Shift word C: Control word</p>	

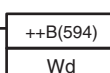
### A-1-8 Increment/Decrement Instructions

Instruction	Mnemonic	Variations	Symbol/Operand	Function
INCREMENT BINARY	++	@	 <p>Wd: Word</p>	<p>Increases the 4-digit hexadecimal content of the specified word by 1.</p> 
DOUBLE INCREMENT BINARY	++L	@	 <p>Wd: Word</p>	<p>Increases the 8-digit hexadecimal content of the specified words by 1.</p> 
DECREMENT BINARY	--	@	 <p>Wd: Word</p>	<p>Decrements the 4-digit hexadecimal content of the specified word by 1.</p> 
DOUBLE DECREMENT BINARY	--L	@	 <p>Wd: 1st word</p>	<p>Decrements the 8-digit hexadecimal content of the specified words by 1.</p> 
INCREMENT BCD	++B	@	 <p>Wd: Word</p>	<p>Increases the 4-digit BCD content of the specified word by 1.</p> 

Instruction	Mnemonic	Variations	Symbol/Operand	Function
DOUBLE INCREMENT BCD	++BL	@	$\begin{array}{ c } \hline ++BL(595) \\ \hline Wd \\ \hline \end{array}$ <p>Wd: 1st word</p>	<p>Increases the 8-digit BCD content of the specified words by 1.</p> $\begin{array}{ c c } \hline Wd+1 & Wd \\ \hline \end{array} +1 \longrightarrow \begin{array}{ c c } \hline Wd+1 & Wd \\ \hline \end{array}$
DECREMENT BCD	--B	@	$\begin{array}{ c } \hline --B(596) \\ \hline Wd \\ \hline \end{array}$ <p>Wd: Word</p>	<p>Decrements the 4-digit BCD content of the specified word by 1.</p> $\begin{array}{ c } \hline Wd \\ \hline \end{array} -1 \longrightarrow \begin{array}{ c } \hline Wd \\ \hline \end{array}$
DOUBLE DECREMENT BCD	--BL	@	$\begin{array}{ c } \hline --BL(597) \\ \hline Wd \\ \hline \end{array}$ <p>Wd: 1st word</p>	<p>Decrements the 8-digit BCD content of the specified words by 1.</p> $\begin{array}{ c c } \hline Wd+1 & Wd \\ \hline \end{array} -1 \longrightarrow \begin{array}{ c c } \hline Wd+1 & Wd \\ \hline \end{array}$

### A-1-9 Symbol Math Instructions

Instruction	Mnemonic	Variations	Symbol/Operand	Function
SIGNED BINARY ADD WITHOUT CARRY	+	@	$\begin{array}{ c } \hline +(400) \\ \hline Au \\ \hline Ad \\ \hline R \\ \hline \end{array}$ <p>Au: Augend word Ad: Addend word R: Result word</p>	<p>Adds 4-digit (single-word) hexadecimal data and/or constants.</p> $\begin{array}{ c } \hline Au \\ \hline \end{array} \text{ (Signed binary)}$ $+ \begin{array}{ c } \hline Ad \\ \hline \end{array} \text{ (Signed binary)}$ <hr/> <p>CY will turn ON when there is a carry.</p> $\begin{array}{ c c } \hline CY & R \\ \hline \end{array} \text{ (Signed binary)}$
DOUBLE SIGNED BINARY ADD WITHOUT CARRY	+L	@	$\begin{array}{ c } \hline +L(401) \\ \hline Au \\ \hline Ad \\ \hline R \\ \hline \end{array}$ <p>Au: 1st augend word Ad: 1st addend word R: 1st result word</p>	<p>Adds 8-digit (double-word) hexadecimal data and/or constants.</p> $\begin{array}{ c c } \hline Au+1 & Au \\ \hline \end{array} \text{ (Signed binary)}$ $+ \begin{array}{ c c } \hline Ad+1 & Ad \\ \hline \end{array} \text{ (Signed binary)}$ <hr/> <p>CY will turn ON when there is a carry.</p> $\begin{array}{ c c c } \hline CY & R+1 & R \\ \hline \end{array} \text{ (Signed binary)}$
SIGNED BINARY ADD WITH CARRY	+C	@	$\begin{array}{ c } \hline +C(402) \\ \hline Au \\ \hline Ad \\ \hline R \\ \hline \end{array}$ <p>Au: Augend word Ad: Addend word R: Result word</p>	<p>Adds 4-digit (single-word) hexadecimal data and/or constants with the Carry Flag (CY).</p> $\begin{array}{ c } \hline Au \\ \hline \end{array} \text{ (Signed binary)}$ $+ \begin{array}{ c } \hline Ad \\ \hline \end{array} \text{ (Signed binary)}$ <hr/> <p>CY will turn ON when there is a carry.</p> $\begin{array}{ c c } \hline CY & R \\ \hline \end{array} \text{ (Signed binary)}$
DOUBLE SIGNED BINARY ADD WITH CARRY	+CL	@	$\begin{array}{ c } \hline +CL(403) \\ \hline Au \\ \hline Ad \\ \hline R \\ \hline \end{array}$ <p>Au: 1st augend word Ad: 1st addend word R: 1st result word</p>	<p>Adds 8-digit (double-word) hexadecimal data and/or constants with the Carry Flag (CY).</p> $\begin{array}{ c c } \hline Au+1 & Au \\ \hline \end{array} \text{ (Signed binary)}$ $+ \begin{array}{ c c } \hline Ad+1 & Ad \\ \hline \end{array} \text{ (Signed binary)}$ <hr/> <p>CY will turn ON when there is a carry.</p> $\begin{array}{ c c c } \hline CY & R+1 & R \\ \hline \end{array} \text{ (Signed binary)}$



Instruction	Mnemonic	Variations	Symbol/Operand	Function
BCD ADD WITHOUT CARRY	+B	@	$\begin{array}{ c } \hline +B(404) \\ \hline Au \\ \hline Ad \\ \hline R \\ \hline \end{array}$ <p>Au: Augend word Ad: Addend word R: Result word</p>	<p>Adds 4-digit (single-word) BCD data and/or constants.</p> $\begin{array}{r} \boxed{Au} \text{ (BCD)} \\ + \boxed{Ad} \text{ (BCD)} \\ \hline \boxed{CY} \quad \boxed{R} \text{ (BCD)} \end{array}$ <p>CY will turn ON when there is a carry.</p>
DOUBLE BCD ADD WITHOUT CARRY	+BL	@	$\begin{array}{ c } \hline +BL(405) \\ \hline Au \\ \hline Ad \\ \hline R \\ \hline \end{array}$ <p>Au: 1st augend word Ad: 1st addend word R: 1st result word</p>	<p>Adds 8-digit (double-word) BCD data and/or constants.</p> $\begin{array}{r} \boxed{Au+1} \quad \boxed{Au} \text{ (BCD)} \\ + \boxed{Ad+1} \quad \boxed{Ad} \text{ (BCD)} \\ \hline \boxed{CY} \quad \boxed{R+1} \quad \boxed{R} \text{ (BCD)} \end{array}$ <p>CY will turn ON when there is a carry.</p>
BCD ADD WITH CARRY	+BC	@	$\begin{array}{ c } \hline +BC(406) \\ \hline Au \\ \hline Ad \\ \hline R \\ \hline \end{array}$ <p>Au: Augend word Ad: Addend word R: Result word</p>	<p>Adds 4-digit (single-word) BCD data and/or constants with the Carry Flag (CY).</p> $\begin{array}{r} \boxed{Au} \text{ (BCD)} \\ \boxed{Ad} \text{ (BCD)} \\ + \boxed{CY} \\ \hline \boxed{CY} \quad \boxed{R} \text{ (BCD)} \end{array}$ <p>CY will turn ON when there is a carry.</p>
DOUBLE BCD ADD WITH CARRY	+BCL	@	$\begin{array}{ c } \hline +BCL(407) \\ \hline Au \\ \hline Ad \\ \hline R \\ \hline \end{array}$ <p>Au: 1st augend word Ad: 1st addend word R: 1st result word</p>	<p>Adds 8-digit (double-word) BCD data and/or constants with the Carry Flag (CY).</p> $\begin{array}{r} \boxed{Au+1} \quad \boxed{Au} \text{ (BCD)} \\ \boxed{Ad+1} \quad \boxed{Ad} \text{ (BCD)} \\ + \boxed{CY} \\ \hline \boxed{CY} \quad \boxed{R+1} \quad \boxed{R} \text{ (BCD)} \end{array}$ <p>CY will turn ON when there is a carry.</p>
SIGNED BINARY SUBTRACT WITHOUT CARRY	-	@	$\begin{array}{ c } \hline -(410) \\ \hline Mi \\ \hline Su \\ \hline R \\ \hline \end{array}$ <p>Mi: Minuend word Su: Subtrahend word R: Result word</p>	<p>Subtracts 4-digit (single-word) hexadecimal data and/or constants.</p> $\begin{array}{r} \boxed{Mi} \text{ (Signed binary)} \\ - \boxed{Su} \text{ (Signed binary)} \\ \hline \boxed{CY} \quad \boxed{R} \text{ (Signed binary)} \end{array}$ <p>CY will turn ON when there is a borrow.</p>
DOUBLE SIGNED BINARY SUBTRACT WITHOUT CARRY	-L	@	$\begin{array}{ c } \hline -L(411) \\ \hline Mi \\ \hline Su \\ \hline R \\ \hline \end{array}$ <p>Mi: Minuend word Su: Subtrahend word R: Result word</p>	<p>Subtracts 8-digit (double-word) hexadecimal data and/or constants.</p> $\begin{array}{r} \boxed{Mi+1} \quad \boxed{Mi} \text{ (Signed binary)} \\ - \boxed{Su+1} \quad \boxed{Su} \text{ (Signed binary)} \\ \hline \boxed{CY} \quad \boxed{R+1} \quad \boxed{R} \text{ (Signed binary)} \end{array}$ <p>CY will turn ON when there is a borrow.</p>

Instruction	Mnemonic	Variations	Symbol/Operand	Function
SIGNED BINARY SUBTRACT WITH CARRY	- C	@	$\begin{array}{r} \text{---} \\ -C(412) \\ \hline \text{Mi} \\ \text{Su} \\ \text{R} \end{array}$ <p>Mi: Minuend word Su: Subtrahend word R: Result word</p>	<p>Subtracts 4-digit (single-word) hexadecimal data and/or constants with the Carry Flag (CY).</p> $\begin{array}{r} \text{Mi} \text{ (Signed binary)} \\ \text{Su} \text{ (Signed binary)} \\ - \\ \text{CY} \\ \hline \text{CY} \text{ R} \text{ (Signed binary)} \end{array}$ <p>CY will turn ON when there is a borrow.</p>
DOUBLE SIGNED BINARY SUBTRACT WITH CARRY	- CL	@	$\begin{array}{r} \text{---} \\ -CL(413) \\ \hline \text{Mi} \\ \text{Su} \\ \text{R} \end{array}$ <p>Mi: Minuend word Su: Subtrahend word R: Result word</p>	<p>Subtracts 8-digit (double-word) hexadecimal data and/or constants with the Carry Flag (CY).</p> $\begin{array}{r} \text{Mi+1} \text{ Mi} \text{ (Signed binary)} \\ \text{Su+1} \text{ Su} \text{ (Signed binary)} \\ - \\ \text{CY} \\ \hline \text{CY} \text{ R+1} \text{ R} \text{ (Signed binary)} \end{array}$ <p>CY will turn ON when there is a borrow.</p>
BCD SUBTRACT WITHOUT CARRY	- B	@	$\begin{array}{r} \text{---} \\ -B(414) \\ \hline \text{Mi} \\ \text{Su} \\ \text{R} \end{array}$ <p>Mi: Minuend word Su: Subtrahend word R: Result word</p>	<p>Subtracts 4-digit (single-word) BCD data and/or constants.</p> $\begin{array}{r} \text{Mi} \text{ (BCD)} \\ \text{Su} \text{ (BCD)} \\ - \\ \hline \text{CY} \text{ R} \text{ (BCD)} \end{array}$ <p>CY will turn ON when there is a carry.</p>
DOUBLE BCD SUBTRACT WITHOUT CARRY	- BL	@	$\begin{array}{r} \text{---} \\ -BL(415) \\ \hline \text{Mi} \\ \text{Su} \\ \text{R} \end{array}$ <p>Mi: 1st minuend word Su: 1st subtrahend word R: 1st result word</p>	<p>Subtracts 8-digit (double-word) BCD data and/or constants.</p> $\begin{array}{r} \text{Mi+1} \text{ Mi} \text{ (BCD)} \\ \text{Su+1} \text{ Su} \text{ (BCD)} \\ - \\ \hline \text{CY} \text{ R+1} \text{ R} \text{ (BCD)} \end{array}$ <p>CY will turn ON when there is a borrow.</p>
BCD SUBTRACT WITH CARRY	- BC	@	$\begin{array}{r} \text{---} \\ -BC(416) \\ \hline \text{Mi} \\ \text{Su} \\ \text{R} \end{array}$ <p>Mi: Minuend word Su: Subtrahend word R: Result word</p>	<p>Subtracts 4-digit (single-word) BCD data and/or constants with the Carry Flag (CY).</p> $\begin{array}{r} \text{Mi} \text{ (BCD)} \\ \text{Su} \text{ (BCD)} \\ - \\ \text{CY} \\ \hline \text{CY} \text{ R} \text{ (BCD)} \end{array}$ <p>CY will turn ON when there is a borrow.</p>
DOUBLE BCD SUBTRACT WITH CARRY	- BCL	@	$\begin{array}{r} \text{---} \\ -BCL(417) \\ \hline \text{Mi} \\ \text{Su} \\ \text{R} \end{array}$ <p>Mi: 1st minuend word Su: 1st subtrahend word R: 1st result word</p>	<p>Subtracts 8-digit (double-word) BCD data and/or constants with the Carry Flag (CY).</p> $\begin{array}{r} \text{Mi+1} \text{ Mi} \text{ (BCD)} \\ \text{Su+1} \text{ Su} \text{ (BCD)} \\ - \\ \text{CY} \\ \hline \text{CY} \text{ R+1} \text{ R} \text{ (BCD)} \end{array}$ <p>CY will turn ON when there is a borrow.</p>

Instruction	Mnemonic	Variations	Symbol/Operand	Function
SIGNED BINARY MULTIPLY	*	@	$\begin{array}{ c } \hline *(420) \\ \hline Md \\ \hline Mr \\ \hline R \\ \hline \end{array}$ <p>Md: Multiplicand word Mr: Multiplier word R: Result word</p>	<p>Multiplies 4-digit signed hexadecimal data and/or constants.</p> $\begin{array}{r} \boxed{Md} \text{ (Signed binary)} \\ \times \boxed{Mr} \text{ (Signed binary)} \\ \hline \boxed{R+1} \quad \boxed{R} \text{ (Signed binary)} \end{array}$
DOUBLE SIGNED BINARY MULTIPLY	*L	@	$\begin{array}{ c } \hline *L(421) \\ \hline Md \\ \hline Mr \\ \hline R \\ \hline \end{array}$ <p>Md: 1st multiplicand word Mr: 1st multiplier word R: 1st result word</p>	<p>Multiplies 8-digit signed hexadecimal data and/or constants.</p> $\begin{array}{r} \boxed{Md+1} \quad \boxed{Md} \text{ (Signed binary)} \\ \times \boxed{Mr+1} \quad \boxed{Mr} \text{ (Signed binary)} \\ \hline \boxed{R+3} \quad \boxed{R+2} \quad \boxed{R+1} \quad \boxed{R} \text{ (Signed binary)} \end{array}$
BCD MULTIPLY	*B	@	$\begin{array}{ c } \hline *B(424) \\ \hline Md \\ \hline Mr \\ \hline R \\ \hline \end{array}$ <p>Md: Multiplicand word Mr: Multiplier word R: Result word</p>	<p>Multiplies 4-digit (single-word) BCD data and/or constants.</p> $\begin{array}{r} \boxed{Md} \text{ (BCD)} \\ \times \boxed{Mr} \text{ (BCD)} \\ \hline \boxed{R+1} \quad \boxed{R} \text{ (BCD)} \end{array}$
DOUBLE BCD MULTIPLY	*BL	@	$\begin{array}{ c } \hline *BL(425) \\ \hline Md \\ \hline Mr \\ \hline R \\ \hline \end{array}$ <p>Md: 1st multiplicand word Mr: 1st multiplier word R: 1st result word</p>	<p>Multiplies 8-digit (double-word) BCD data and/or constants.</p> $\begin{array}{r} \boxed{Md+1} \quad \boxed{Md} \text{ (BCD)} \\ \times \boxed{Mr+1} \quad \boxed{Mr} \text{ (BCD)} \\ \hline \boxed{R+3} \quad \boxed{R+2} \quad \boxed{R+1} \quad \boxed{R} \text{ (BCD)} \end{array}$
SIGNED BINARY DIVIDE	/	@	$\begin{array}{ c } \hline /(430) \\ \hline Dd \\ \hline Dr \\ \hline R \\ \hline \end{array}$ <p>Dd: Dividend word Dr: Divisor word R: Result word</p>	<p>Divides 4-digit (single-word) signed hexadecimal data and/or constants.</p> $\begin{array}{r} \boxed{Dd} \text{ (Signed binary)} \\ \div \boxed{Dr} \text{ (Signed binary)} \\ \hline \boxed{R+1} \quad \boxed{R} \text{ (Signed binary)} \end{array}$ <p>Remainder      Quotient</p>
DOUBLE SIGNED BINARY DIVIDE	/L	@	$\begin{array}{ c } \hline /L(431) \\ \hline Dd \\ \hline Dr \\ \hline R \\ \hline \end{array}$ <p>Dd: 1st dividend word Dr: 1st divisor word R: 1st result word</p>	<p>Divides 8-digit (double-word) signed hexadecimal data and/or constants.</p> $\begin{array}{r} \boxed{Dd+1} \quad \boxed{Dd} \text{ (Signed binary)} \\ \div \boxed{Dr+1} \quad \boxed{Dr} \text{ (Signed binary)} \\ \hline \boxed{R+3} \quad \boxed{R+2} \quad \boxed{R+1} \quad \boxed{R} \text{ (Signed binary)} \end{array}$ <p>Remainder      Quotient</p>
BCD DIVIDE	/B	@	$\begin{array}{ c } \hline /B(434) \\ \hline Dd \\ \hline Dr \\ \hline R \\ \hline \end{array}$ <p>Dd: Dividend word Dr: Divisor word R: Result word</p>	<p>Divides 4-digit (single-word) BCD data and/or constants.</p> $\begin{array}{r} \boxed{Dd} \text{ (BCD)} \\ \div \boxed{Dr} \text{ (BCD)} \\ \hline \boxed{R+1} \quad \boxed{R} \text{ (BCD)} \end{array}$ <p>Remainder      Quotient</p>

Instruction	Mnemonic	Variations	Symbol/Operand	Function
DOUBLE BCD DIVIDE	/BL	@	<div style="border: 1px solid black; padding: 5px; width: fit-content;">                     /BL(435)                      Dd                      Dr                      R                 </div> <p>Dd: 1st dividend word Dr: 1st divisor word R: 1st result word</p>	Divides 8-digit (double-word) BCD data and/or constants. <div style="margin-top: 10px;"> <math display="block">\begin{array}{r} \boxed{Dd + 1} \quad \boxed{Dd} \text{ (BCD)} \\ \div \quad \boxed{Dr + 1} \quad \boxed{Dr} \text{ (BCD)} \\ \hline \boxed{R + 3} \quad \boxed{R + 2} \quad \boxed{R + 1} \quad \boxed{R} \text{ (BCD)} \\ \text{Remainder} \quad \text{Quotient} \end{array}</math> </div>

## A-1-10 Conversion Instructions

Instruction	Mnemonic	Variations	Symbol/Operand	Function
BCD-TO-BINARY	BIN	@	<div style="border: 1px solid black; padding: 5px; width: fit-content;">                     BIN(023)                      S                      R                 </div> <p>S: Source word R: Result word</p>	Converts BCD data to binary data. $S \text{ (BCD)} \longrightarrow R \text{ (BIN)}$
DOUBLE BCD-TO-DOUBLE BINARY	BINL	@	<div style="border: 1px solid black; padding: 5px; width: fit-content;">                     BINL(058)                      S                      R                 </div> <p>S: 1st source word R: 1st result word</p>	Converts 8-digit BCD data to 8-digit hexadecimal (32-bit binary) data. $\begin{array}{ccc} S \text{ (BCD)} & \longrightarrow & R \text{ (BIN)} \\ S+1 \text{ (BCD)} & \longrightarrow & R+1 \text{ (BIN)} \end{array}$
BINARY-TO-BCD	BCD	@	<div style="border: 1px solid black; padding: 5px; width: fit-content;">                     BCD(024)                      S                      R                 </div> <p>S: Source word R: Result word</p>	Converts a word of binary data to a word of BCD data. $S \text{ (BIN)} \longrightarrow R \text{ (BCD)}$
DOUBLE BINARY-TO-DOUBLE BCD	BCDL	@	<div style="border: 1px solid black; padding: 5px; width: fit-content;">                     BCDL(059)                      S                      R                 </div> <p>S: 1st source word R: 1st result word</p>	Converts 8-digit hexadecimal (32-bit binary) data to 8-digit BCD data. $\begin{array}{ccc} S \text{ (BIN)} & \longrightarrow & R \text{ (BCD)} \\ S+1 \text{ (BIN)} & \longrightarrow & R+1 \text{ (BCD)} \end{array}$
2'S COMPLEMENT	NEG	@	<div style="border: 1px solid black; padding: 5px; width: fit-content;">                     NEG(160)                      S                      R                 </div> <p>S: Source word R: Result word</p>	Calculates the 2's complement of a word of hexadecimal data. $\overline{(S)} \longrightarrow (R)$ <p style="font-size: small;">2's complement (Complement + 1)</p>

Instruction	Mnemonic	Variations	Symbol/Operand	Function
DATA DECODER	MLPX	@	<div style="border: 1px solid black; padding: 5px; margin-bottom: 5px;">MLPX(076)</div> <div style="border: 1px solid black; padding: 2px; margin-bottom: 2px;">S</div> <div style="border: 1px solid black; padding: 2px; margin-bottom: 2px;">C</div> <div style="border: 1px solid black; padding: 2px;">R</div> <p>S: Source word C: Control word R: 1st result word</p>	<p>Reads the numerical value in the specified digit (or byte) in the source word, turns ON the corresponding bit in the result word (or 16-word range), and turns OFF all other bits in the result word (or 16-word range).</p> <p>4-to-16 bit conversion</p> <p>8-to-256 bit conversion</p> <p>C: Control Word</p> <ul style="list-style-type: none"> <li>4-to-16 bit decoder              </li> <li>8-to-256 bit conversion              </li> </ul>

Instruction	Mnemonic	Variations	Symbol/Operand	Function
DATA ENCODER	DMPX	@	<div style="border: 1px solid black; padding: 2px; width: fit-content;">                     DMPX(077)                 </div> <div style="border: 1px solid black; padding: 2px; width: fit-content; margin: 2px;">                     S                 </div> <div style="border: 1px solid black; padding: 2px; width: fit-content; margin: 2px;">                     R                 </div> <div style="border: 1px solid black; padding: 2px; width: fit-content; margin: 2px;">                     C                 </div> <p>S: 1st source word R: Result word C: Control word</p>	<p> Finds the location of the first or last ON bit within the source word (or 16-word range), and writes that value to the specified digit (or byte) in the result word.</p> <p><b>16-to-4 bit conversion</b></p> <p><b>256-to-8 bit conversion</b></p> <p><b>C: Control Word</b></p> <ul style="list-style-type: none"> <li><b>16-to-4 bit conversion</b> <ul style="list-style-type: none"> <li>Specifies the first digit/byte to receive converted data. 0 to 3 (digit 0 to 3)</li> <li>Number of digits/bytes to be converted 0 to 3 (1 to 4 digits)</li> <li>Bit to encode 0: Leftmost bit (highest bit address) 1: Rightmost bit (lowest bit address)</li> <li>Conversion process 0: 16-to-4 bits (word to digit)</li> </ul> </li> <li><b>256-to-8 bit conversion</b> <ul style="list-style-type: none"> <li>Specifies the first digit/byte to receive converted data. 0 or 1 (byte 0 or 1)</li> <li>Number of digits/bytes to be converted 0 or 1 (1 or 2 bytes)</li> <li>Bit to encode 0: Leftmost bit (highest bit address) 1: Rightmost bit (lowest bit address)</li> <li>Conversion process 1: 256-to-8 bits (16-word range to byte)</li> </ul> </li> </ul>

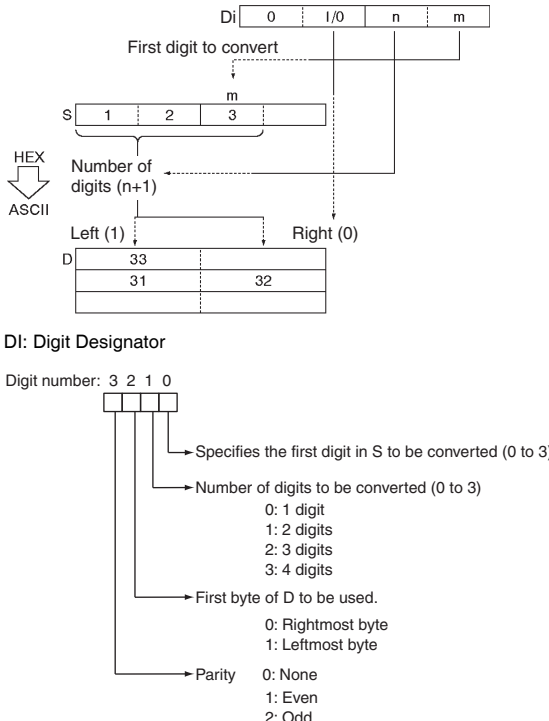
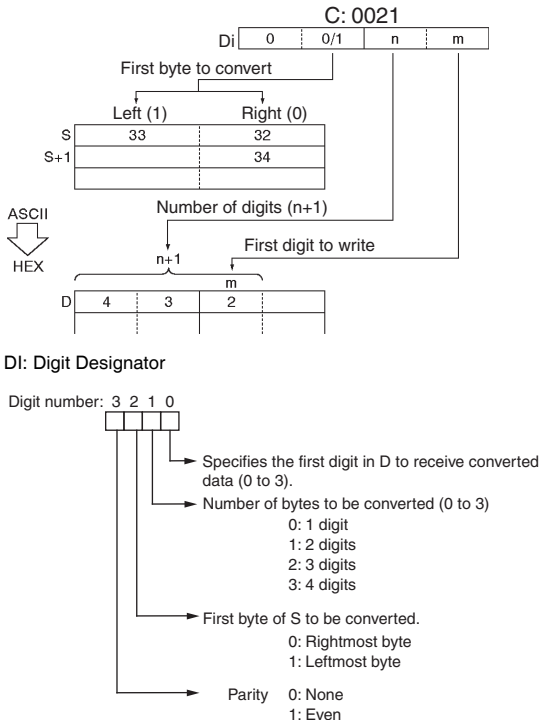
Instruction	Mnemonic	Variations	Symbol/Operand	Function
ASCII CON- VERT	ASC	@	<div style="border: 1px solid black; padding: 5px; width: fit-content;">                     ASC(086)                      S                      Di                      D                 </div> <p>S: Source word                      Di: Digit designator                      D: 1st destination word</p>	<p>Converts 4-bit hexadecimal digits in the source word into their 8-bit ASCII equivalents.</p>  <p>DI: Digit Designator</p> <p>Digit number: 3 2 1 0</p> <ul style="list-style-type: none"> <li>→ Specifies the first digit in S to be converted (0 to 3).</li> <li>→ Number of digits to be converted (0 to 3)                         <ul style="list-style-type: none"> <li>0: 1 digit</li> <li>1: 2 digits</li> <li>2: 3 digits</li> <li>3: 4 digits</li> </ul> </li> <li>→ First byte of D to be used.                         <ul style="list-style-type: none"> <li>0: Rightmost byte</li> <li>1: Leftmost byte</li> </ul> </li> <li>→ Parity                         <ul style="list-style-type: none"> <li>0: None</li> <li>1: Even</li> <li>2: Odd</li> </ul> </li> </ul>
ASCII TO HEX	HEX	@	<div style="border: 1px solid black; padding: 5px; width: fit-content;">                     HEX(162)                      S                      Di                      D                 </div> <p>S: 1st source word                      Di: Digit designator                      D: Destination word</p>	<p>Converts up to 4 bytes of ASCII data in the source word to their hexadecimal equivalents and writes these digits in the specified destination word.</p>  <p>DI: Digit Designator</p> <p>Digit number: 3 2 1 0</p> <ul style="list-style-type: none"> <li>→ Specifies the first digit in D to receive converted data (0 to 3).</li> <li>→ Number of bytes to be converted (0 to 3)                         <ul style="list-style-type: none"> <li>0: 1 digit</li> <li>1: 2 digits</li> <li>2: 3 digits</li> <li>3: 4 digits</li> </ul> </li> <li>→ First byte of S to be converted.                         <ul style="list-style-type: none"> <li>0: Rightmost byte</li> <li>1: Leftmost byte</li> </ul> </li> <li>→ Parity                         <ul style="list-style-type: none"> <li>0: None</li> <li>1: Even</li> <li>2: Odd</li> </ul> </li> </ul>

## A-1-11 Logic Instructions

Instruction	Mnemonic	Variations	Symbol/Operand	Function															
LOGICAL AND	ANDW	@	<div style="border: 1px solid black; padding: 5px; width: fit-content;">                     ANDW(034)  <hr/> <math>I_1</math>  <hr/> <math>I_2</math>  <hr/> <math>R</math> </div> <p>I1: Input 1 I2: Input 2 R: Result word</p>	Takes the logical AND of corresponding bits in single words of word data and/or constants.  $I_1 \cdot I_2 \rightarrow R$ <table border="1" style="margin-left: auto; margin-right: auto;"> <thead> <tr> <th><math>I_1</math></th> <th><math>I_2</math></th> <th>R</th> </tr> </thead> <tbody> <tr><td>1</td><td>1</td><td>1</td></tr> <tr><td>1</td><td>0</td><td>0</td></tr> <tr><td>0</td><td>1</td><td>0</td></tr> <tr><td>0</td><td>0</td><td>0</td></tr> </tbody> </table>	$I_1$	$I_2$	R	1	1	1	1	0	0	0	1	0	0	0	0
$I_1$	$I_2$	R																	
1	1	1																	
1	0	0																	
0	1	0																	
0	0	0																	
DOUBLE LOGICAL AND	ANDL	@	<div style="border: 1px solid black; padding: 5px; width: fit-content;">                     ANDL(610)  <hr/> <math>I_1</math>  <hr/> <math>I_2</math>  <hr/> <math>R</math> </div> <p>I1: Input 1 I2: Input 2 R: Result word</p>	Takes the logical AND of corresponding bits in double words of word data and/or constants.  $(I_1, I_1+1) \cdot (I_2, I_2+1) \rightarrow (R, R+1)$ <table border="1" style="margin-left: auto; margin-right: auto;"> <thead> <tr> <th><math>I_1, I_1+1</math></th> <th><math>I_2, I_2+1</math></th> <th>R, R+1</th> </tr> </thead> <tbody> <tr><td>1</td><td>1</td><td>1</td></tr> <tr><td>1</td><td>0</td><td>0</td></tr> <tr><td>0</td><td>1</td><td>0</td></tr> <tr><td>0</td><td>0</td><td>0</td></tr> </tbody> </table>	$I_1, I_1+1$	$I_2, I_2+1$	R, R+1	1	1	1	1	0	0	0	1	0	0	0	0
$I_1, I_1+1$	$I_2, I_2+1$	R, R+1																	
1	1	1																	
1	0	0																	
0	1	0																	
0	0	0																	
LOGICAL OR	ORW	@	<div style="border: 1px solid black; padding: 5px; width: fit-content;">                     ORW(035)  <hr/> <math>I_1</math>  <hr/> <math>I_2</math>  <hr/> <math>R</math> </div> <p>I1: Input 1 I2: Input 2 R: Result word</p>	Takes the logical OR of corresponding bits in single words of word data and/or constants.  $I_1 + I_2 \rightarrow R$ <table border="1" style="margin-left: auto; margin-right: auto;"> <thead> <tr> <th><math>I_1</math></th> <th><math>I_2</math></th> <th>R</th> </tr> </thead> <tbody> <tr><td>1</td><td>1</td><td>1</td></tr> <tr><td>1</td><td>0</td><td>1</td></tr> <tr><td>0</td><td>1</td><td>1</td></tr> <tr><td>0</td><td>0</td><td>0</td></tr> </tbody> </table>	$I_1$	$I_2$	R	1	1	1	1	0	1	0	1	1	0	0	0
$I_1$	$I_2$	R																	
1	1	1																	
1	0	1																	
0	1	1																	
0	0	0																	
DOUBLE LOGICAL OR	ORWL	@	<div style="border: 1px solid black; padding: 5px; width: fit-content;">                     ORWL(611)  <hr/> <math>I_1</math>  <hr/> <math>I_2</math>  <hr/> <math>R</math> </div> <p>I1: Input 1 I2: Input 2 R: Result word</p>	Takes the logical OR of corresponding bits in double words of word data and/or constants.  $(I_1, I_1+1) + (I_2, I_2+1) \rightarrow (R, R+1)$ <table border="1" style="margin-left: auto; margin-right: auto;"> <thead> <tr> <th><math>I_1, I_1+1</math></th> <th><math>I_2, I_2+1</math></th> <th>R, R+1</th> </tr> </thead> <tbody> <tr><td>1</td><td>1</td><td>1</td></tr> <tr><td>1</td><td>0</td><td>1</td></tr> <tr><td>0</td><td>1</td><td>1</td></tr> <tr><td>0</td><td>0</td><td>0</td></tr> </tbody> </table>	$I_1, I_1+1$	$I_2, I_2+1$	R, R+1	1	1	1	1	0	1	0	1	1	0	0	0
$I_1, I_1+1$	$I_2, I_2+1$	R, R+1																	
1	1	1																	
1	0	1																	
0	1	1																	
0	0	0																	
EXCLUSIVE OR	XORW	@	<div style="border: 1px solid black; padding: 5px; width: fit-content;">                     XORW(036)  <hr/> <math>I_1</math>  <hr/> <math>I_2</math>  <hr/> <math>R</math> </div> <p>I1: Input 1 I2: Input 2 R: Result word</p>	Takes the logical exclusive OR of corresponding bits in single words of word data and/or constants.  $I_1 \cdot I_2 + I_1 \cdot \overline{I_2} \rightarrow R$ <table border="1" style="margin-left: auto; margin-right: auto;"> <thead> <tr> <th><math>I_1</math></th> <th><math>I_2</math></th> <th>R</th> </tr> </thead> <tbody> <tr><td>1</td><td>1</td><td>0</td></tr> <tr><td>1</td><td>0</td><td>1</td></tr> <tr><td>0</td><td>1</td><td>1</td></tr> <tr><td>0</td><td>0</td><td>0</td></tr> </tbody> </table>	$I_1$	$I_2$	R	1	1	0	1	0	1	0	1	1	0	0	0
$I_1$	$I_2$	R																	
1	1	0																	
1	0	1																	
0	1	1																	
0	0	0																	
DOUBLE EXCLUSIVE OR	XORL	@	<div style="border: 1px solid black; padding: 5px; width: fit-content;">                     XORL(612)  <hr/> <math>I_1</math>  <hr/> <math>I_2</math>  <hr/> <math>R</math> </div> <p>I1: Input 1 I2: Input 2 R: Result word</p>	Takes the logical exclusive OR of corresponding bits in double words of word data and/or constants.  $(I_1, I_1+1) \cdot (\overline{I_2, I_2+1}) + (\overline{I_1, I_1+1}) \cdot (I_2, I_2+1) \rightarrow (R, R+1)$ <table border="1" style="margin-left: auto; margin-right: auto;"> <thead> <tr> <th><math>I_1, I_1+1</math></th> <th><math>I_2, I_2+1</math></th> <th>R, R+1</th> </tr> </thead> <tbody> <tr><td>1</td><td>1</td><td>0</td></tr> <tr><td>1</td><td>0</td><td>1</td></tr> <tr><td>0</td><td>1</td><td>1</td></tr> <tr><td>0</td><td>0</td><td>0</td></tr> </tbody> </table>	$I_1, I_1+1$	$I_2, I_2+1$	R, R+1	1	1	0	1	0	1	0	1	1	0	0	0
$I_1, I_1+1$	$I_2, I_2+1$	R, R+1																	
1	1	0																	
1	0	1																	
0	1	1																	
0	0	0																	

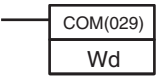
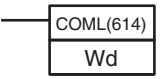

Instruction	Mnemonic	Variations	Symbol/Operand	Function
COMPLEMENT	COM	@	 <p>Wd: Word</p>	Turns OFF all ON bits and turns ON all OFF bits in Wd. $\overline{Wd} \rightarrow Wd: 1 \rightarrow 0 \text{ and } 0 \rightarrow 1$
DOUBLE COMPLEMENT	COML	@	 <p>Wd: Word</p>	Turns OFF all ON bits and turns ON all OFF bits in Wd and Wd+1. $\overline{(Wd+1, Wd)} \rightarrow (Wd+1, Wd)$

## A-1-12 Special Math Instructions

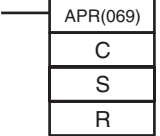
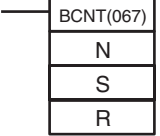
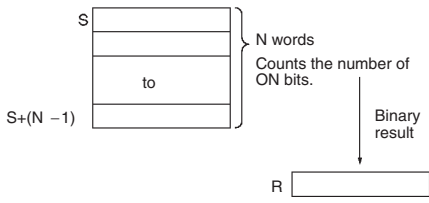
Instruction	Mnemonic	Variations	Symbol/Operand	Function
ARITHMETIC PROCESS	APR	@	 <p>C: Control word S: Source data R: Result word</p>	Calculates the sine, cosine, or a linear extrapolation of the source data. The linear extrapolation function allows any relationship between X and Y to be approximated with line segments.
BIT COUNTER	BCNT	@	 <p>N: Number of words S: 1st source word R: Result word</p>	Counts the total number of ON bits in the specified word(s).  <p>N: Number of words The number of words must be 0001 to FFFF (1 to 65,535 words).</p>

## A-1-13 Floating-point Math Instructions

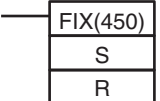
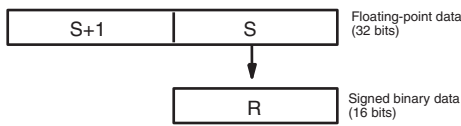
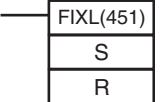
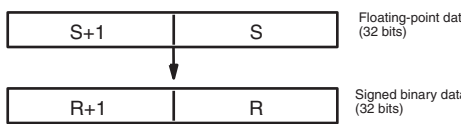
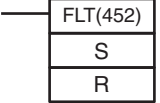
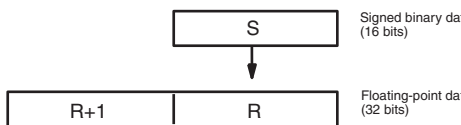
Instruction	Mnemonic	Variations	Symbol/Operand	Function
FLOATING TO 16-BIT	FIX	@	 <p>S: 1st source word R: Result word</p>	Converts a 32-bit floating-point value to 16-bit signed binary data and places the result in the specified result word. 
FLOATING TO 32-BIT	FIXL	@	 <p>S: 1st source word R: 1st result word</p>	Converts a 32-bit floating-point value to 32-bit signed binary data and places the result in the specified result words. 
16-BIT TO FLOATING	FLT	@	 <p>S: Source word R: 1st result word</p>	Converts a 16-bit signed binary value to 32-bit floating-point data and places the result in the specified result words. 

Instruction	Mnemonic	Variations	Symbol/Operand	Function
32-BIT TO FLOATING	FTL	@	<div style="border: 1px solid black; padding: 5px; width: fit-content;"> <div style="border: 1px solid black; padding: 2px; text-align: center;">FTL(453)</div> <div style="border: 1px solid black; padding: 2px; text-align: center;">S</div> <div style="border: 1px solid black; padding: 2px; text-align: center;">R</div> </div> <p>S: 1st source word R: 1st result word</p>	<p>Converts a 32-bit signed binary value to 32-bit floating-point data and places the result in the specified result words.</p> <div style="display: flex; align-items: center; margin-bottom: 10px;"> <div style="border: 1px solid black; padding: 2px; margin-right: 5px;">S+1</div> <div style="border: 1px solid black; padding: 2px; margin-right: 5px;">S</div> <div style="margin-left: 10px;">Signed binary data (32 bits)</div> </div> <p style="text-align: center;">↓</p> <div style="display: flex; align-items: center;"> <div style="border: 1px solid black; padding: 2px; margin-right: 5px;">R+1</div> <div style="border: 1px solid black; padding: 2px; margin-right: 5px;">R</div> <div style="margin-left: 10px;">Floating-point data (32 bits)</div> </div>
FLOATING-POINT ADD	+F	@	<div style="border: 1px solid black; padding: 5px; width: fit-content;"> <div style="border: 1px solid black; padding: 2px; text-align: center;">+F(454)</div> <div style="border: 1px solid black; padding: 2px; text-align: center;">Au</div> <div style="border: 1px solid black; padding: 2px; text-align: center;">Ad</div> <div style="border: 1px solid black; padding: 2px; text-align: center;">R</div> </div> <p>Au: 1st augend word Ad: 1st addend word R: 1st result word</p>	<p>Adds two 32-bit floating-point numbers and places the result in the specified result words.</p> <div style="display: flex; align-items: center; margin-bottom: 10px;"> <div style="border: 1px solid black; padding: 2px; margin-right: 5px;">Au+1</div> <div style="border: 1px solid black; padding: 2px; margin-right: 5px;">Au</div> <div style="margin-left: 10px;">Augend (floating-point data, 32 bits)</div> </div> <p style="margin-left: 20px;">+</p> <div style="display: flex; align-items: center; margin-bottom: 10px;"> <div style="border: 1px solid black; padding: 2px; margin-right: 5px;">Ad+1</div> <div style="border: 1px solid black; padding: 2px; margin-right: 5px;">Ad</div> <div style="margin-left: 10px;">Addend (floating-point data, 32 bits)</div> </div> <hr style="width: 100%; border: 0.5px solid black;"/> <div style="display: flex; align-items: center;"> <div style="border: 1px solid black; padding: 2px; margin-right: 5px;">R+1</div> <div style="border: 1px solid black; padding: 2px; margin-right: 5px;">R</div> <div style="margin-left: 10px;">Result (floating-point data, 32 bits)</div> </div>
FLOATING-POINT SUBTRACT	-F	@	<div style="border: 1px solid black; padding: 5px; width: fit-content;"> <div style="border: 1px solid black; padding: 2px; text-align: center;">-F(455)</div> <div style="border: 1px solid black; padding: 2px; text-align: center;">Mi</div> <div style="border: 1px solid black; padding: 2px; text-align: center;">Su</div> <div style="border: 1px solid black; padding: 2px; text-align: center;">R</div> </div> <p>Mi: 1st Minuend word Su: 1st Subtrahend word R: 1st result word</p>	<p>Subtracts one 32-bit floating-point number from another and places the result in the specified result words.</p> <div style="display: flex; align-items: center; margin-bottom: 10px;"> <div style="border: 1px solid black; padding: 2px; margin-right: 5px;">Mi+1</div> <div style="border: 1px solid black; padding: 2px; margin-right: 5px;">Mi</div> <div style="margin-left: 10px;">Minuend (floating-point data, 32 bits)</div> </div> <p style="margin-left: 20px;">-</p> <div style="display: flex; align-items: center; margin-bottom: 10px;"> <div style="border: 1px solid black; padding: 2px; margin-right: 5px;">Su+1</div> <div style="border: 1px solid black; padding: 2px; margin-right: 5px;">Su</div> <div style="margin-left: 10px;">Subtrahend (floating-point data, 32 bits)</div> </div> <hr style="width: 100%; border: 0.5px solid black;"/> <div style="display: flex; align-items: center;"> <div style="border: 1px solid black; padding: 2px; margin-right: 5px;">R+1</div> <div style="border: 1px solid black; padding: 2px; margin-right: 5px;">R</div> <div style="margin-left: 10px;">Result (floating-point data, 32 bits)</div> </div>
FLOATING-POINT MULTIPLY	*F	@	<div style="border: 1px solid black; padding: 5px; width: fit-content;"> <div style="border: 1px solid black; padding: 2px; text-align: center;">*F(456)</div> <div style="border: 1px solid black; padding: 2px; text-align: center;">Md</div> <div style="border: 1px solid black; padding: 2px; text-align: center;">Mr</div> <div style="border: 1px solid black; padding: 2px; text-align: center;">R</div> </div> <p>Md: 1st Multiplicand word Mr: 1st Multiplier word R: 1st result word</p>	<p>Multiplies two 32-bit floating-point numbers and places the result in the specified result words.</p> <div style="display: flex; align-items: center; margin-bottom: 10px;"> <div style="border: 1px solid black; padding: 2px; margin-right: 5px;">Md+1</div> <div style="border: 1px solid black; padding: 2px; margin-right: 5px;">Md</div> <div style="margin-left: 10px;">Multiplicand (floating-point data, 32 bits)</div> </div> <p style="margin-left: 20px;">×</p> <div style="display: flex; align-items: center; margin-bottom: 10px;"> <div style="border: 1px solid black; padding: 2px; margin-right: 5px;">Mr+1</div> <div style="border: 1px solid black; padding: 2px; margin-right: 5px;">Mr</div> <div style="margin-left: 10px;">Multiplier (floating-point data, 32 bits)</div> </div> <hr style="width: 100%; border: 0.5px solid black;"/> <div style="display: flex; align-items: center;"> <div style="border: 1px solid black; padding: 2px; margin-right: 5px;">R+1</div> <div style="border: 1px solid black; padding: 2px; margin-right: 5px;">R</div> <div style="margin-left: 10px;">Result (floating-point data, 32 bits)</div> </div>
FLOATING-POINT DIVIDE	/F	@	<div style="border: 1px solid black; padding: 5px; width: fit-content;"> <div style="border: 1px solid black; padding: 2px; text-align: center;">/F(457)</div> <div style="border: 1px solid black; padding: 2px; text-align: center;">Dd</div> <div style="border: 1px solid black; padding: 2px; text-align: center;">Dr</div> <div style="border: 1px solid black; padding: 2px; text-align: center;">R</div> </div> <p>Dd: 1st Dividend word Dr: 1st Divisor word R: 1st result word</p>	<p>Divides one 32-bit floating-point number by another and places the result in the specified result words.</p> <div style="display: flex; align-items: center; margin-bottom: 10px;"> <div style="border: 1px solid black; padding: 2px; margin-right: 5px;">Dd+1</div> <div style="border: 1px solid black; padding: 2px; margin-right: 5px;">Dd</div> <div style="margin-left: 10px;">Dividend (floating-point data, 32 bits)</div> </div> <p style="margin-left: 20px;">÷</p> <div style="display: flex; align-items: center; margin-bottom: 10px;"> <div style="border: 1px solid black; padding: 2px; margin-right: 5px;">Dr+1</div> <div style="border: 1px solid black; padding: 2px; margin-right: 5px;">Dr</div> <div style="margin-left: 10px;">Divisor (floating-point data, 32 bits)</div> </div> <hr style="width: 100%; border: 0.5px solid black;"/> <div style="display: flex; align-items: center;"> <div style="border: 1px solid black; padding: 2px; margin-right: 5px;">R+1</div> <div style="border: 1px solid black; padding: 2px; margin-right: 5px;">R</div> <div style="margin-left: 10px;">Result (floating-point data, 32 bits)</div> </div>

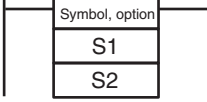
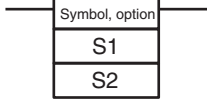
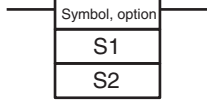
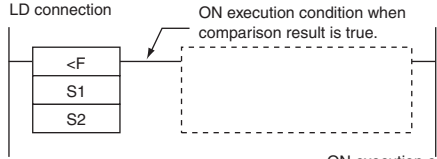
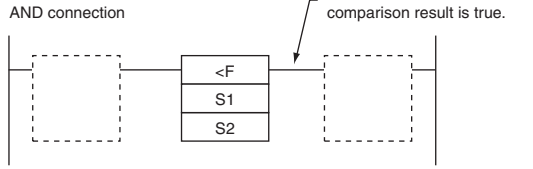
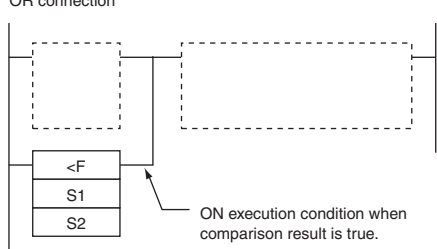
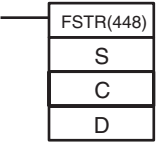
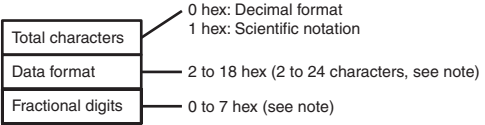
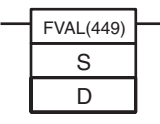
Instruction	Mnemonic	Variations	Symbol/Operand	Function
FLOATING SYMBOL COMPARISON	LD, AND, or OR + =F, <>F, <F, <=F, >F, or >=F	---	<p>Using LD:</p>  <p>Using AND:</p>  <p>Using OR:</p>  <p>S1: Comparison data 1 S2: Comparison data 2</p>	<p>Compares the specified single-precision data (32 bits) or constants and creates an ON execution condition if the comparison result is true.</p> <p>LD connection</p>  <p>AND connection</p>  <p>OR connection</p> 
FLOATING-POINT TO ASCII	FSTR	@	 <p>S: 1st source word C: Control word D: Destination word</p>	<p>Converts the specified single-precision floating-point data (32-bit decimal-point or exponential format) to text string data (ASCII) and outputs the result to the destination word.</p> <p>C: First Control Word</p>  <p><b>Note</b> There are limits on the total number of characters and the number of fractional digits.</p>
ASCII TO FLOATING-POINT	FVAL	@	 <p>S: Source word D: 1st destination word</p>	<p>Converts the specified text string (ASCII) representation of single-precision floating-point data (decimal-point or exponential format) to 32-bit single-precision floating-point data and outputs the result to the destination words.</p>

### A-1-14 Table Data Processing Instructions

Instruction	Mnemonic	Variations	Symbol/Operand	Function
SWAP BYTES	SWAP	@	<div style="border: 1px solid black; padding: 5px; width: fit-content;">             SWAP(637)              N              R1           </div> <p>N: Number of words R1: 1st word in range</p>	<p>Switches the leftmost and rightmost bytes in all of the words in the range.</p> <p>Byte position is swapped.</p>
FRAME CHECKSUM	FCS	@	<div style="border: 1px solid black; padding: 5px; width: fit-content;">             FCS(180)              C              R1              D           </div> <p>C: First control word R1: First word in range D: First destination word</p>	<p>Calculates the FCS value for the specified range and outputs the result in ASCII.</p> <p>C: First control word</p> <p>W: Number of words/bytes in range &amp; 1 to &amp;65535 (decimal) or #0001 to #FFFF (hex)</p> <p>Starting byte (Valid only when bit 13 is 1.) 0: Leftmost byte 1: Rightmost byte</p> <p>Calculation units 0: Words 1: Bytes</p>



Instruction	Mnemonic	Variations	Symbol/Operand	Function																																		
TIME-PROPORTIONAL OUTPUT	TPO	---	<div style="border: 1px solid black; padding: 5px; width: fit-content;">             TPO (685)              S              C              R           </div> <p>S: Input word            C: 1st parameter word            R: Pulse output bit</p>	<p>Inputs the duty ratio or manipulated variable from the specified word, converts the duty ratio to a time-proportional output based on the specified parameters, and outputs the result from the specified output.</p> <p><b>C: First Parameter Word</b></p> <p>Bits 04 to 07 of C specify the input type, i.e., whether the input word contains an input duty ratio or manipulated variable. (Set these bits to 0 hex to specify a input duty ratio or to 1 hex to specify a manipulated variable.)</p> <p>The following diagram shows the locations of the parameter data.</p> <p><b>R: Pulse Output Bit</b></p> <p>Specifies the destination output bit for the pulse output.</p> <p>Normally, specify an output bit allocated to a Transistor Output Unit and connect a solid state relay to the Transistor Output Unit.</p>																																		
SCALING	SCL	@	<div style="border: 1px solid black; padding: 5px; width: fit-content;">             SCL(194)              S              P1              R           </div> <p>S: Source word            P1: 1st parameter word            R: Result word</p>	<p>Converts unsigned binary data into unsigned BCD data according to the specified linear function.</p> <p>Scaling is performed according to the linear function defined by points A and B.</p> <table border="1" style="margin-left: auto; margin-right: auto;"> <tr> <td>P</td> <td>Ad (BCD)</td> <td rowspan="2">Converted value</td> </tr> <tr> <td>P+1</td> <td>As (BIN)</td> </tr> <tr> <td>P+2</td> <td>Bd (BCD)</td> <td rowspan="2">Converted value</td> </tr> <tr> <td>P+3</td> <td>Bs (BIN)</td> </tr> </table> <p><b>P1: First Parameter Word</b></p> <div style="margin-left: 20px;"> <table border="1" style="width: 100%;"> <tr> <td style="text-align: center;">15</td> <td style="text-align: center;">0</td> </tr> <tr> <td colspan="2" style="text-align: center;">P1</td> </tr> <tr> <td colspan="2" style="text-align: center;">Scaled value for point A (Ar) 0000 to 9999 (4-digit BCD)</td> </tr> </table>   <table border="1" style="width: 100%;"> <tr> <td style="text-align: center;">15</td> <td style="text-align: center;">0</td> </tr> <tr> <td colspan="2" style="text-align: center;">P1+1</td> </tr> <tr> <td colspan="2" style="text-align: center;">Unscaled value for point A (As) 0000 to FFFF (binary)</td> </tr> </table>   <table border="1" style="width: 100%;"> <tr> <td style="text-align: center;">15</td> <td style="text-align: center;">0</td> </tr> <tr> <td colspan="2" style="text-align: center;">P1+2</td> </tr> <tr> <td colspan="2" style="text-align: center;">Scaled value for point B (Br) 0000 to 9999 (4-digit BCD)</td> </tr> </table>   <table border="1" style="width: 100%;"> <tr> <td style="text-align: center;">15</td> <td style="text-align: center;">0</td> </tr> <tr> <td colspan="2" style="text-align: center;">P1+3</td> </tr> <tr> <td colspan="2" style="text-align: center;">Unscaled value for point B (Bs) 0000 to FFFF (binary)</td> </tr> </table> </div>	P	Ad (BCD)	Converted value	P+1	As (BIN)	P+2	Bd (BCD)	Converted value	P+3	Bs (BIN)	15	0	P1		Scaled value for point A (Ar) 0000 to 9999 (4-digit BCD)		15	0	P1+1		Unscaled value for point A (As) 0000 to FFFF (binary)		15	0	P1+2		Scaled value for point B (Br) 0000 to 9999 (4-digit BCD)		15	0	P1+3		Unscaled value for point B (Bs) 0000 to FFFF (binary)	
P	Ad (BCD)	Converted value																																				
P+1	As (BIN)																																					
P+2	Bd (BCD)	Converted value																																				
P+3	Bs (BIN)																																					
15	0																																					
P1																																						
Scaled value for point A (Ar) 0000 to 9999 (4-digit BCD)																																						
15	0																																					
P1+1																																						
Unscaled value for point A (As) 0000 to FFFF (binary)																																						
15	0																																					
P1+2																																						
Scaled value for point B (Br) 0000 to 9999 (4-digit BCD)																																						
15	0																																					
P1+3																																						
Unscaled value for point B (Bs) 0000 to FFFF (binary)																																						

Instruction	Mnemonic	Variations	Symbol/Operand	Function													
SCALING 2	SCL2	@	<div style="border: 1px solid black; padding: 5px; width: fit-content;"> <table border="1" style="width: 100%; border-collapse: collapse;"> <tr><td style="text-align: center;">SCL2(486)</td></tr> <tr><td style="text-align: center;">S</td></tr> <tr><td style="text-align: center;">P1</td></tr> <tr><td style="text-align: center;">R</td></tr> </table> </div> <p>S: Source word P1: 1st parameter word R: Result word</p>	SCL2(486)	S	P1	R	<p>Converts signed binary data into signed BCD data according to the specified linear function. An offset can be input in defining the linear function.</p> <div style="display: flex; justify-content: space-around;"> <div style="text-align: center;"> <p><b>Positive Offset</b></p> </div> <div style="text-align: center;"> <p><b>Negative Offset</b></p> </div> </div> <div style="text-align: center; margin-top: 20px;"> <p><b>Offset of 0000</b></p> </div> <div style="margin-top: 20px;"> <table border="1" style="width: 100%; border-collapse: collapse;"> <tr><td style="width: 20px;">P1</td><td style="width: 50px; text-align: center;">Offset</td><td>(Signed binary)</td></tr> <tr><td>P1 + 1</td><td style="text-align: center;">ΔY</td><td>(Signed binary)</td></tr> <tr><td>P1 + 2</td><td style="text-align: center;">ΔX</td><td>(Signed BCD)</td></tr> </table> </div> <div style="margin-top: 20px;"> <p><b>P1: First Parameter Word</b></p> <div style="display: flex; flex-direction: column; align-items: center;"> <div style="display: flex; align-items: center; margin-bottom: 10px;"> <div style="border: 1px solid black; padding: 2px 5px;">P1</div> <div style="border: 1px solid black; padding: 2px 10px; margin-left: 5px;"> <div style="display: flex; justify-content: space-between; width: 100%;"> <span>15</span><span>0</span> </div> </div> </div> <div style="margin-left: 100px; margin-top: 5px;"> <p>Offset of linear function 8000 to 7FFF (signed binary)</p> </div> <div style="display: flex; align-items: center; margin-bottom: 10px;"> <div style="border: 1px solid black; padding: 2px 5px;">P1+1</div> <div style="border: 1px solid black; padding: 2px 10px; margin-left: 5px;"> <div style="display: flex; justify-content: space-between; width: 100%;"> <span>15</span><span>0</span> </div> </div> </div> <div style="margin-left: 100px; margin-top: 5px;"> <p>ΔX 8000 to 7FFF (signed binary)</p> </div> <div style="display: flex; align-items: center;"> <div style="border: 1px solid black; padding: 2px 5px;">P1+2</div> <div style="border: 1px solid black; padding: 2px 10px; margin-left: 5px;"> <div style="display: flex; justify-content: space-between; width: 100%;"> <span>15</span><span>0</span> </div> </div> </div> <div style="margin-left: 100px; margin-top: 5px;"> <p>ΔY 0000 to 9999 (BCD)</p> </div> </div> </div> <p><b>Note</b> P1 to P1+2 must be in the same area.</p>	P1	Offset	(Signed binary)	P1 + 1	ΔY	(Signed binary)	P1 + 2	ΔX	(Signed BCD)
SCL2(486)																	
S																	
P1																	
R																	
P1	Offset	(Signed binary)															
P1 + 1	ΔY	(Signed binary)															
P1 + 2	ΔX	(Signed BCD)															

Instruction	Mnemonic	Variations	Symbol/Operand	Function
SCALING 3	SCL3	@	<div style="border: 1px solid black; padding: 5px; width: fit-content;"> <p>SCL3(487)</p> <p>S</p> <p>P1</p> <p>R</p> </div> <p>S: Source word P1: 1st parameter word R: Result word</p>	<p>Converts signed BCD data into signed binary data according to the specified linear function. An offset can be input in defining the linear function.</p> <div style="display: flex; justify-content: space-around;"> <div style="text-align: center;"> <p><b>Positive Offset</b></p> </div> <div style="text-align: center;"> <p><b>Negative Offset</b></p> </div> </div> <div style="text-align: center; margin-top: 20px;"> <p><b>Offset of 0000</b></p> </div> <div style="margin-top: 20px;"> <p><b>P1: First Parameter Word</b></p> <div style="display: flex; flex-direction: column; align-items: center;"> <div style="display: flex; align-items: center; margin-bottom: 10px;"> <div style="text-align: center; margin-right: 10px;">P1</div> <div style="border: 1px solid black; padding: 2px 10px; position: relative;"> <span style="position: absolute; left: -10px; top: 50%; transform: translateY(-50%);">15</span> <span style="position: absolute; right: -10px; top: 50%; transform: translateY(-50%);">0</span> </div> </div> <div style="margin-bottom: 10px;"> <p>Offset of linear function 8000 to 7FFF (signed binary)</p> </div> <div style="display: flex; align-items: center; margin-bottom: 10px;"> <div style="text-align: center; margin-right: 10px;">P1+1</div> <div style="border: 1px solid black; padding: 2px 10px; position: relative;"> <span style="position: absolute; left: -10px; top: 50%; transform: translateY(-50%);">15</span> <span style="position: absolute; right: -10px; top: 50%; transform: translateY(-50%);">0</span> </div> </div> <div style="margin-bottom: 10px;"> <p>ΔX 0001 to 9999 (BCD)</p> </div> <div style="display: flex; align-items: center; margin-bottom: 10px;"> <div style="text-align: center; margin-right: 10px;">P1+2</div> <div style="border: 1px solid black; padding: 2px 10px; position: relative;"> <span style="position: absolute; left: -10px; top: 50%; transform: translateY(-50%);">15</span> <span style="position: absolute; right: -10px; top: 50%; transform: translateY(-50%);">0</span> </div> </div> <div style="margin-bottom: 10px;"> <p>ΔY 8000 to 7FFF (signed binary)</p> </div> <div style="display: flex; align-items: center; margin-bottom: 10px;"> <div style="text-align: center; margin-right: 10px;">P1+3</div> <div style="border: 1px solid black; padding: 2px 10px; position: relative;"> <span style="position: absolute; left: -10px; top: 50%; transform: translateY(-50%);">15</span> <span style="position: absolute; right: -10px; top: 50%; transform: translateY(-50%);">0</span> </div> </div> <div style="margin-bottom: 10px;"> <p>Maximum conversion 8000 to 7FFF (signed binary)</p> </div> <div style="display: flex; align-items: center;"> <div style="text-align: center; margin-right: 10px;">P1+4</div> <div style="border: 1px solid black; padding: 2px 10px; position: relative;"> <span style="position: absolute; left: -10px; top: 50%; transform: translateY(-50%);">15</span> <span style="position: absolute; right: -10px; top: 50%; transform: translateY(-50%);">0</span> </div> </div> <p>Minimum conversion 8000 to 7FFF (signed binary)</p> </div> <p><b>Note</b> P1 to P1+4 must be in the same area.</p> </div>



Instruction	Mnemonic	Variations	Symbol/Operand	Function
AVERAGE	AVG	---	<div style="border: 1px solid black; padding: 5px; width: fit-content;">             AVG(195)  <hr/>             S  <hr/>             N  <hr/>             R           </div> <p>S: Source word N: Number of cycles R: Result word</p>	<p>Calculates the average value of an input word for the specified number of cycles.</p>

### A-1-16 Subroutine Instructions

Instruction	Mnemonic	Variations	Symbol/Operand	Function
SUBROUTINE CALL	SBS	@	<div style="border: 1px solid black; padding: 5px; width: fit-content;">             SBS(091)  <hr/>             N           </div> <p>N: Subroutine number</p>	<p>Calls the subroutine with the specified subroutine number and executes that program.</p>
SUBROUTINE ENTRY	SBN	---	<div style="border: 1px solid black; padding: 5px; width: fit-content;">             SBN(092)  <hr/>             N           </div> <p>N: Subroutine number</p>	<p>Indicates the beginning of the subroutine program with the specified subroutine number.</p>
SUBROUTINE RETURN	RET	---	<div style="border: 1px solid black; padding: 5px; width: fit-content;">             RET(093)           </div>	<p>Indicates the end of a subroutine program.</p>

## A-1-17 Interrupt Control Instructions

Instruction	Mnemonic	Variations	Symbol/Operand	Function
SET INTERRUPT MASK	MSKS	@	<div style="border: 1px solid black; padding: 5px; width: fit-content; margin-bottom: 5px;">MSKS(690)</div> <div style="border: 1px solid black; padding: 5px; width: fit-content; margin-bottom: 5px;">N</div> <div style="border: 1px solid black; padding: 5px; width: fit-content; margin-bottom: 5px;">C</div> <p>N: Interrupt number C: Control data</p>	<p>Sets up interrupt processing for I/O interrupts or scheduled interrupts. Both I/O interrupt tasks and scheduled interrupt tasks are masked (disabled) when the PC is first turned on. MSKS(690) can be used to unmask or mask I/O interrupts and set the time intervals for scheduled interrupts.</p> <p>The diagram illustrates the function of the MSKS instruction. It shows two scenarios: 1) Masking/unmasking I/O interrupts: A vertical bar represents interrupt inputs 2 to 7. A bracket indicates that these inputs can be masked (1) or unmasked (0). 2) Setting scheduled interrupt time interval: A clock face is shown with a label 'Time interval' and the text 'Set scheduled interrupt time interval.'</p>
CLEAR INTERRUPT	CLI	@	<div style="border: 1px solid black; padding: 5px; width: fit-content; margin-bottom: 5px;">CLI(691)</div> <div style="border: 1px solid black; padding: 5px; width: fit-content; margin-bottom: 5px;">N</div> <div style="border: 1px solid black; padding: 5px; width: fit-content; margin-bottom: 5px;">C</div> <p>N: Interrupt number C: Control data</p>	<p>Clears or retains recorded interrupt inputs for I/O interrupts or sets the time to the first scheduled interrupt for scheduled interrupts.</p> <p>N = 102 to 107</p> <p>The diagram shows two cases for N = 102 to 107. In the first case, an 'Interrupt input n' pulse occurs, but the 'Internal status' remains low, labeled 'Recorded interrupt cleared'. In the second case, an 'Interrupt input n' pulse occurs, and the 'Internal status' goes high, labeled 'Recorded interrupt retained'.</p> <p>N = 4</p> <p>The diagram shows 'MSKS(690)' being set to 0. A horizontal line represents the 'Time to first scheduled interrupt'. A box labeled 'Execution of scheduled interrupt task.' starts at this time.</p>
DISABLE INTERRUPTS	DI	@	<div style="border: 1px solid black; padding: 5px; width: fit-content; margin-bottom: 5px;">DI(693)</div>	<p>Disables execution of all interrupt tasks.</p>
ENABLE INTERRUPTS	EI	---	<div style="border: 1px solid black; padding: 5px; width: fit-content; margin-bottom: 5px;">EI(694)</div>	<p>Enables execution of all interrupt tasks that were disabled with DI(693).</p> <p>The diagram shows a large rectangular frame representing the system. At the top, a box labeled 'DI' is shown with a vertical line extending downwards, labeled 'Disables execution of all interrupt tasks.' At the bottom, a box labeled 'EI' is shown with a vertical line extending upwards, labeled 'Enables execution of all disabled interrupt tasks.'</p>

## A-1-18 High-speed Counter/Pulse Output Instructions

Instruction	Mnemonic	Variations	Symbol/Operand	Function																										
MODE CONTROL	INI	@	<div style="border: 1px solid black; padding: 5px; width: fit-content;">             INI(880)              P              C              NV           </div> <p>P: Port specifier            C: Control data            NV: First word with new PV</p>	<p>INI(880) can be used to execute the following operations</p> <ul style="list-style-type: none"> <li>To start or stop comparison of a high-speed counter's PV to the comparison table registered with CTBL(882).</li> <li>To change the PV of the high-speed counter.</li> <li>To change the PV of the pulse output (origin fixed at 0).</li> <li>To stop pulse output.</li> </ul> <p>Example: Setting the Present Position as the Origin</p> <p>Execution condition</p> <p>P: Port Specifier</p> <table border="1"> <tr><td>0000 hex</td><td>Pulse output 0</td></tr> <tr><td>0001 hex</td><td>Pulse output 1</td></tr> <tr><td>0010 hex</td><td>High-speed counter 0</td></tr> <tr><td>0011 hex</td><td>High-speed counter 1</td></tr> <tr><td>0012 hex</td><td>High-speed counter 2</td></tr> <tr><td>0013 hex</td><td>High-speed counter 3</td></tr> <tr><td>0014 hex</td><td>High-speed counter 4</td></tr> <tr><td>0015 hex</td><td>High-speed counter 5</td></tr> <tr><td>1000 hex</td><td>PWM(891) output 0</td></tr> </table> <p>C: Control Data</p> <table border="1"> <tr><td>0000 hex</td><td>Starts comparison.</td></tr> <tr><td>0001 hex</td><td>Stops comparison.</td></tr> <tr><td>0002 hex</td><td>Changes the PV.</td></tr> <tr><td>0003 hex</td><td>Stops pulse output.</td></tr> </table> <p>NV: First Word with New PV</p> <p>If C is 0002 hex (i.e., when changing a PV), NV and NV+1 contain the new PV. Any values in NV and NV+1 are ignored when C is not 0002 hex.</p> <p>For Pulse Output or High-speed Counter Input: 0000 0000 to FFFF FFFF hex</p> <p>For Interrupt Input in Counter Mode: 0000 0000 to 0000 FFFF hex</p>	0000 hex	Pulse output 0	0001 hex	Pulse output 1	0010 hex	High-speed counter 0	0011 hex	High-speed counter 1	0012 hex	High-speed counter 2	0013 hex	High-speed counter 3	0014 hex	High-speed counter 4	0015 hex	High-speed counter 5	1000 hex	PWM(891) output 0	0000 hex	Starts comparison.	0001 hex	Stops comparison.	0002 hex	Changes the PV.	0003 hex	Stops pulse output.
0000 hex	Pulse output 0																													
0001 hex	Pulse output 1																													
0010 hex	High-speed counter 0																													
0011 hex	High-speed counter 1																													
0012 hex	High-speed counter 2																													
0013 hex	High-speed counter 3																													
0014 hex	High-speed counter 4																													
0015 hex	High-speed counter 5																													
1000 hex	PWM(891) output 0																													
0000 hex	Starts comparison.																													
0001 hex	Stops comparison.																													
0002 hex	Changes the PV.																													
0003 hex	Stops pulse output.																													

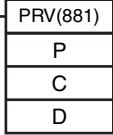
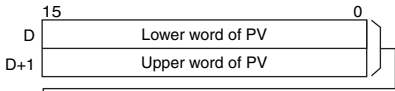
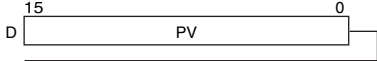
Instruction	Mnemonic	Variations	Symbol/Operand	Function																										
HIGH-SPEED COUNTER PV READ	PRV	@	 <p>P: Port specifier C: Control data D: First destination word</p>	<p>Reads the High-speed counter PV and pulse output PV. P: Port Specifier</p> <table border="1"> <tr><td>0000 hex</td><td>Pulse output 0</td></tr> <tr><td>0001 hex</td><td>Pulse output 1</td></tr> <tr><td>0010 hex</td><td>High-speed counter 0</td></tr> <tr><td>0011 hex</td><td>High-speed counter 1</td></tr> <tr><td>0012 hex</td><td>High-speed counter 2</td></tr> <tr><td>0013 hex</td><td>High-speed counter 3</td></tr> <tr><td>0014 hex</td><td>High-speed counter 4</td></tr> <tr><td>0015 hex</td><td>High-speed counter 5</td></tr> <tr><td>1000 hex</td><td>PWM(891) output 0</td></tr> </table> <p>C: Control Data</p> <table border="1"> <tr><td>0000 hex</td><td>Reads the PV.</td></tr> <tr><td>0001 hex</td><td>Reads status.</td></tr> <tr><td>0002 hex</td><td>Reads range comparison results.</td></tr> <tr><td>00□3 hex</td><td>P = 0000 or 0001: Reads the output frequency of pulse output 0 or pulse output 1. C = 0003 hex P = 0010: Reads the frequency of high-speed counter input 0. C = 0013 hex: 10-ms sampling method C = 0023 hex: 100-ms sampling method C = 0033 hex: 1-s sampling method</td></tr> </table> <p>D: First Destination Word</p>  <p>2-word PV Pulse output PV, high-speed counter input PV, high-speed counter input frequency for high-speed counter input 0</p>  <p>1-word PV Status, range comparison results</p>	0000 hex	Pulse output 0	0001 hex	Pulse output 1	0010 hex	High-speed counter 0	0011 hex	High-speed counter 1	0012 hex	High-speed counter 2	0013 hex	High-speed counter 3	0014 hex	High-speed counter 4	0015 hex	High-speed counter 5	1000 hex	PWM(891) output 0	0000 hex	Reads the PV.	0001 hex	Reads status.	0002 hex	Reads range comparison results.	00□3 hex	P = 0000 or 0001: Reads the output frequency of pulse output 0 or pulse output 1. C = 0003 hex P = 0010: Reads the frequency of high-speed counter input 0. C = 0013 hex: 10-ms sampling method C = 0023 hex: 100-ms sampling method C = 0033 hex: 1-s sampling method
0000 hex	Pulse output 0																													
0001 hex	Pulse output 1																													
0010 hex	High-speed counter 0																													
0011 hex	High-speed counter 1																													
0012 hex	High-speed counter 2																													
0013 hex	High-speed counter 3																													
0014 hex	High-speed counter 4																													
0015 hex	High-speed counter 5																													
1000 hex	PWM(891) output 0																													
0000 hex	Reads the PV.																													
0001 hex	Reads status.																													
0002 hex	Reads range comparison results.																													
00□3 hex	P = 0000 or 0001: Reads the output frequency of pulse output 0 or pulse output 1. C = 0003 hex P = 0010: Reads the frequency of high-speed counter input 0. C = 0013 hex: 10-ms sampling method C = 0023 hex: 100-ms sampling method C = 0033 hex: 1-s sampling method																													

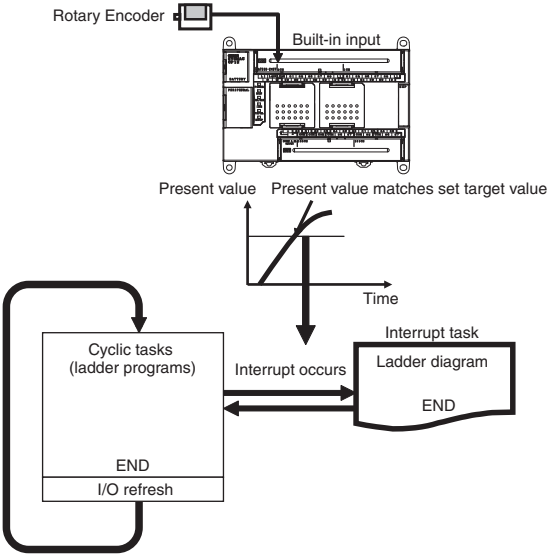
Instruction	Mnemonic	Variations	Symbol/Operand	Function																																																											
REGISTER COMPARISON TABLE	CTBL	@	<div style="border: 1px solid black; padding: 5px; width: fit-content;"> <table border="1"> <tr><td>CTBL(882)</td></tr> <tr><td>P</td></tr> <tr><td>C</td></tr> <tr><td>TB</td></tr> </table> </div> <p>P: Port specifier C: Control data TB: First comparison table word</p>	CTBL(882)	P	C	TB	<p>Registers a comparison table and performs comparisons for a PV of high-speed counter 0 to 5. An interrupt task between 0 to 15 will be executed when an execution condition is turned ON.</p>  <p>P: Port specifier</p> <table border="1" data-bbox="922 929 1264 1137"> <tr><td>0000 hex</td><td>High-speed counter 0</td></tr> <tr><td>0001 hex</td><td>High-speed counter 1</td></tr> <tr><td>0002 hex</td><td>High-speed counter 2</td></tr> <tr><td>0003 hex</td><td>High-speed counter 3</td></tr> <tr><td>0004 hex</td><td>High-speed counter 4</td></tr> <tr><td>0005 hex</td><td>High-speed counter 5</td></tr> </table> <p>C: Control data</p> <table border="1" data-bbox="922 1182 1417 1422"> <tr><td>0000 hex</td><td>Registers a target value comparison table and starts comparison.</td></tr> <tr><td>0001 hex</td><td>Registers a range comparison table and performs one comparison.</td></tr> <tr><td>0002 hex</td><td>Registers a target value comparison table. Comparison is started with INI(880).</td></tr> <tr><td>0003 hex</td><td>Registers a range comparison table. Comparison is started with INI(880).</td></tr> </table> <p>TB: First comparison table word</p> <p>TB is the first word of the comparison table. The structure of the comparison table depends on the type of comparison being performed.</p> <ul style="list-style-type: none"> <li>For target value comparison, the length of the comparison table is determined by the number of target values specified in TB. The table can be between 4 and 19 words long, as shown below.</li> </ul> <table border="1" data-bbox="922 1653 1474 1915"> <tr> <td>TB</td> <td>Number of target values</td> <td>0001 to 6 hex (1 to 6 target values)</td> </tr> <tr> <td>TB+1</td> <td>Lower word of target value 1</td> <td rowspan="3">00000000 to FFFFFFFF hex</td> </tr> <tr> <td>TB+2</td> <td>Upper word of target value 1</td> </tr> <tr> <td>TB+3</td> <td>Interrupt task number for target value 1</td> </tr> <tr> <td>TB+16</td> <td>Lower word of target value 6</td> <td rowspan="3">00000000 to FFFFFFFF hex</td> </tr> <tr> <td>TB+17</td> <td>Upper word of target value 6</td> </tr> <tr> <td>TB+18</td> <td>Interrupt task number for target value 6</td> </tr> </table> <p>Interrupt Task Number</p> <table border="1" data-bbox="970 1960 1305 2016"> <tr> <td>15</td><td>14</td><td>12</td><td>11</td><td>8</td><td>7</td><td>4</td><td>3</td><td>0</td> </tr> <tr> <td>0</td><td>0</td><td>0</td><td>0</td><td>0</td><td></td><td></td><td></td><td></td> </tr> </table> <p>Direction OFF: Incrementing, ON: Decrementing</p> <p>Interrupt task number 00 to 0F hex (0 to 15)</p>	0000 hex	High-speed counter 0	0001 hex	High-speed counter 1	0002 hex	High-speed counter 2	0003 hex	High-speed counter 3	0004 hex	High-speed counter 4	0005 hex	High-speed counter 5	0000 hex	Registers a target value comparison table and starts comparison.	0001 hex	Registers a range comparison table and performs one comparison.	0002 hex	Registers a target value comparison table. Comparison is started with INI(880).	0003 hex	Registers a range comparison table. Comparison is started with INI(880).	TB	Number of target values	0001 to 6 hex (1 to 6 target values)	TB+1	Lower word of target value 1	00000000 to FFFFFFFF hex	TB+2	Upper word of target value 1	TB+3	Interrupt task number for target value 1	TB+16	Lower word of target value 6	00000000 to FFFFFFFF hex	TB+17	Upper word of target value 6	TB+18	Interrupt task number for target value 6	15	14	12	11	8	7	4	3	0	0	0	0	0	0				
CTBL(882)																																																															
P																																																															
C																																																															
TB																																																															
0000 hex	High-speed counter 0																																																														
0001 hex	High-speed counter 1																																																														
0002 hex	High-speed counter 2																																																														
0003 hex	High-speed counter 3																																																														
0004 hex	High-speed counter 4																																																														
0005 hex	High-speed counter 5																																																														
0000 hex	Registers a target value comparison table and starts comparison.																																																														
0001 hex	Registers a range comparison table and performs one comparison.																																																														
0002 hex	Registers a target value comparison table. Comparison is started with INI(880).																																																														
0003 hex	Registers a range comparison table. Comparison is started with INI(880).																																																														
TB	Number of target values	0001 to 6 hex (1 to 6 target values)																																																													
TB+1	Lower word of target value 1	00000000 to FFFFFFFF hex																																																													
TB+2	Upper word of target value 1																																																														
TB+3	Interrupt task number for target value 1																																																														
TB+16	Lower word of target value 6	00000000 to FFFFFFFF hex																																																													
TB+17	Upper word of target value 6																																																														
TB+18	Interrupt task number for target value 6																																																														
15	14	12	11	8	7	4	3	0																																																							
0	0	0	0	0																																																											

Instruction	Mnemonic	Variations	Symbol/Operand	Function																														
REGISTER COMPARISON TABLE	CTBL	@	<div style="border: 1px solid black; padding: 5px; display: inline-block;"> <table border="1" style="border-collapse: collapse; text-align: center;"> <tr><td>CTBL(882)</td></tr> <tr><td>P</td></tr> <tr><td>C</td></tr> <tr><td>TB</td></tr> </table> </div> <p>P: Port specifier C: Control data TB: First comparison table word</p>	CTBL(882)	P	C	TB	<ul style="list-style-type: none"> <li>For range comparison, the comparison table always contains six ranges. The table is 30 words long, as shown below. If it is not necessary to set six ranges, set the interrupt task number to FFFF hex for all unused ranges.</li> </ul> <div style="display: flex; align-items: center;"> <table border="1" style="border-collapse: collapse; text-align: center; margin-right: 10px;"> <tr><td>15</td><td>0</td></tr> <tr><td>TB</td><td>Lower word of range 1 lower limit</td></tr> <tr><td>TB+1</td><td>Upper word of range 1 lower limit</td></tr> <tr><td>TB+2</td><td>Lower word of range 1 upper limit</td></tr> <tr><td>TB+3</td><td>Upper word of range 1 upper limit</td></tr> <tr><td colspan="2">Range 1 interrupt task number</td></tr> <tr><td colspan="2" style="text-align: center;">⋮</td></tr> <tr><td>TB+25</td><td>Lower word of range 6 lower limit</td></tr> <tr><td>TB+26</td><td>Upper word of range 6 lower limit</td></tr> <tr><td>TB+27</td><td>Lower word of range 6 upper limit</td></tr> <tr><td>TB+28</td><td>Upper word of range 6 upper limit</td></tr> <tr><td>TB+29</td><td>Range 6 interrupt task number</td></tr> </table> <div style="font-size: 2em;">}</div> <div style="margin-left: 10px;"> <p>0000 0000 to FFFF FFFF hex (See note.)</p> <p>0000 0000 to FFFF FFFF hex (See note.)</p> <p>0000 0000 to FFFF FFFF hex (See note.)</p> <p>0000 0000 to FFFF FFFF hex (See note.)</p> </div> </div> <p>Interrupt task number 0000 to 000F hex: Interrupt task number 0 to 15 AAAA hex: Do not execute interrupt task. FFFF hex: Ignore the settings for this range.</p> <p><b>Note</b> Always set the upper limit greater than or equal to the lower limit for any one range.</p>	15	0	TB	Lower word of range 1 lower limit	TB+1	Upper word of range 1 lower limit	TB+2	Lower word of range 1 upper limit	TB+3	Upper word of range 1 upper limit	Range 1 interrupt task number		⋮		TB+25	Lower word of range 6 lower limit	TB+26	Upper word of range 6 lower limit	TB+27	Lower word of range 6 upper limit	TB+28	Upper word of range 6 upper limit	TB+29	Range 6 interrupt task number		
CTBL(882)																																		
P																																		
C																																		
TB																																		
15	0																																	
TB	Lower word of range 1 lower limit																																	
TB+1	Upper word of range 1 lower limit																																	
TB+2	Lower word of range 1 upper limit																																	
TB+3	Upper word of range 1 upper limit																																	
Range 1 interrupt task number																																		
⋮																																		
TB+25	Lower word of range 6 lower limit																																	
TB+26	Upper word of range 6 lower limit																																	
TB+27	Lower word of range 6 upper limit																																	
TB+28	Upper word of range 6 upper limit																																	
TB+29	Range 6 interrupt task number																																	
SPEED OUTPUT	SPED	@	<div style="border: 1px solid black; padding: 5px; display: inline-block;"> <table border="1" style="border-collapse: collapse; text-align: center;"> <tr><td>SPED(855)</td></tr> <tr><td>P</td></tr> <tr><td>M</td></tr> <tr><td>F</td></tr> </table> </div> <p>P: Port specifier M: Output mode F: First pulse frequency word</p>	SPED(855)	P	M	F	<p>Sets the output pulse frequency for a specific port and starts pulse output without acceleration or deceleration.</p> <div style="text-align: center;"> <p>Pulse frequency</p> <p>Target frequency</p> <p>Time</p> <p>SPED(885) executed.</p> </div> <p>P: Port specifier</p> <table border="1" style="border-collapse: collapse; width: 100%;"> <tr> <td style="width: 50%;">0000 hex</td> <td>Pulse output 0</td> </tr> <tr> <td>0001 hex</td> <td>Pulse output 1</td> </tr> </table> <p>M: Output mode</p> <div style="display: flex; align-items: center;"> <table border="1" style="border-collapse: collapse; text-align: center; margin-right: 10px;"> <tr><td>15</td><td>12</td><td>11</td><td>8</td><td>7</td><td>4</td><td>3</td><td>0</td></tr> <tr><td colspan="8">M</td></tr> </table> <div style="margin-left: 10px;"> <p>Mode 0 hex: Continuous 1 hex: Independent</p> <p>Direction 0 hex: CW 1 hex: CCW</p> <p>Pulse output method 1 hex: Pulse + direction</p> <p>Always 0 hex.</p> </div> </div> <p>F: First pulse frequency word</p> <div style="display: flex; align-items: center;"> <table border="1" style="border-collapse: collapse; text-align: center; margin-right: 10px;"> <tr><td>15</td><td>0</td></tr> <tr><td>F</td><td>Lower word of target frequency</td></tr> <tr><td>F+1</td><td>Upper word of target frequency</td></tr> </table> <div style="font-size: 2em;">}</div> <div style="margin-left: 10px;"> <p>0 to 100000 Hz (0000 0000 to 0001 86A0 hex)</p> </div> </div> <p>The value of F and F+1 sets the pulse frequency in Hz.</p>	0000 hex	Pulse output 0	0001 hex	Pulse output 1	15	12	11	8	7	4	3	0	M								15	0	F	Lower word of target frequency	F+1	Upper word of target frequency
SPED(855)																																		
P																																		
M																																		
F																																		
0000 hex	Pulse output 0																																	
0001 hex	Pulse output 1																																	
15	12	11	8	7	4	3	0																											
M																																		
15	0																																	
F	Lower word of target frequency																																	
F+1	Upper word of target frequency																																	

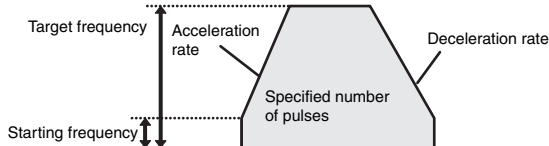
Instruction	Mnemonic	Variations	Symbol/Operand	Function																													
SET PULSES	PULS	@	<div style="border: 1px solid black; padding: 5px; width: fit-content;"> <table border="1" style="width: 100%; border-collapse: collapse;"> <tr><td style="text-align: center;">PULS(886)</td></tr> <tr><td style="text-align: center;">P</td></tr> <tr><td style="text-align: center;">T</td></tr> <tr><td style="text-align: center;">N</td></tr> </table> </div> <p>P: Port specifier T: Pulse type N: Number of pulses</p>	PULS(886)	P	T	N	<p>Sets the number of output pulses. Actual output of the pulses is started later in the program using SPED(885) or ACC(888) in independent mode.</p> <p>P: Port specifier</p> <table border="1" style="width: 100%; border-collapse: collapse;"> <tr><td style="width: 50%;">0000 hex</td><td>Pulse output 0</td></tr> <tr><td>0001 hex</td><td>Pulse output 1</td></tr> </table> <p>T: Pulse type</p> <table border="1" style="width: 100%; border-collapse: collapse;"> <tr><td style="width: 50%;">0000 hex</td><td>Relative</td></tr> <tr><td>0001 hex</td><td>Absolute</td></tr> </table> <p>N: Number of pulses</p> <div style="border: 1px solid black; padding: 5px; width: fit-content;"> <table style="width: 100%; border-collapse: collapse;"> <tr> <td style="width: 50%; text-align: right;">15</td> <td style="width: 50%; text-align: left;">0</td> </tr> <tr> <td style="text-align: right;">N</td> <td style="text-align: left;">Lower word with number of pulses</td> </tr> <tr> <td style="text-align: right;">N+1</td> <td style="text-align: left;">Upper word with number of pulses</td> </tr> </table> </div> <p>Relative pulse output: 0 to 2, 147, 483, 647, (0000 0000 to 7FFF FFFF hex)</p> <p>Absolute pulse output: -2, 147, 483, 648 to 2, 147, 483, 647, (8000 0000 to 7FFF FFFF hex)</p>	0000 hex	Pulse output 0	0001 hex	Pulse output 1	0000 hex	Relative	0001 hex	Absolute	15	0	N	Lower word with number of pulses	N+1	Upper word with number of pulses											
PULS(886)																																	
P																																	
T																																	
N																																	
0000 hex	Pulse output 0																																
0001 hex	Pulse output 1																																
0000 hex	Relative																																
0001 hex	Absolute																																
15	0																																
N	Lower word with number of pulses																																
N+1	Upper word with number of pulses																																
PULSE OUTPUT	PLS2	@	<div style="border: 1px solid black; padding: 5px; width: fit-content;"> <table border="1" style="width: 100%; border-collapse: collapse;"> <tr><td style="text-align: center;">PLS2(887)</td></tr> <tr><td style="text-align: center;">P</td></tr> <tr><td style="text-align: center;">M</td></tr> <tr><td style="text-align: center;">S</td></tr> <tr><td style="text-align: center;">F</td></tr> </table> </div> <p>P: Port specifier M: Output mode S: First word of settings table F: First word of starting frequency</p>	PLS2(887)	P	M	S	F	<p>Performs trapezoidal positioning control as the following time chart. Sets the target frequency, starting frequency, acceleration and deceleration rate and direction.</p>  <p>P: Port Specifier</p> <table border="1" style="width: 100%; border-collapse: collapse;"> <tr><td style="width: 50%;">0000 hex</td><td>Pulse output 0</td></tr> <tr><td>0001 hex</td><td>Pulse output 1</td></tr> </table> <p>M: Output Mode</p> <div style="border: 1px solid black; padding: 5px; width: fit-content;"> <table style="width: 100%; border-collapse: collapse;"> <tr> <td style="width: 50%; text-align: right;">15</td> <td style="width: 50%; text-align: left;">0</td> </tr> <tr> <td style="text-align: right;">12 11</td> <td style="text-align: left;">8 7</td> </tr> <tr> <td style="text-align: right;">4 3</td> <td style="text-align: left;">0</td> </tr> </table> <p>M</p> <p>Relative/absolute specifier 0 hex: Relative pulses 1 hex: Absolute pulses</p> <p>Direction 0 hex: CW 1 hex: CCW</p> <p>Pulse output method 1 hex: Pulse + direction</p> <p>Always 0 hex.</p> </div> <p>S: First Word of Settings Table</p> <div style="border: 1px solid black; padding: 5px; width: fit-content;"> <table style="width: 100%; border-collapse: collapse;"> <tr> <td style="width: 50%; text-align: right;">15</td> <td style="width: 50%; text-align: left;">0</td> </tr> <tr> <td style="text-align: right;">S1</td> <td style="text-align: left;">Acceleration rate</td> </tr> <tr> <td style="text-align: right;">S1+1</td> <td style="text-align: left;">Deceleration rate</td> </tr> </table> <p>1 to 65535 Hz (#0001 to FFFF)</p> <p>Specify the increase or decrease in the frequency per pulse control period (4 ms).</p> <table style="width: 100%; border-collapse: collapse;"> <tr> <td style="width: 50%; text-align: right;">S1+2</td> <td style="width: 50%; text-align: left;">Lower word with target frequency</td> </tr> <tr> <td style="width: 50%; text-align: right;">S1+3</td> <td style="width: 50%; text-align: left;">Upper word with target frequency</td> </tr> </table> <p>1 to 100,000 Hz (0000 0000 to 0001 86A0 hex)</p> <p>Specify the frequency after acceleration/deceleration in Hz.</p> <table style="width: 100%; border-collapse: collapse;"> <tr> <td style="width: 50%; text-align: right;">S1+4</td> <td style="width: 50%; text-align: left;">Lower word with number of output pulses</td> </tr> <tr> <td style="width: 50%; text-align: right;">S1+5</td> <td style="width: 50%; text-align: left;">Upper word with number of output pulses</td> </tr> </table> <p>Relative pulse output: 0 to 2, 147, 483, 647 (0000 0000 to 7FFF FFFF hex)</p> <p>Absolute pulse output: -2, 147, 483, 648 to 2, 147, 483, 647 (8000 0000 to 7FFF FFFF hex)</p> </div>	0000 hex	Pulse output 0	0001 hex	Pulse output 1	15	0	12 11	8 7	4 3	0	15	0	S1	Acceleration rate	S1+1	Deceleration rate	S1+2	Lower word with target frequency	S1+3	Upper word with target frequency	S1+4	Lower word with number of output pulses	S1+5	Upper word with number of output pulses
PLS2(887)																																	
P																																	
M																																	
S																																	
F																																	
0000 hex	Pulse output 0																																
0001 hex	Pulse output 1																																
15	0																																
12 11	8 7																																
4 3	0																																
15	0																																
S1	Acceleration rate																																
S1+1	Deceleration rate																																
S1+2	Lower word with target frequency																																
S1+3	Upper word with target frequency																																
S1+4	Lower word with number of output pulses																																
S1+5	Upper word with number of output pulses																																

Instruction	Mnemonic	Variations	Symbol/Operand	Function																										
PULSE OUTPUT	PLS2	@	<table border="1"> <tr><td>PLS2(887)</td></tr> <tr><td>P</td></tr> <tr><td>M</td></tr> <tr><td>S</td></tr> <tr><td>F</td></tr> </table> <p>P: Port specifier M: Output mode S: First word of settings table F: First word of starting frequency</p>	PLS2(887)	P	M	S	F	<p>F: First Word of Starting Frequency</p> <p>The starting frequency is given in F and F+1.</p> <table border="1"> <tr> <td>15</td> <td>0</td> </tr> <tr> <td>F</td> <td>Lower word with starting frequency</td> </tr> <tr> <td>F+1</td> <td>Upper word with starting frequency</td> </tr> </table> <p>0 to 100000 Hz (0000 0000 to 0001 86A0 hex)</p> <p>Specify the starting frequency in Hz.</p>	15	0	F	Lower word with starting frequency	F+1	Upper word with starting frequency															
PLS2(887)																														
P																														
M																														
S																														
F																														
15	0																													
F	Lower word with starting frequency																													
F+1	Upper word with starting frequency																													
ACCELERATION CONTROL	ACC	@	<table border="1"> <tr><td>ACC(888)</td></tr> <tr><td>P</td></tr> <tr><td>M</td></tr> <tr><td>S</td></tr> </table> <p>P: Port specifier M: Output mode S: First word of settings table</p>	ACC(888)	P	M	S	<p>Outputs pulses to the specified output port at the specified frequency using the specified acceleration and deceleration rate.</p> <p>P: Port Specifier</p> <table border="1"> <tr><td>0000 hex</td><td>Pulse output 0</td></tr> <tr><td>0001 hex</td><td>Pulse output 1</td></tr> </table> <p>M: Output Mode</p> <table border="1"> <tr> <td>15</td> <td>12 11</td> <td>8 7</td> <td>4 3</td> <td>0</td> </tr> <tr> <td colspan="5">M</td> </tr> </table> <p>Mode 0 hex: Continuous mode 1 hex: Independent mode</p> <p>Direction 0 hex: CW 1 hex: CCW</p> <p>Pulse output method 1 hex: Pulse + direction</p> <p>Always 0 hex.</p> <p>S: First Word of Settings Table</p> <table border="1"> <tr> <td>15</td> <td>0</td> </tr> <tr> <td>S</td> <td>Acceleration/deceleration rate</td> </tr> </table> <p>1 to 65535 Hz (#0001 to FFFF)</p> <p>Specify the increase or decrease in the frequency per pulse control period (4 ms).</p> <table border="1"> <tr> <td>S+1</td> <td>Lower word with target frequency</td> </tr> <tr> <td>S+2</td> <td>Upper word with target frequency</td> </tr> </table> <p>0 to 100000 Hz (0000 0000 to 0001 86A0 hex)</p> <p>Specify the frequency after acceleration or deceleration in Hz.</p>	0000 hex	Pulse output 0	0001 hex	Pulse output 1	15	12 11	8 7	4 3	0	M					15	0	S	Acceleration/deceleration rate	S+1	Lower word with target frequency	S+2	Upper word with target frequency
ACC(888)																														
P																														
M																														
S																														
0000 hex	Pulse output 0																													
0001 hex	Pulse output 1																													
15	12 11	8 7	4 3	0																										
M																														
15	0																													
S	Acceleration/deceleration rate																													
S+1	Lower word with target frequency																													
S+2	Upper word with target frequency																													

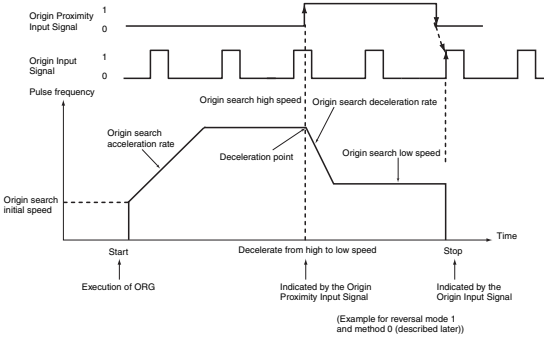
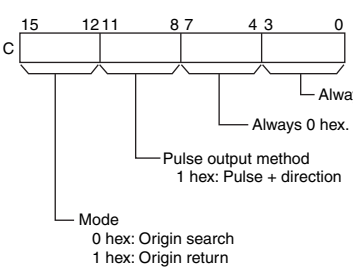

Instruction	Mnemonic	Variations	Symbol/Operand	Function											
ORIGIN SEARCH	ORG	@	<div style="border: 1px solid black; padding: 5px; width: fit-content;"> <table border="1" style="width: 100%; border-collapse: collapse;"> <tr><td style="text-align: center;">ORG(889)</td></tr> <tr><td style="text-align: center;">P</td></tr> <tr><td style="text-align: center;">C</td></tr> </table> </div> <p>P: Port specifier C: Control data</p>	ORG(889)	P	C	<p>Performs an origin search or origin return operation.</p>  <p>The following parameters must be set in the PLC Setup before ORG(889) can be executed.</p> <table border="1" style="width: 100%; border-collapse: collapse;"> <thead> <tr> <th style="width: 50%;">Origin search</th> <th style="width: 50%;">Origin return</th> </tr> </thead> <tbody> <tr> <td> <ul style="list-style-type: none"> <li>• Origin Search Function Enable/Disable</li> <li>• Origin Search Operating Mode</li> <li>• Origin Search Operation Setting</li> <li>• Origin Detection Method</li> <li>• Origin Search Direction Setting</li> <li>• Origin Search/Return Initial Speed</li> <li>• Origin Search High Speed</li> <li>• Origin Search Proximity Speed</li> <li>• Origin Compensation</li> <li>• Origin Search Acceleration Rate</li> <li>• Origin Search Deceleration Rate</li> <li>• Limit Input Signal Type</li> <li>• Origin Proximity Input Signal Type</li> <li>• Origin Input Signal Type</li> <li>• Positioning Monitor Time</li> </ul> </td> <td> <ul style="list-style-type: none"> <li>• Origin Search/Return Initial Speed</li> <li>• Origin Return Target Speed</li> <li>• Origin Return Acceleration Rate</li> <li>• Origin Return Deceleration Rate</li> </ul> </td> </tr> </tbody> </table> <p>P: Port Specifier</p> <table border="1" style="width: 100%; border-collapse: collapse;"> <tr> <td style="width: 20%;">0000 hex</td> <td>Pulse output 0</td> </tr> <tr> <td>0001 hex</td> <td>Pulse output 1</td> </tr> </table> <p>C: Control Data</p>  <p>Mode 0 hex: Origin search 1 hex: Origin return</p>	Origin search	Origin return	<ul style="list-style-type: none"> <li>• Origin Search Function Enable/Disable</li> <li>• Origin Search Operating Mode</li> <li>• Origin Search Operation Setting</li> <li>• Origin Detection Method</li> <li>• Origin Search Direction Setting</li> <li>• Origin Search/Return Initial Speed</li> <li>• Origin Search High Speed</li> <li>• Origin Search Proximity Speed</li> <li>• Origin Compensation</li> <li>• Origin Search Acceleration Rate</li> <li>• Origin Search Deceleration Rate</li> <li>• Limit Input Signal Type</li> <li>• Origin Proximity Input Signal Type</li> <li>• Origin Input Signal Type</li> <li>• Positioning Monitor Time</li> </ul>	<ul style="list-style-type: none"> <li>• Origin Search/Return Initial Speed</li> <li>• Origin Return Target Speed</li> <li>• Origin Return Acceleration Rate</li> <li>• Origin Return Deceleration Rate</li> </ul>	0000 hex	Pulse output 0	0001 hex	Pulse output 1
ORG(889)															
P															
C															
Origin search	Origin return														
<ul style="list-style-type: none"> <li>• Origin Search Function Enable/Disable</li> <li>• Origin Search Operating Mode</li> <li>• Origin Search Operation Setting</li> <li>• Origin Detection Method</li> <li>• Origin Search Direction Setting</li> <li>• Origin Search/Return Initial Speed</li> <li>• Origin Search High Speed</li> <li>• Origin Search Proximity Speed</li> <li>• Origin Compensation</li> <li>• Origin Search Acceleration Rate</li> <li>• Origin Search Deceleration Rate</li> <li>• Limit Input Signal Type</li> <li>• Origin Proximity Input Signal Type</li> <li>• Origin Input Signal Type</li> <li>• Positioning Monitor Time</li> </ul>	<ul style="list-style-type: none"> <li>• Origin Search/Return Initial Speed</li> <li>• Origin Return Target Speed</li> <li>• Origin Return Acceleration Rate</li> <li>• Origin Return Deceleration Rate</li> </ul>														
0000 hex	Pulse output 0														
0001 hex	Pulse output 1														

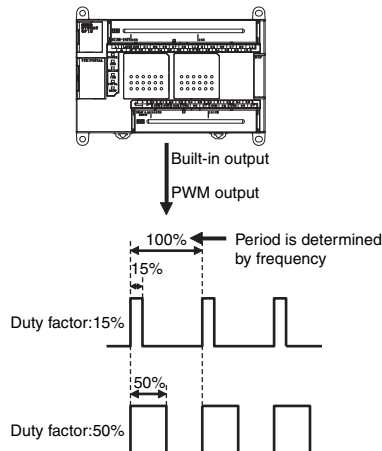
Instruction	Mnemonic	Variations	Symbol/Operand	Function								
PULSE WITH VARIABLE DUTY FACTOR	PWM	@	<div style="border: 1px solid black; padding: 5px; width: fit-content;"> <table border="1" style="width: 100%; border-collapse: collapse;"> <tr><td style="text-align: center;">PWM</td></tr> <tr><td style="text-align: center;">P</td></tr> <tr><td style="text-align: center;">F</td></tr> <tr><td style="text-align: center;">D</td></tr> </table> </div> <p>P: Port specifier F: Frequency D: Duty factor</p>	PWM	P	F	D	<p>Outputs pulses with the specified duty factor from the specified port.</p>  <p>Duty factor:15%</p> <p>Duty factor:50%</p> <p>P: Port Specifier</p> <table border="1" style="width: 100%; border-collapse: collapse;"> <tr> <td style="width: 20%; text-align: center;">1000 hex</td> <td>PWM output 0 (duty factor: in increments of 1%, frequency 0.1 Hz)</td> </tr> <tr> <td style="text-align: center;">1100 hex</td> <td>PWM output 0 (duty factor: in increments of 1%, frequency 1 Hz)</td> </tr> </table> <p>F: Frequency F specifies the frequency of the PWM output between 2.0 and 6,553.5 Hz (0.1 Hz units, 0014 to FFFF hex), or between 2 and 32,000 Hz (2 Hz units, 0002 to 7D00 hex).</p> <p>D: Duty Factor D specifies the duty factor of the PWM output, i.e., the percentage of time that the output is ON.</p>	1000 hex	PWM output 0 (duty factor: in increments of 1%, frequency 0.1 Hz)	1100 hex	PWM output 0 (duty factor: in increments of 1%, frequency 1 Hz)
PWM												
P												
F												
D												
1000 hex	PWM output 0 (duty factor: in increments of 1%, frequency 0.1 Hz)											
1100 hex	PWM output 0 (duty factor: in increments of 1%, frequency 1 Hz)											



## A-1-19 Step Instructions

Instruction	Mnemonic	Variations	Symbol/Operand	Function			
STEP DEFINE	STEP	---	<p>When defining the beginning of a step, a control bit is specified as follows:</p> <div style="border: 1px solid black; padding: 5px; width: fit-content;"> <table border="1" style="width: 100%; border-collapse: collapse;"> <tr><td style="text-align: center;">STEP(008)</td></tr> <tr><td style="text-align: center;">B</td></tr> </table> </div> <p>B: Bit</p> <p>When defining the end of a step, a control bit is not specified as follows:</p> <div style="border: 1px solid black; padding: 5px; width: fit-content;"> <table border="1" style="width: 100%; border-collapse: collapse;"> <tr><td style="text-align: center;">STEP(008)</td></tr> </table> </div>	STEP(008)	B	STEP(008)	<p>STEP(008) functions in following 2 ways, depending on its position and whether or not a control bit has been specified.</p> <p>(1) Starts a specific step.</p> <p>(2) Ends the step programming area (i.e., step execution).</p>
STEP(008)							
B							
STEP(008)							
STEP START	SNXT	---	<div style="border: 1px solid black; padding: 5px; width: fit-content;"> <table border="1" style="width: 100%; border-collapse: collapse;"> <tr><td style="text-align: center;">SNXT(009)</td></tr> <tr><td style="text-align: center;">B</td></tr> </table> </div> <p>B: Bit</p>	SNXT(009)	B	<p>SNXT(009) is used in the following three ways:</p> <p>(1) To start step programming execution.</p> <p>(2) To proceed to the next step control bit.</p> <p>(3) To end step programming execution.</p>	
SNXT(009)							
B							

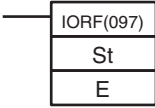
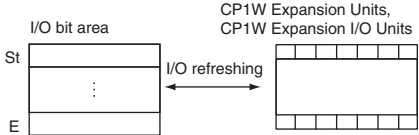
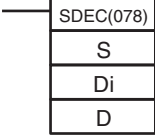
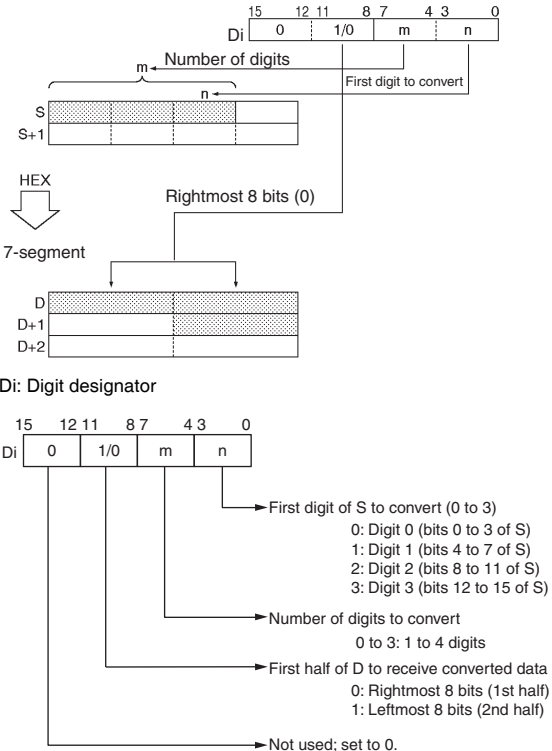
## A-1-20 Basic I/O Unit Instructions

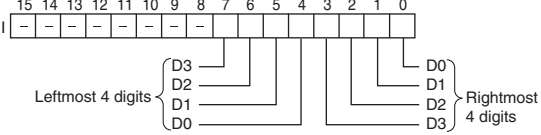
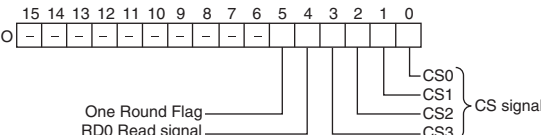
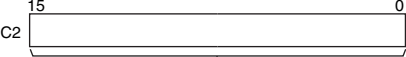
Instruction	Mnemonic	Variations	Symbol/Operand	Function
I/O REFRESH	IORF	@	 <p>St: Starting word E: End word</p>	<p>Refreshes the specified I/O words.</p> 
7-SEGMENT DECODER	SDEC	@	 <p>S: Source word Di: Digit designator D: 1st destination word</p>	<p>Converts the hexadecimal contents of the designated digit(s) into 8-bit, 7-segment display code and places it into the upper or lower 8-bits of the specified destination words.</p>  <p>Di: Digit designator</p> <p>15 12 11 8 7 4 3 0 Di 0 1/0 m n</p> <ul style="list-style-type: none"> <li>First digit of S to convert (0 to 3)             <ul style="list-style-type: none"> <li>0: Digit 0 (bits 0 to 3 of S)</li> <li>1: Digit 1 (bits 4 to 7 of S)</li> <li>2: Digit 2 (bits 8 to 11 of S)</li> <li>3: Digit 3 (bits 12 to 15 of S)</li> </ul> </li> <li>Number of digits to convert             <ul style="list-style-type: none"> <li>0 to 3: 1 to 4 digits</li> </ul> </li> <li>First half of D to receive converted data             <ul style="list-style-type: none"> <li>0: Rightmost 8 bits (1st half)</li> <li>1: Leftmost 8 bits (2nd half)</li> </ul> </li> <li>Not used; set to 0.</li> </ul>

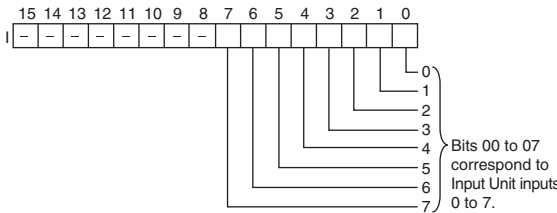
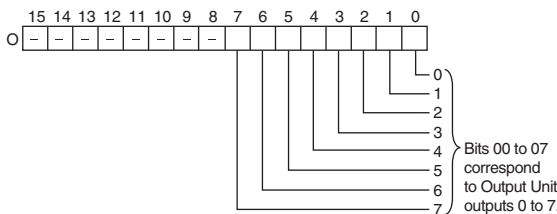
Instruction	Mnemonic	Variations	Symbol/Operand	Function						
DIGITAL SWITCH INPUT	DSW	---	<div style="border: 1px solid black; padding: 5px; width: fit-content;"> <table border="1" style="width: 100%; text-align: center;"> <tr><td>DSW (210)</td></tr> <tr><td>I</td></tr> <tr><td>O</td></tr> <tr><td>D</td></tr> <tr><td>C1</td></tr> <tr><td>C2</td></tr> </table> </div> <p>I: Data input word (D0 to D3)  O: Output word  D: 1st result word  C1: Number of digits  C2: System word</p>	DSW (210)	I	O	D	C1	C2	<p>Reads the value set on an external digital switch (or thumbwheel switch) connected to an Input Unit or Output Unit and stores the 4-digit or 8-digit BCD data in the specified words.</p> <p><b>I: Input Word (Data Line D0 to D3 Inputs)</b></p> <p>Specify the input word allocated to the Input Unit and connect the digital switch's D0 to D3 data lines to the Input Unit as shown in the following diagram.</p>  <p><b>O: Output Word (CS/RD Control Signal Outputs)</b></p> <p>Specify the output word allocated to the Output Unit and connect the digital switch's control signals (CS and RD signals) to the Output Unit as shown in the following diagram.</p>  <p><b>C1: Number of Digits</b></p> <p>Specifies the number of digits that will be read from the external digital switch. Set C1 to 0000 hex to read 4 digits or 0001 hex to read 8 digits.</p> <p><b>C2: System Word</b></p> <p>Specifies a work word used by the instruction. This word cannot be used in any other application.</p>  <p style="text-align: center;">System word (Cannot be accessed by the user.)</p>
DSW (210)										
I										
O										
D										
C1										
C2										

Instruction	Mnemonic	Variations	Symbol/Operand	Function
MATRIX INPUT	MTR	---	<div style="border: 1px solid black; padding: 5px; width: fit-content;"> MTR (213)  <hr/> I  <hr/> O  <hr/> D  <hr/> C </div> <p>I: Data input word  O: Output word  D: 1st destination word  C: System word</p>	<p>Inputs up to 64 signals from an 8 × 8 matrix connected to an Input Unit and Output Unit (using 8 input points and 8 output points) and stores that 64-bit data in the 4 destination words.</p> <p><b>I: Input Word</b></p> <p>Specify the input word allocated to the Input Unit and connect the 8 input signal lines to the Input Unit as shown in the following diagram.</p>  <p><b>O: Output Word (Selection Signal Outputs)</b></p> <p>Specify the output word allocated to the Output Unit and connect the 8 selection signals to the Output Unit as shown in the following diagram.</p>  <p><b>C: System Word</b></p> <p>Specifies a work word used by the instruction. This word cannot be used in any other application.</p>  <p style="text-align: center;">System word (Cannot be accessed by the user.)</p>

Instruction	Mnemonic	Variations	Symbol/Operand	Function																										
7-SEGMENT DISPLAY OUTPUT	7SEG	---	<div style="border: 1px solid black; padding: 5px; width: fit-content;"> <div style="border: 1px solid black; padding: 2px;">7SEG (214)</div> <div style="border: 1px solid black; padding: 2px; margin-bottom: 2px;">S</div> <div style="border: 1px solid black; padding: 2px; margin-bottom: 2px;">O</div> <div style="border: 1px solid black; padding: 2px; margin-bottom: 2px;">C</div> <div style="border: 1px solid black; padding: 2px;">D</div> </div> <p>S: 1st source word O: Output word C: Control data D: System word</p>	<p>Converts the source data (either 4-digit or 8-digit BCD) to 7-segment display data, and outputs that data to the specified output word.</p> <p>O: Output Word (Data and Latch Outputs)</p> <p>Specify the output word allocated to the Output Unit and connect the 7-segment display to the Output Unit as shown in the following diagram.</p> <ul style="list-style-type: none"> <li>• Converting 4 digits                      </li> <li>• Converting 8 digits                      </li> </ul> <p>C: Control Data</p> <p>The value of C indicates the number of digits of source data and the logic for the Input and Output Units, as shown in the following table. (The logic refers to the transistor output's NPN or PNP logic.)</p> <table border="1" style="width: 100%; border-collapse: collapse;"> <thead> <tr> <th>Source data</th> <th>Display's data input logic</th> <th>Display's latch input logic</th> <th>C</th> </tr> </thead> <tbody> <tr> <td rowspan="4">4 digits (S)</td> <td rowspan="2">Same as Output Unit</td> <td>Same as Output Unit</td> <td>0000</td> </tr> <tr> <td>Different from Output Unit</td> <td>0001</td> </tr> <tr> <td rowspan="2">Different from Output Unit</td> <td>Same as Output Unit</td> <td>0002</td> </tr> <tr> <td>Different from Output Unit</td> <td>0003</td> </tr> <tr> <td rowspan="4">8 digits (S, S+1)</td> <td rowspan="2">Same as Output Unit</td> <td>Same as Output Unit</td> <td>0004</td> </tr> <tr> <td>Different from Output Unit</td> <td>0005</td> </tr> <tr> <td rowspan="2">Different from Output Unit</td> <td>Same as Output Unit</td> <td>0006</td> </tr> <tr> <td>Different from Output Unit</td> <td>0007</td> </tr> </tbody> </table> <p>D: System Word</p> <p>Specifies a work word used by the instruction. This word cannot be used in any other application.</p>	Source data	Display's data input logic	Display's latch input logic	C	4 digits (S)	Same as Output Unit	Same as Output Unit	0000	Different from Output Unit	0001	Different from Output Unit	Same as Output Unit	0002	Different from Output Unit	0003	8 digits (S, S+1)	Same as Output Unit	Same as Output Unit	0004	Different from Output Unit	0005	Different from Output Unit	Same as Output Unit	0006	Different from Output Unit	0007
Source data	Display's data input logic	Display's latch input logic	C																											
4 digits (S)	Same as Output Unit	Same as Output Unit	0000																											
		Different from Output Unit	0001																											
	Different from Output Unit	Same as Output Unit	0002																											
		Different from Output Unit	0003																											
8 digits (S, S+1)	Same as Output Unit	Same as Output Unit	0004																											
		Different from Output Unit	0005																											
	Different from Output Unit	Same as Output Unit	0006																											
		Different from Output Unit	0007																											

## A-1-21 Serial Communications Instructions

Instruction	Mnemonic	Variations	Symbol/Operand	Function																				
TRANSMIT	TXD	@	<div style="border: 1px solid black; padding: 5px; margin-bottom: 5px;"> <table style="width: 100%; border-collapse: collapse;"> <tr><td style="border: 1px solid black; padding: 2px;">TXD(236)</td></tr> <tr><td style="border: 1px solid black; padding: 2px;">S</td></tr> <tr><td style="border: 1px solid black; padding: 2px;">C</td></tr> <tr><td style="border: 1px solid black; padding: 2px;">N</td></tr> </table> </div> <p>S: 1st source word                      C: Control word                      N: Number of bytes                      0000 to 0100 hex                      (0 to 256 decimal)</p>	TXD(236)	S	C	N	<p>Outputs the specified number of bytes of data without conversion from the RS-232C port or built-in RS-485 port built into the CPU Unit or the serial Option Board according to the start code and end code specified for no-protocol mode in the PLC Setup.</p> <p>C: Control word</p> <div style="display: flex; align-items: flex-start;"> <div style="margin-right: 20px;"> <table style="border-collapse: collapse;"> <tr><td style="border: 1px solid black; padding: 2px;">15</td><td style="border: 1px solid black; padding: 2px;">12</td><td style="border: 1px solid black; padding: 2px;">11</td><td style="border: 1px solid black; padding: 2px;">8</td><td style="border: 1px solid black; padding: 2px;">7</td><td style="border: 1px solid black; padding: 2px;">4</td><td style="border: 1px solid black; padding: 2px;">3</td><td style="border: 1px solid black; padding: 2px;">0</td></tr> <tr><td colspan="8" style="border: none;">C</td></tr> </table> </div> <div> <p>Byte order                          0: Most significant bytes first                          1: Least significant bytes first</p> <p>RS and ER signal control                          0: No RS and ER signal control                          1: RS signal control                          2: ER signal control                          3: RS and ER signal control</p> <p>Serial port specifier                          1: CPU Unit's RS-232C port                          2: Serial Option Board/Built-in RS485 port</p> </div> </div>	15	12	11	8	7	4	3	0	C							
TXD(236)																								
S																								
C																								
N																								
15	12	11	8	7	4	3	0																	
C																								
RECEIVE	RXD	@	<div style="border: 1px solid black; padding: 5px; margin-bottom: 5px;"> <table style="width: 100%; border-collapse: collapse;"> <tr><td style="border: 1px solid black; padding: 2px;">RXD(235)</td></tr> <tr><td style="border: 1px solid black; padding: 2px;">D</td></tr> <tr><td style="border: 1px solid black; padding: 2px;">C</td></tr> <tr><td style="border: 1px solid black; padding: 2px;">N</td></tr> </table> </div> <p>D: 1st destination word                      C: Control word                      N: Number of bytes to store                      0000 to 0100 hex                      (0 to 256 decimal)</p>	RXD(235)	D	C	N	<p>Reads the specified number of bytes of data starting with the specified first word from the RS-232C port or built-in RS-485 port built into the CPU Unit or the serial Option Board according to the start code and end code specified for no-protocol mode in the PLC Setup.</p> <p>C: Control Word</p> <div style="display: flex; align-items: flex-start;"> <div style="margin-right: 20px;"> <table style="border-collapse: collapse;"> <tr><td style="border: 1px solid black; padding: 2px;">15</td><td style="border: 1px solid black; padding: 2px;">12</td><td style="border: 1px solid black; padding: 2px;">11</td><td style="border: 1px solid black; padding: 2px;">8</td><td style="border: 1px solid black; padding: 2px;">7</td><td style="border: 1px solid black; padding: 2px;">4</td><td style="border: 1px solid black; padding: 2px;">3</td><td style="border: 1px solid black; padding: 2px;">0</td></tr> <tr><td colspan="8" style="border: none;">C</td></tr> </table> </div> <div> <p>Byte order                          0 Hex: Most significant byte to least significant byte                          1 Hex: Least significant byte to most significant byte</p> <p>CS and DR signal monitoring                          0: No CS and DR signal monitoring                          1: CS signal monitoring                          2: DR signal monitoring                          3: CS and DR signal monitoring</p> <p>Serial port specifier                          1: CPU Unit's RS-232C port                          2: Serial Option Board/Built-in RS485 port</p> </div> </div>	15	12	11	8	7	4	3	0	C							
RXD(235)																								
D																								
C																								
N																								
15	12	11	8	7	4	3	0																	
C																								

## A-1-22 Clock Instructions

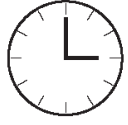
Instruction	Mnemonic	Variations	Symbol/Operand	Function
CALENDAR ADD	CADD	@	<div style="border: 1px solid black; padding: 5px; width: fit-content;"> CADD(730)  C  T  R </div> <p>C: 1st calendar word T: 1st time word R: 1st result word</p>	<p>Adds time to the calendar data in the specified words.</p> <div style="display: flex; flex-direction: column; align-items: center;"> <div style="display: flex; justify-content: space-between; width: 100px;"> <span>15</span><span>8 7</span><span>0</span> </div> <div style="border: 1px solid black; padding: 2px; margin: 2px;"> C    Minutes    Seconds  C+1    Day    Hour  C+2    Year    Month </div> <div style="margin: 5px 0;">+</div> <div style="display: flex; justify-content: space-between; width: 100px;"> <span>15</span><span>8 7</span><span>0</span> </div> <div style="border: 1px solid black; padding: 2px; margin: 2px;"> T    Minutes    Seconds  T+1    Hours </div> <div style="margin: 5px 0;">↓</div> <div style="display: flex; justify-content: space-between; width: 100px;"> <span>15</span><span>8 7</span><span>0</span> </div> <div style="border: 1px solid black; padding: 2px; margin: 2px;"> R    Minutes    Seconds  R+1    Day    Hour  R+2    Year    Month </div> </div>
CALENDAR SUBTRACT	CSUB	@	<div style="border: 1px solid black; padding: 5px; width: fit-content;"> CSUB(731)  C  T  R </div> <p>C: 1st calendar word T: 1st time word R: 1st result word</p>	<p>Subtracts time from the calendar data in the specified words.</p> <div style="display: flex; flex-direction: column; align-items: center;"> <div style="display: flex; justify-content: space-between; width: 100px;"> <span>15</span><span>8 7</span><span>0</span> </div> <div style="border: 1px solid black; padding: 2px; margin: 2px;"> C    Minutes    Seconds  C+1    Day    Hour  C+2    Year    Month </div> <div style="margin: 5px 0;">-</div> <div style="display: flex; justify-content: space-between; width: 100px;"> <span>15</span><span>8 7</span><span>0</span> </div> <div style="border: 1px solid black; padding: 2px; margin: 2px;"> T    Minutes    Seconds  T+1    Hours </div> <div style="margin: 5px 0;">↓</div> <div style="display: flex; justify-content: space-between; width: 100px;"> <span>15</span><span>8 7</span><span>0</span> </div> <div style="border: 1px solid black; padding: 2px; margin: 2px;"> R    Minutes    Seconds  R+1    Day    Hour  R+2    Year    Month </div> </div>
CLOCK ADJUSTMENT	DATE	@	<div style="border: 1px solid black; padding: 5px; width: fit-content;"> DATE(735)  S </div> <p>S: 1st source word</p>	<p>Changes the internal clock setting to the setting in the specified source words.</p> <div style="display: flex; align-items: center;"> <div style="border: 1px solid black; padding: 10px; margin-right: 20px;"> CPU Unit    Internal clock   </div> <div style="display: flex; flex-direction: column; align-items: center;"> <p>New setting ←</p> <div style="border: 1px solid black; padding: 2px; margin: 2px;"> S1    Minutes    Seconds  S+1    Day    Hour  S+2    Year    Month  S+3    00    Day of week </div> </div> </div>



## A-1-23 Failure Diagnosis Instructions

Instruction	Mnemonic	Variations	Symbol/Operand	Function			
FAILURE ALARM	FAL	@	<div style="border: 1px solid black; padding: 5px; width: fit-content;"> <table style="width: 100%; border-collapse: collapse;"> <tr><td style="text-align: center;">FAL(006)</td></tr> <tr><td style="text-align: center;">N</td></tr> <tr><td style="text-align: center;">S</td></tr> </table> </div> <p>N: FAL number S: 1st message word or error code to generate</p>	FAL(006)	N	S	<p>Generates or clears user-defined non-fatal errors. Non-fatal errors do not stop PC operation.</p> <p>Also generates non-fatal errors with the system.</p>
FAL(006)							
N							
S							
SEVERE FAILURE ALARM	FALS	---	<div style="border: 1px solid black; padding: 5px; width: fit-content;"> <table style="width: 100%; border-collapse: collapse;"> <tr><td style="text-align: center;">FALS(007)</td></tr> <tr><td style="text-align: center;">N</td></tr> <tr><td style="text-align: center;">S</td></tr> </table> </div> <p>N: FALS number S: 1st message word or error code to generate</p>	FALS(007)	N	S	<p>Generates user-defined fatal errors.</p> <p>Fatal errors stop PC operation.</p> <p>Also generates fatal errors with the system.</p>
FALS(007)							
N							
S							

## A-1-24 Other Instructions

Instruction	Mnemonic	Variations	Symbol/Operand	Function		
SET CARRY	STC	@	<div style="border: 1px solid black; padding: 5px; width: fit-content;"> <table style="width: 100%; border-collapse: collapse;"> <tr><td style="text-align: center;">STC(040)</td></tr> </table> </div>	STC(040)	Sets the Carry Flag (CY).	
STC(040)						
CLEAR CARRY	CLC	@	<div style="border: 1px solid black; padding: 5px; width: fit-content;"> <table style="width: 100%; border-collapse: collapse;"> <tr><td style="text-align: center;">CLC(041)</td></tr> </table> </div>	CLC(041)	Turns OFF the Carry Flag (CY).	
CLC(041)						
EXTEND MAXIMUM CYCLE TIME	WDT	@	<div style="border: 1px solid black; padding: 5px; width: fit-content;"> <table style="width: 100%; border-collapse: collapse;"> <tr><td style="text-align: center;">WDT(094)</td></tr> <tr><td style="text-align: center;">T</td></tr> </table> </div> <p>T: Timer setting</p>	WDT(094)	T	Extends the maximum cycle time, but only for the cycle in which this instruction is executed.
WDT(094)						
T						

# A-2 Auxiliary Area Allocations by Address

The following table lists the data provided in the Auxiliary Area in order of the addresses of the data.

## A-2-1 Read-only Words

Address		Name	Function	Settings	Status after mode change	Status at startup	Write timing	Related flags, settings
Words	Bits							
A0		10-ms Incrementing Free Running Timer	<p>This word contains the system timer used after the power is turned ON.</p> <p>A value of 0000 hex is set when the power is turned ON and this value is automatically incremented by 1 every 10 ms. The value returns to 0000 hex after reaching FFFF hex (655,350 ms), and then continues to be automatically incremented by 1 every 10 ms.</p> <p><b>Note</b> The timer will continue to be incremented when the operating mode is switched to RUN mode.</p> <p>Example: The interval can be counted between processing A and processing B without requiring timer instructions. This is achieved by calculating the difference between the value in A0 for processing A and the value in A0 for processing B. The interval is counted in 10 ms units.</p>		Retained	Cleared	Every 10 ms after power is turned ON	
A1		100-ms Incrementing Free Running Timer	<p>This word contains the system timer used after the power is turned ON.</p> <p>A value of 0000 hex is set when the power is turned ON and this value is automatically incremented by 1 every 100 ms. The value returns to 0000 hex after reaching FFFF hex (6,553,500 ms), and then continues to be automatically incremented by 1 every 100 ms.</p> <p><b>Note</b> The timer will continue to be incremented when the operating mode is switched to RUN mode.</p> <p>Example: The interval can be counted between processing A and processing B without requiring timer instructions. This is achieved by calculating the difference between the value in A0 for processing A and the value in A0 for processing B. The interval is counted in 100 ms units.</p>		Retained	Cleared	Every 100 ms after power is turned ON	
A99	00	UM Read Protection Status	Indicates whether all of the ladder programs in the PLC are read-protected.	<p>OFF: UM not read-protected</p> <p>ON: UM read-protected.</p>	Retained	Retained	When protection is set or cleared	

Address		Name	Function	Settings	Status after mode change	Status at startup	Write timing	Related flags, settings
Words	Bits							
A100 to A199		Error Log Area	<p>When an error has occurred, the error code, error contents, and error's time and date are stored in the Error Log Area. Information on the 20 most recent errors can be stored. Each error record occupies 5 words; the function of these 5 words is as follows:</p> <p>First word: Error code (bits 0 to 15)                      First word + 1: Error contents (bits 0 to 15)                      First word + 2: Minutes (upper byte), Seconds (lower byte)                      First word + 3: Day of month (upper byte), Hours (lower byte)                      First word + 4: Year (upper byte), Month (lower byte)</p> <p><b>Note 1</b> The data will be unstable if the capacitor becomes discharged.  <b>2</b> Errors generated by FAL(006) and FALS(007) will also be stored in this Error Log.  <b>3</b> The Error Log Area can be reset from the CX-Programmer.  <b>4</b> If the Error Log Area is full (20 records) and another error occurs, the oldest record in A100 to A104 will be cleared, the other 19 records are shifted down, and the new record is stored in A195 to A199.  <b>5</b> In an E□□(S)-type CPU Unit, the data will be for 1:01.01 on Sunday January 1, 2001.</p>	Error code Error contents: Address of Aux. Area word with details or 0000 hex if there is no related word. Seconds: 00 to 59, BCD Minutes: 00 to 59, BCD Hours: 00 to 23, BCD Day of month: 01 to 31, BCD Month: 01 to 12, BCD Year: 00 to 99, BCD	Retained	Retained	Refreshed when error occurs.	A500.14 A300 A400
A200	11	First Cycle Flag	ON for one cycle after PLC operation begins (after the mode is switched from PROGRAM to RUN or MONITOR, for example).	ON for the first cycle	ON	Cleared		
	12	Step Flag	ON for one cycle when step execution is started with STEP. This flag can be used for initialization processing at the beginning of a step.	ON for the first cycle after execution of STEP.	Cleared	Cleared		
	14	Task Started Flag	When a task switches from WAIT or INI to RUN status, this flag will be turned ON within the task for one cycle only. <b>Note</b> The only difference between this flag and A200.15 is that this flag also turns ON when the task switches from WAIT to RUN status.	ON: ON for first cycle (including transitions from WAIT and IN) OFF: Other	Cleared	Cleared		
	15	First Task Startup Flag	ON when a task is executed for the first time. This flag can be used to check whether the current task is being executed for the first time so that initialization processing can be performed if necessary.	ON: First execution OFF: Not executable or not being executed for the first time.	Cleared	Cleared		
A262 and A263		Maximum Cycle Time	These words contain the maximum cycle time since the start of PLC operation. The cycle time is recorded in 32-bit binary. The upper digits are in A263 and the lower digits are in A262.	0 to FFFFFFFF: 0 to 429,496,729.5 ms (0.1-ms units)	–	–		
A264 and A265		Present Cycle Time	These words contain the present cycle time. The cycle time is recorded in 32-bit binary. The upper digits are in A265 and the lower digits are in A264.	0 to FFFFFFFF: 0 to 429,496,729.5 ms (0.1-ms units)	–	–		

Address		Name	Function	Settings	Status after mode change	Status at startup	Write timing	Related flags, settings
Words	Bits							
A270 and A271		High-speed Counter 0 PV	Contains the PV of high-speed counter 0. A271 contains the upper 4 digits and A270 contains the lower 4 digits. <ul style="list-style-type: none"> <li>Cleared when operation starts.</li> </ul>			Cleared	<ul style="list-style-type: none"> <li>Refreshed each cycle during the overseeing processes.</li> <li>Refreshed when PRV instruction is executed to read the PV.</li> </ul>	
A272 and A273		High-speed Counter 1 PV	Contains the PV of high-speed counter 1. A273 contains the upper 4 digits and A272 contains the lower 4 digits. <ul style="list-style-type: none"> <li>Cleared when operation starts.</li> </ul>			Cleared	<ul style="list-style-type: none"> <li>Refreshed each cycle during the overseeing processes.</li> <li>Refreshed when PRV instruction is executed to read the PV.</li> </ul>	
A274	00	High-speed Counter 0 Range 1 Comparison Condition Met Flag	These flags indicate whether the PV is within the specified ranges when high-speed counter 0 is being operated in range-comparison mode. <ul style="list-style-type: none"> <li>Cleared when operation starts.</li> <li>Cleared when range comparison table is registered.</li> </ul> OFF: PV not in range ON: PV in range			Cleared	<ul style="list-style-type: none"> <li>Refreshed each cycle during the overseeing processes.</li> <li>Refreshed when PRV instruction is executed to read the results of range comparison.</li> </ul>	
	01	High-speed Counter 0 Range 2 Comparison Condition Met Flag						
	02	High-speed Counter 0 Range 3 Comparison Condition Met Flag						
	03	High-speed Counter 0 Range 4 Comparison Condition Met Flag						
	04	High-speed Counter 0 Range 5 Comparison Condition Met Flag						
	05	High-speed Counter 0 Range 6 Comparison Condition Met Flag						
	08	High-speed Counter 0 Comparison In-progress Flag	This flag indicates whether a comparison operation is being executed for high-speed counter 0. Cleared when operation starts. OFF: Stopped. ON: Being executed.					
	09	High-speed Counter 0 Overflow/Underflow Flag	This flag indicates when an overflow or underflow has occurred in the high-speed counter 0 PV. (Used with the linear mode counting range only.) <ul style="list-style-type: none"> <li>Cleared when operation starts.</li> <li>Cleared when PV is changed.</li> </ul> OFF: Normal ON: Overflow or underflow					
10	High-speed Counter 0 Count Direction	This flag indicates whether the high-speed counter 0 is currently being incremented or decremented. The counter PV for the current cycle is compared with the PV in last cycle to determine the direction. OFF: Decrementing ON: Incrementing						

Address		Name	Function	Settings	Status after mode change	Status at startup	Write timing	Related flags, settings
Words	Bits							
A275	00	High-speed Counter 1 Range 1 Comparison Condition Met Flag	These flags indicate whether the PV is within the specified ranges when high-speed counter 1 is being operated in range-comparison mode for upper and lower limits. <ul style="list-style-type: none"> <li>Cleared when operation starts.</li> <li>Cleared when range comparison table is registered.</li> </ul> OFF: PV not in range ON: PV in range			Cleared	<ul style="list-style-type: none"> <li>Refreshed each cycle during over-seeing process.</li> <li>Refreshed when PRV instruction is executed to read the comparison results for the corresponding counter.</li> </ul>	
	01	High-speed Counter 1 Range 2 Comparison Condition Met Flag						
	02	High-speed Counter 1 Range 3 Comparison Condition Met Flag						
	03	High-speed Counter 1 Range 4 Comparison Condition Met Flag						
	04	High-speed Counter 1 Range 5 Comparison Condition Met Flag						
	05	High-speed Counter 1 Range 6 Comparison Condition Met Flag						
	08	High-speed Counter 1 Comparison In-progress Flag	This flag indicates whether a comparison operation is being executed for high-speed counter 1. <ul style="list-style-type: none"> <li>Cleared when operation starts.</li> </ul> OFF: Stopped. ON: Being executed			Cleared	Refreshed when comparison operation starts or stops.	
	09	High-speed Counter 1 Overflow/Underflow Flag	This flag indicates when an overflow or underflow has occurred in the high-speed counter 1 PV. (Used with the linear mode counting range only.) <ul style="list-style-type: none"> <li>Cleared when operation starts.</li> <li>Cleared when the PV is changed.</li> </ul> OFF: Normal ON: Overflow or underflow			Cleared	Refreshed when an overflow or underflow occurs.	
	10	High-speed Counter 1 Count Direction	This flag indicates whether the high-speed counter 1 is currently being incremented or decremented. The counter PV for the current cycle is compared with the PV in last cycle to determine the direction. OFF: Decrementing ON: Incrementing			Cleared	Setting used for high-speed counter, valid during counter operation.	
	A276	Pulse Output 0 PV	Lower four digits	Contain the number of pulses output from the corresponding pulse output port. PV range: 8000 0000 to 7FFF FFFF hex (-2,147,483,648 to 2,147,483,647) When pulses are being output in the CW direction, the PV is incremented by 1 for each pulse. When pulses are being output in the CCW direction, the PV is decremented by 1 for each pulse. PV after overflow: 7FFF FFFF hex PV after underflow: 8000 000 hex <ul style="list-style-type: none"> <li>Cleared when operation starts.</li> </ul> <b>Note</b> If the coordinate system is relative coordinates (undefined origin), the PV will be cleared to 0 when a pulse output starts, i.e. when a pulse output instruction (SPED, ACC, or PLS2) is executed.			Cleared	<ul style="list-style-type: none"> <li>Refreshed each cycle during the overseeing processes.</li> <li>Refreshed when the INI instruction is executed (PV change).</li> </ul>
A277	Upper four digits							
A278	Pulse Output 1 PV	Lower four digits						
A279		Upper four digits						

Address		Name	Function	Settings	Status after mode change	Status at startup	Write timing	Related flags, settings
Words	Bits							
A280	00	Pulse Output 0 Accel/Decel Flag	<p>This flag will be ON when pulses are being output from pulse output 0 according to an ORG, ACC or PLS2 instruction and the output frequency is being changed in steps (accelerating or decelerating).</p> <ul style="list-style-type: none"> <li>Cleared when operation starts or stops.</li> </ul> <p>OFF: Constant speed ON: Accelerating or decelerating</p>			Cleared	Refreshed each cycle during the overseeing processes.	
	01	Pulse Output 0 Overflow/Underflow Flag	<p>This flag indicates when an overflow or underflow has occurred in the pulse output 0 PV.</p> <ul style="list-style-type: none"> <li>Cleared when operation starts.</li> </ul> <p>OFF: Normal ON: Overflow or underflow</p>			Cleared	<ul style="list-style-type: none"> <li>Refreshed when the PV is changed by the INI instruction.</li> <li>Refreshed when an overflow or underflow occurs.</li> </ul>	
	02	Pulse Output 0 Output Amount Set Flag	<p>ON when the number of output pulses for pulse output 0 has been set with the PULS instruction.</p> <ul style="list-style-type: none"> <li>Cleared when operation starts or stops.</li> </ul> <p>OFF: No setting ON: Setting made</p>			Cleared	<ul style="list-style-type: none"> <li>Refreshed when the PULS instruction is executed.</li> <li>Refreshed when pulse output stops.</li> </ul>	
	03	Pulse Output 0 Output Completed Flag	<p>ON when the number of output pulses set with the PULS or PLS2 instruction has been output through pulse output 0.</p> <ul style="list-style-type: none"> <li>Cleared when operation starts or stops.</li> </ul> <p>OFF: Output not completed. ON: Output completed.</p>			Cleared	Refreshed at the start or completion of pulse output.	
	04	Pulse Output 0 Output In-progress Flag	<p>ON when pulses are being output from pulse output 0.</p> <ul style="list-style-type: none"> <li>Cleared when operation starts or stops.</li> </ul> <p>OFF: Stopped ON: Outputting pulses.</p>			Cleared	Refreshed when pulse output starts or stops.	
	05	Pulse Output 0 No-origin Flag	<p>ON when the origin has not been determined for pulse output 0 and goes OFF when the origin has been determined.</p> <ul style="list-style-type: none"> <li>Turned ON when power is turned ON.</li> <li>Turned ON when operation starts.</li> </ul> <p>OFF: Origin established. ON: Origin not established.</p>			Cleared	Refreshed each cycle during the overseeing processes.	
	06	Pulse Output 0 At-origin Flag	<p>ON when the pulse output 0 PV matches the origin (0).</p> <p>OFF: Not stopped at origin. ON: Stopped at origin.</p>			Cleared	Refreshed each cycle during the overseeing processes.	
	07	Pulse Output 0 Output Stopped Error Flag	<p>ON when an error occurred while outputting pulses in the pulse output 0 origin search function.</p> <p>The Pulse Output 0 Output Stop Error code will be written to A444.</p> <p>OFF: No error ON: Stop error occurred.</p>			Cleared	<ul style="list-style-type: none"> <li>Refreshed when origin search starts.</li> <li>Refreshed when a pulse output stop error occurs.</li> </ul>	

Address		Name	Function	Settings	Status after mode change	Status at startup	Write timing	Related flags, settings
Words	Bits							
A281	00	Pulse Output 1 Accel/Decel Flag	<p>This flag will be ON when pulses are being output from pulse output 1 according to an ORG, ACC or PLS2 instruction and the output frequency is being changed in steps (accelerating or decelerating).</p> <ul style="list-style-type: none"> <li>Cleared when operation starts or stops.</li> </ul> <p>OFF: Constant speed ON: Accelerating or decelerating</p>			Cleared	Refreshed each cycle during the overseeing processes.	
	01	Pulse Output 1 Overflow/Underflow Flag	<p>This flag indicates when an overflow or underflow has occurred in the pulse output 1 PV.</p> <ul style="list-style-type: none"> <li>Cleared when operation starts.</li> </ul> <p>OFF: Normal ON: Overflow or underflow</p>			Cleared	<ul style="list-style-type: none"> <li>Refreshed when the PV is changed by the INI instruction.</li> <li>Refreshed when an overflow or underflow occurs.</li> </ul>	
	02	Pulse Output 1 Output Amount Set Flag	<p>ON when the number of output pulses for pulse output 1 has been set with the PULS instruction.</p> <ul style="list-style-type: none"> <li>Cleared when operation starts or stops.</li> </ul> <p>OFF: No setting ON: Setting made</p>			Cleared	<ul style="list-style-type: none"> <li>Refreshed when the PULS instruction is executed.</li> <li>Refreshed when pulse output stops.</li> </ul>	
	03	Pulse Output 1 Output Completed Flag	<p>ON when the number of output pulses set with the PULS or PLS2 instruction has been output through pulse output 1.</p> <ul style="list-style-type: none"> <li>Cleared when operation starts or stops.</li> </ul> <p>OFF: Output not completed. ON: Output completed.</p>			Cleared	Refreshed at the start or completion of pulse output.	
	04	Pulse Output 1 Output In-progress Flag	<p>ON when pulses are being output from pulse output 1.</p> <ul style="list-style-type: none"> <li>Cleared when operation starts or stops.</li> </ul> <p>OFF: Stopped ON: Outputting pulses.</p>			Cleared	Refreshed when pulse output starts or stops.	
	05	Pulse Output 1 No-origin Flag	<p>ON when the origin has not been determined for pulse output 1 and goes OFF when the origin has been determined.</p> <ul style="list-style-type: none"> <li>Turned ON when power is turned ON.</li> <li>Turned ON when operation starts.</li> </ul> <p>OFF: Origin established. ON: Origin not established.</p>			Cleared	Refreshed each cycle during overseeing processes.	
	06	Pulse Output 1 At-origin Flag	<p>ON when the pulse output 1 PV matches the origin (0).</p> <p>OFF: Not stopped at origin. ON: Stopped at origin.</p>			Cleared	Refreshed each cycle during overseeing processes.	
	07	Pulse Output 1 Output Stopped Error Flag	<p>ON when an error occurred while outputting pulses in the pulse output 1 origin search function.</p> <p>The Pulse Output 1 Output Stop Error code will be written to A445.</p> <p>OFF: No error ON: Stop error occurred.</p>			Cleared	<ul style="list-style-type: none"> <li>Refreshed when origin search starts.</li> <li>Refreshed when pulse output stop error occurs.</li> </ul>	

Address		Name	Function	Settings	Status after mode change	Status at startup	Write timing	Related flags, settings
Words	Bits							
A283	00	PWM Output 0 Output In-progress Flag	ON when pulses are being output from PWM output 0. <ul style="list-style-type: none"> <li>Cleared when operation starts or stops.</li> </ul> OFF: Stopped ON: Outputting pulses.			Cleared	Refreshed when pulse output starts or stops.	
A294		Task Number when Program Stopped	This word contains the task number of the task that was being executed when program execution was stopped because of a program error.  <b>Note</b> A298 and A299 contain the program address where program execution was stopped.	Cyclic tasks: 0000 Interrupt tasks: 8000 to 800F (task 0 to 15)	Cleared	Cleared	When program error occurs.	A298/ A299
A295	08	Instruction Processing Error Flag	This flag and the Error Flag (ER) will be turned ON when an instruction processing error has occurred and the PLC Setup has been set to stop operation for an instruction error. CPU Unit operation will stop and the ERR/ALM indicator will light when this flag goes ON.  <b>Note</b> The task number where the error occurred will be stored in A294 and the program address will be stored in A298 and A299.	ON: Error Flag ON OFF: Error Flag OFF	Cleared	Cleared	When program error occurs.	A294, A298/ A299  PLC Setup (Operation when instruction error has occurred)
	09	Indirect DM BCD Error Flag	This flag and the Access Error Flag (AER) will be turned ON when an indirect DM BCD error has occurred and the PLC Setup has been set to stop operation an indirect DM BCD error. (This error occurs when the content of an indirectly addressed DM word is not BCD although BCD mode has been selected.) CPU Unit operation will stop and the ERR/ALM indicator will light when this flag goes ON.  <b>Note</b> The task number where the error occurred will be stored in A294 and the program address will be stored in A298 and A299.	ON: Not BCD OFF: Normal	Cleared	Cleared	When program error occurs.	A294, A298/ A299  PLC Setup (Operation when instruction error has occurred)



Address		Name	Function	Settings	Status after mode change	Status at startup	Write timing	Related flags, settings
Words	Bits							
A295	10	Illegal Access Error Flag	This flag and the Access Error Flag (AER) will be turned ON when an illegal access error has occurred and the PLC Setup has been set to stop operation an illegal access error. (This error occurs when a region of memory is accessed illegally.) CPU Unit operation will stop and the ERR/ALM indicator will light when this flag goes ON.  The following operations are considered illegal access: <ul style="list-style-type: none"> <li>• Reading/writing the system area</li> <li>• Indirect DM BCD error (in BCD mode)</li> </ul> <b>Note</b> The task number where the error occurred will be stored in A294 and the program address will be stored in A298 and A299.	ON: Illegal access occurred OFF: Normal condition	Cleared	Cleared	When program error occurs.	A294, A298/A299 PLC Setup (Operation when instruction error has occurred)
	11	No END Error Flag	ON when there isn't an END instruction in each program within a task. CPU Unit operation will stop and the ERR/ALM indicator will light when this flag goes ON.  <b>Note</b> The task number where the error occurred will be stored in A294 and the program address will be stored in A298 and A299.	ON: No END OFF: Normal condition	Cleared	Cleared		A294, A298/A299
	12	Task Error Flag	ON when a task error has occurred. A task error will occur when there is no program allocated to the task.  <b>Note</b> The task number where the error occurred will be stored in A294 and the program address will be stored in A298 and A299.	ON: Error OFF: Normal	Cleared	Cleared		A294, A298/A299
	13	Differentiation Overflow Error Flag	The allowed value for Differentiation Flags which correspond to differentiation instructions has been exceeded. CPU Unit operation will stop and the ERR/ALM indicator will light when this flag goes ON.  <b>Note</b> The task number where the error occurred will be stored in A294 and the program address will be stored in A298 and A299.	ON: Error OFF: Normal	Cleared	Cleared		A294, A298/A299
	14	Illegal Instruction Error Flag	ON when a program that cannot be executed has been stored. CPU Unit operation will stop and the ERR/ALM indicator will light when this flag goes ON.	ON: Error OFF: Normal	Cleared	Cleared		A294, A298/A299
	15	UM Overflow Error Flag	ON when the last address in UM (User Memory) has been exceeded. CPU Unit operation will stop and the ERR/ALM indicator will light when this flag goes ON.	ON: Error OFF: Normal	Cleared	Cleared		A294, A298/A299
A298		Program Address Where Program Stopped (Lower digits)	These words contain the program address of the instruction where program execution was stopped due to a program error.	Lower digits of the program address	Cleared	Cleared		A294
A299		Program Address Where Program Stopped (Upper digits)	<b>Note</b> A294 contains the task number of the task where program execution was stopped.	Upper digits of the program address	Cleared	Cleared		

Address		Name	Function	Settings	Status after mode change	Status at startup	Write timing	Related flags, settings
Words	Bits							
A300		Error Log Pointer	<p>When an error occurs, the Error Log Pointer is incremented by 1 to indicate the location where the next error record will be recorded as an offset from the beginning of the Error Log Area (A100 to A199).</p> <p><b>Note 1</b> The data will be unstable if the capacitor becomes discharged.</p> <p><b>2</b> The Error Log Pointer can be cleared to 00 by turning A500.14 (the Error Log Reset Bit) ON.</p> <p><b>3</b> When the Error Log Pointer has reached 14 hex (20 decimal), the next record is stored in A195 to A199 when the next error occurs.</p>	00 to 14 hex	Retained	Retained	Refreshed when error occurs.	A500.14
A310		Manufacturing Lot Number, Lower Digits	<p>The manufacturing lot number is stored in 6 digits hexadecimal. X, Y, and Z in the lot number are converted to 10, 11, and 12, respectively.</p> <p>Examples:                      Lot number 01805                      A310 = 0801, A311 = 0005</p> <p>Lot number 30Y05                      A310 = 1130, A311 = 0005</p>		Retained	Retained		
A311		Manufacturing Lot Number, Upper Digits						
A315	13	Option Board Error Flag	<p>ON when the Option Board is removed while the power is being supplied. CPU Unit operation will continue and the ERR/ALM indicator will flash.</p> <p><b>Note</b> OFF when the error has been cleared.</p>		Cleared	Cleared	Refreshed when a non-fatal error occurs.	A402.00, A424
	14	Built-in Analog I/O Error Flag	<p>ON when a built-in analog I/O error occurs and stops the operation of built-in analog I/O. CPU Unit operation will continue and the ERR/ALM indicator will flash. OFF when the error has been cleared.</p>		Cleared	Cleared	Refreshed when a non-fatal error occurs.	A402.00
	15	Backup Memory Error Flag	<p>ON when writing to the built-in EEPROM backup memory fails. CPU Unit operation will continue and the ERR/ALM indicator will flash.</p> <p><b>Note</b> OFF when the error has been cleared.</p>		Cleared	Cleared	Refreshed when a non-fatal error occurs.	A402.00
A316 to A317		High-speed Counter 2 PV	<p>Contains the PV of high-speed counter 2.</p> <ul style="list-style-type: none"> <li>The PV is cleared when operation starts.</li> </ul> <p>A317 contains the upper 4 digits and A316 contains the lower 4 digits.</p>			Cleared	<ul style="list-style-type: none"> <li>Refreshed each cycle during the overseeing processes.</li> <li>Refreshed when PRV instruction is executed to read PV.</li> </ul>	
A318 to A319		High-speed Counter 3 PV	<p>Contains the PV of high-speed counter 3.</p> <ul style="list-style-type: none"> <li>The PV is cleared when operation starts.</li> </ul> <p>A319 contains the upper 4 digits and A318 contains the lower 4 digits.</p>			Cleared	<ul style="list-style-type: none"> <li>Refreshed each cycle during the overseeing processes.</li> <li>Refreshed when PRV instruction is executed to read PV.</li> </ul>	

Address		Name	Function	Settings	Status after mode change	Status at startup	Write timing	Related flags, settings
Words	Bits							
A320	00	High-speed Counter 2 Range 1 Comparison Condition Met Flag	<p>These flags indicate whether the PV is within the specified ranges when high-speed counter 2 is being operated in range-comparison mode for upper and lower limits.</p> <ul style="list-style-type: none"> <li>• Cleared when operation starts.</li> <li>• Cleared when range comparison table is registered.</li> </ul> <p>OFF: PV not in range ON: PV in range</p>			Cleared	<ul style="list-style-type: none"> <li>• Refreshed each cycle during the overseeing processes.</li> <li>• Refreshed when PRV instruction is executed to read the results of range comparison.</li> </ul>	
	01	High-speed Counter 2 Range 2 Comparison Condition Met Flag						
	02	High-speed Counter 2 Range 3 Comparison Condition Met Flag						
	03	High-speed Counter 2 Range 4 Comparison Condition Met Flag						
	04	High-speed Counter 2 Range 5 Comparison Condition Met Flag						
	05	High-speed Counter 2 Range 6 Comparison Condition Met Flag						
	08	High-speed Counter 2 Comparison In-progress Flag	<p>This flag indicates whether a comparison operation is being executed for high-speed counter 2.</p> <ul style="list-style-type: none"> <li>• Cleared when operation starts.</li> </ul> <p>OFF: Stopped. ON: Being executed.</p>			Cleared	Refreshed when comparison operation starts or stops.	
	09	High-speed Counter 2 Overflow/Underflow Flag	<p>This flag indicates when an overflow or underflow has occurred in the high-speed counter 2 PV. (Used with the linear mode counting range only.)</p> <ul style="list-style-type: none"> <li>• Cleared when operation starts.</li> <li>• Cleared when PV is changed.</li> </ul> <p>OFF: Normal ON: Overflow or underflow</p>			Cleared	Refreshed when an overflow or underflow occurs.	
	10	High-speed Counter 2 Count Direction	<p>This flag indicates whether the high-speed counter 2 is currently being incremented or decremented. The counter PV for the current cycle is compared with the PV in last cycle to determine the direction.</p> <p>OFF: Decrementing ON: Incrementing</p>			Cleared	Setting used for high-speed counter, valid during counter operation.	
	A321	00	High-speed Counter 3 Range 1 Comparison Condition Met Flag	<p>These flags indicate whether the PV is within the specified ranges when high-speed counter 3 is being operated in range-comparison mode for upper and lower limits.</p> <ul style="list-style-type: none"> <li>• Cleared when operation starts.</li> <li>• Cleared when range comparison table is registered.</li> </ul> <p>OFF: PV not in range ON: PV in range</p>			Cleared	<ul style="list-style-type: none"> <li>• Refreshed each cycle during overseeing process.</li> <li>• Refreshed when PRV instruction is executed to read the results of range comparison.</li> </ul>
01		High-speed Counter 3 Range 2 Comparison Condition Met Flag						
02		High-speed Counter 3 Range 3 Comparison Condition Met Flag						
03		High-speed Counter 3 Range 4 Comparison Condition Met Flag						
04		High-speed Counter 3 Range 5 Comparison Condition Met Flag						
05		High-speed Counter 3 Range 6 Comparison Condition Met Flag						

Address		Name	Function	Settings	Status after mode change	Status at startup	Write timing	Related flags, settings
Words	Bits							
A321	08	High-speed Counter 3 Comparison In-progress Flag	This flag indicates whether a comparison operation is being executed for high-speed counter 3. <ul style="list-style-type: none"> <li>Cleared when operation starts.</li> </ul> OFF: Stopped. ON: Being executed			Cleared	Refreshed when comparison operation starts or stops.	
	09	High-speed Counter 3 Overflow/Underflow Flag	This flag indicates when an overflow or underflow has occurred in the high-speed counter 3 PV. (Used with the linear mode counting range only.) <ul style="list-style-type: none"> <li>Cleared when operation starts.</li> <li>Cleared when the PV is changed.</li> </ul> OFF: Normal ON: Overflow or underflow			Cleared	Refreshed when an overflow or underflow occurs.	
	10	High-speed Counter 3 Count Direction	This flag indicates whether the high-speed counter is currently being incremented or decremented. The counter PV for the current cycle is compared with the PV in last cycle to determine the direction. OFF: Decrementing ON: Incrementing			Cleared	Setting used for high-speed counter, valid during counter operation.	
A322 to A323		High-speed Counter 4 PV	Contains the PV of high-speed counter 4. <ul style="list-style-type: none"> <li>The PV will be cleared at the start of operation.</li> </ul> A323 contains the upper four digits and A322 contains the lower four digits.			Cleared	<ul style="list-style-type: none"> <li>Refreshed each cycle during the overseeing processes.</li> <li>Refreshed when PRV instruction is executed to read PV.</li> </ul>	
A324 to A325 (Not supported by E10 CPU Unit)		High-speed Counter 5 PV	Contains the PV of high-speed counter 5. <ul style="list-style-type: none"> <li>The PV is cleared when operation starts.</li> </ul> A325 contains the upper 4 digits and A324 contains the lower 4 digits.			Cleared	<ul style="list-style-type: none"> <li>Refreshed each cycle during the overseeing processes.</li> <li>Refreshed when PRV instruction is executed to read PV.</li> </ul>	
A326	00	High-speed Counter 4 Range 1 Comparison Condition Met Flag	These flags indicate whether the PV is within the specified ranges when high-speed counter 4 is being operated in range-comparison mode for upper and lower limits. <ul style="list-style-type: none"> <li>Cleared when operation starts.</li> <li>Cleared when range comparison table is registered.</li> </ul> OFF: PV not in range ON: PV in range			Cleared	<ul style="list-style-type: none"> <li>Refreshed each cycle during the overseeing processes.</li> <li>Refreshed when PRV instruction is executed to read the results of range comparison.</li> </ul>	
	01	High-speed Counter 4 Range 2 Comparison Condition Met Flag						
	02	High-speed Counter 4 Range 3 Comparison Condition Met Flag						
	03	High-speed Counter 4 Range 4 Comparison Condition Met Flag						
	04	High-speed Counter 4 Range 5 Comparison Condition Met Flag						
	05	High-speed Counter 4 Range 6 Comparison Condition Met Flag						

Address		Name	Function	Settings	Status after mode change	Status at startup	Write timing	Related flags, settings
Words	Bits							
A326	08	High-speed Counter 4 Comparison In-progress Flag	This flag indicates whether a comparison operation is being executed for high-speed counter 4. <ul style="list-style-type: none"> <li>Cleared when operation starts.</li> </ul> OFF: Stopped. ON: Being executed.			Cleared	Refreshed when comparison operation starts or stops.	
	09	High-speed Counter 4 Overflow/Underflow Flag	This flag indicates when an overflow or underflow has occurred in the high-speed counter 4 PV. (Used with the linear mode counting range only.) <ul style="list-style-type: none"> <li>Cleared when operation starts.</li> <li>Cleared when PV is changed.</li> </ul> OFF: Normal ON: Overflow or underflow			Cleared	Refreshed when an overflow or underflow occurs.	
	10	High-speed Counter 4 Count Direction	This flag indicates whether the high-speed counter is currently being incremented or decremented. The counter PV for the current cycle is compared with the PV in last cycle to determine the direction. OFF: Decrementing ON: Incrementing			Cleared	Setting used for high-speed counter, valid during counter operation.	
A327 (Not supported by E10 CPU Unit)	00	High-speed Counter 5 Range 1 Comparison Condition Met Flag	These flags indicate whether the PV is within the specified ranges when high-speed counter 5 is being operated in range-comparison mode. <ul style="list-style-type: none"> <li>Cleared when operation starts.</li> <li>Cleared when range comparison table is registered.</li> </ul> OFF: PV not in range ON: PV in range			Cleared	<ul style="list-style-type: none"> <li>Refreshed each cycle during overseeing process.</li> <li>Refreshed when PRV instruction is executed to read the results of range comparison.</li> </ul>	
	01	High-speed Counter 5 Range 2 Comparison Condition Met Flag						
	02	High-speed Counter 5 Range 3 Comparison Condition Met Flag						
	03	High-speed Counter 5 Range 4 Comparison Condition Met Flag						
	04	High-speed Counter 5 Range 5 Comparison Condition Met Flag						
	05	High-speed Counter 5 Range 6 Comparison Condition Met Flag						
	08	High-speed Counter 5 Comparison In-progress Flag	This flag indicates whether a comparison operation is being executed for high-speed counter 5. <ul style="list-style-type: none"> <li>Cleared when operation starts.</li> </ul> OFF: Stopped. ON: Being executed			Cleared	Refreshed when comparison operation starts or stops.	
09	High-speed Counter 5 Overflow/Underflow Flag	This flag indicates when an overflow or underflow has occurred in the high-speed counter 5 PV. (Used with the linear mode counting range only.) <ul style="list-style-type: none"> <li>Cleared when operation starts.</li> <li>Cleared when the PV is changed.</li> </ul> OFF: Normal ON: Overflow or underflow			Cleared	Refreshed when an overflow or underflow occurs.		

Address		Name	Function	Settings	Status after mode change	Status at startup	Write timing	Related flags, settings
Words	Bits							
A327	10	High-speed Counter 5 Count Direction	This flag indicates whether the high-speed counter is currently being incremented or decremented. The counter PV for the current cycle is compared with the PV in last cycle to determine the direction.  OFF: Decrementing ON: Incrementing			Cleared	Setting used for high-speed counter, valid during counter operation.	
A339 to A340		Maximum Differentiation Flag Number	These words contain the maximum value of the differentiation flag numbers being used by differentiation instructions.		See Function column.	Cleared	Written at the start of operation	A295.13
A351 to A354 (N/NA-type CPU Unit only)		Calendar/Clock Area	These words contain the CPU Unit's internal clock data in BCD. The clock can be set from the CX-Programmer, with the DATE instruction, or with a FINS command (CLOCK WRITE, 0702).  A351.00 to A351.07: Seconds (00 to 59)(BCD) A351.08 to A351.15: Minutes (00 to 59)(BCD) A352.00 to A352.07: Hours (00 to 23)(BCD) A352.08 to A352.15: Day of the month (01 to 31)(BCD) A353.00 to A353.07: Month (01 to 12)(BCD) A353.08 to A353.15: Year (00 to 99)(BCD) A354.00 to A354.07: Day of the week (00 to 06)(BCD) 00: Sunday 01: Monday 02: Tuesday 03: Wednesday 04: Thursday 05: Friday 06: Saturday  <b>Note 1</b> The data will be unstable if the capacitor becomes discharged. Write the ladder program and design the overall system to handle any problems that might occur if this data becomes unstable.  <b>2</b> In an E□□(S)-type CPU Unit, or if the clock data is not set for an N/NA□□(S)-type CPU Unit, the data will be for 1:01.01 on Sunday January 1, 2001.		Retained	Retained	Written every cycle	
A360 to A391	01 to 15	Executed FAL Number Flags	The flag corresponding to the specified FAL number will be turned ON when FAL is executed. Bits A360.01 to A391.15 correspond to FAL numbers 001 to 511.  <b>Note</b> The flag will be turned OFF when the error is cleared.	ON: That FAL was executed OFF: That FAL wasn't executed	Retained	Cleared	Refreshed when error occurs.	A402.15

Address		Name	Function	Settings	Status after mode change	Status at startup	Write timing	Related flags, settings
Words	Bits							
A392	04	Built-in RS-232C Port Error Flag (CP1E N/NA□□(S)-type CPU Unit only)	ON when an error has occurred at the built-in RS-232C port. (Not valid in NT Link mode.)	ON: Error OFF: No error	Retained	Cleared	Refreshed when error occurs.	
	05	Built-in RS-232C Port Send Ready Flag (No-protocol mode) (CP1E N/NA□□(S)-type CPU Unit only)	ON when the built-in RS-232C port is able to send data in no-protocol mode.	ON: Able-to-send OFF: Unable-to-send	Retained	Cleared	Written after transmission	
	06	Built-in RS-232C Port Reception Completed Flag (No-protocol mode) (CP1E N/NA□□(S)-type CPU Unit only)	ON when the built-in RS-232C port has completed the reception in no-protocol mode. <ul style="list-style-type: none"> <li>When the number of bytes was specified: ON when the specified number of bytes is received.</li> <li>When the end code was specified: ON when the end code is received or 256 bytes are received.</li> </ul>	ON: Reception completed OFF: Reception not completed	Retained	Cleared	Written after reception	
	07	Built-in RS-232C Port Reception Overflow Flag (No-protocol mode) (CP1E N/NA□□(S)-type CPU Unit only)	ON when a data overflow occurred during reception through the built-in RS-232C port in no-protocol mode. <ul style="list-style-type: none"> <li>When the number of bytes was specified: ON when more data is received after the reception was completed but before RXD was executed.</li> <li>When the end code was specified: ON when more data is received after the end code was received but before RXD was executed. ON when 257 bytes are received before the end code.</li> </ul>	ON: Overflow OFF: No overflow	Retained	Cleared		
	12	Serial Option Port/ Built-in RS-485 Port Communications Error Flag (CP1E N30/40/60 (S□) or NA20 CPU Unit only)	ON when a communications error has occurred at the serial option port or built-in RS-485 port. (Not valid in NT Link mode.)	ON: Error OFF: No error	Retained	Cleared		
	13	Serial Option Port/ Built-in RS-485 Port Send Ready Flag (No-protocol Mode) (CP1E N30/40/60(S□) or NA20 CPU Unit only)	ON when the serial option port or built-in RS-485 port is able to send data in no-protocol mode.	ON: Able-to-send OFF: Unable-to-send	Retained	Cleared	Written after transmission	
	14	Serial Option Port/ Built-in RS-485 Port Reception Completed Flag (No-protocol mode) (CP1E N30/40/60(S□) or NA20 CPU Unit only)	ON when the serial option port or built-in RS-485 port has completed the reception in no-protocol mode. <ul style="list-style-type: none"> <li>When the number of bytes was specified: ON when the specified number of bytes is received.</li> <li>When the end code was specified: ON when the end code is received or 256 bytes are received.</li> </ul>	ON: Reception completed OFF: Reception not completed	Retained	Cleared	Written after reception	
15	Serial Option Port/ Built-in RS-485 Port Reception Overflow Flag (No-protocol mode) (CP1E N30/40/60(S□) or NA20 CPU Unit only)	ON when a data overflow occurred during reception through serial option port or built-in RS-485 port in no-protocol mode. <ul style="list-style-type: none"> <li>When the number of bytes was specified: ON when more data is received after the reception was completed but before RXD was executed.</li> <li>When the end code was specified: ON when more data is received after the end code was received but before RXD was executed. ON when 257 bytes are received before the end code.</li> </ul>	ON: Reception completed OFF: Reception not completed	Retained	Cleared			

Address		Name	Function	Settings	Status after mode change	Status at startup	Write timing	Related flags, settings
Words	Bits							
A393	00 to 07	Built-in RS-232C Port Polled Unit Communications Flags (CP1E N/NA□□(S)-type CPU Unit only)	The corresponding bit will be ON when the built-in RS-232C port is communicating with NT Link mode or Serial PLC Link mode. Bits 0 to 7 correspond to Units 0 to 7.	ON: Communicating OFF: Not communicating	Retained	Cleared	Refreshed when there is a normal response to the token.	
	00 to 15	Built-in RS-232C Port Reception Counter (No-protocol Mode) (CP1E N/NA□□(S)-type CPU Unit only)	Indicates (in binary) the number of bytes of data received when the built-in RS-232C port is in no-protocol mode.		Retained	Cleared	Refreshed when data is received.	
A394	00 to 07	Serial Option Port/ Built-in RS-485 Port Polled Unit Communications Flags (CP1E N30/40/60(S□) or NA20 CPU Unit only)	The corresponding bit will be ON when the serial option port or built-in RS-485 port is communicating with NT link mode. Bits 0 to 7 correspond to Units 0 to 7.	ON: Communicating OFF: Not communicating	Retained	Cleared	Refreshed when there is a normal response to the token.	
	00 to 15	Serial Option Port/ Built-in RS-485 Port Reception Counter (No-protocol Mode) (CP1E N30/40/60(S□) or NA20 CPU Unit only)	Indicates (in binary) the number of bytes of data received when the serial option port or built-in RS-485 port is in no-protocol mode.		Retained	Cleared	Refreshed when data is received.	
A400		Error code	When a non-fatal error (user-defined FALS or system error) or a fatal error (user-defined FALS or system error) occurs, the 4-digit hexadecimal error code is written to this word.  <b>Note</b> When two or more errors occur simultaneously, the highest error code will be recorded.		Cleared	Cleared	Refreshed when error occurs.	
A401	00	Other Fatal Error Flag	ON when a fatal error that is not defined for A401.01 to A401.15 occurs. Detailed information is output to the bits of A314.  <b>Note</b> There are no errors that affect this flag at this time. This flag is reserved by the system.	OFF: No other fatal error ON: Other fatal error	Cleared	Cleared	Refreshed when error occurs.	A314
	06	FALS Error Flag (fatal error)	ON when a fatal error is generated by the FALS instruction. The CPU Unit will stop operating and the ERR/ALM indicator will light.  The corresponding error code will be written to A400. Error codes C101 to C2FF correspond to FALS numbers 001 to 511.  <b>Note</b> This flag will be turned OFF when the FALS errors are cleared.	ON: FALS executed OFF: FALS not executed	Cleared	Cleared	Refreshed when error occurs.	A400
	08	Cycle Time Too Long Flag (fatal error)	ON if the cycle time exceeds the maximum cycle time set in the PLC Setup (the cycle time monitoring time). CPU Unit operation will stop and the ERR/ALM indicator on the front of the CPU Unit will light.  <b>Note</b> This flag will be turned OFF when the error is cleared.	OFF: Cycle time under max. ON: Cycle time over max.	Cleared	Cleared	Refreshed when the cycle time exceeds maximum.	PLC Setup (Cycle time monitoring time)



Address		Name	Function	Settings	Status after mode change	Status at startup	Write timing	Related flags, settings
Words	Bits							
A401	09	Program Error Flag (fatal error)	ON when program contents are incorrect. CPU Unit operation will stop and the ERR/ALM indicator on the front of the CPU Unit will light. The task number where the error occurred will be stored in A294 and the program address will be stored in A298 and A299. The type of program error that occurred will be stored in A295.08 to A295.15. Refer to the description of A295 for more details on program errors.	ON: Error OFF: No error	Cleared	Cleared	Refreshed when error occurs.	A294, A295, A298 and A299
	11	Too Many I/O Points Flag (fatal error)	ON when the number of Expansion Units and Expansion I/O Units exceeds the limit, when the number of words allocated to these Units exceeds the limit, are mounted.  CPU Unit operation will stop and the ERR/ALM indicator on the front of the CPU Unit will light.	ON: Error OFF: No error	Cleared	Cleared	Refreshed when error occurs.	A407
	14	I/O Bus Error Flag (fatal error)	ON in the following cases: <ul style="list-style-type: none"> <li>When an error occurs in a data transfer between the CPU Unit and a Expansion Unit or Expansion I/O Unit. If this happens, 0A0A hex will be output to A404.</li> </ul> CPU Unit operation will stop and the ERR/ALM indicator on the front of the CPU Unit will light. This flag will be turned OFF when the error is cleared.	ON: Error OFF: No error	Cleared	Cleared	Refreshed when error occurs.	A404
	15	Memory Error Flag (fatal error)	ON when an error occurred in memory. CPU Unit operation will stop and the ERR/ALM indicator on the front of the CPU Unit will light. The location where the error occurred is indicated in A403.00 to A403.08, and A403.09 will be turned ON if there was an error during automatic transfer at startup. This flag will be turned OFF when the error is cleared. The automatic transfer at startup error cannot be cleared without turning OFF the PLC.	ON: Error OFF: No error	Cleared	Cleared	Refreshed when error occurs.	A403.00 to A403.08, A403.09
A402	00	Other Non-Fatal Error Flag	ON when a non-fatal error that is not defined for A402.01 to A402.15 occurs. Detailed information is output to the bits of A315.	OFF: No other non-fatal error ON: Other non-fatal error	Cleared	Cleared	Refreshed when error occurs.	A315
	04	Battery Error Flag (non-fatal error)	ON if the CPU Unit's battery is disconnected or its voltage is low and the Detect Battery Error setting has been set in the PLC Setup.  The CPU Unit will continue operating and the ERR/ALM indicator on the front of the CPU Unit will flash. <ul style="list-style-type: none"> <li>This flag can be used to control an external warning light or other indicator to indicate that the battery needs to be replaced.</li> <li>This flag will be turned OFF when the error is cleared.</li> </ul>	ON: Error OFF: No error	Cleared	Cleared	Refreshed when error occurs.	PLC Setup (Detect Battery Error)

Address		Name	Function	Settings	Status after mode change	Status at startup	Write timing	Related flags, settings
Words	Bits							
A402	10	PLC Setup Error Flag (non-fatal error)	ON when there is a setting error in the PLC Setup. The CPU Unit will continue operating and the ERR/ALM indicator on the front of the CPU Unit will flash.  <b>Note</b> This flag will be turned OFF when the error is cleared.	ON: Error OFF: No error	Cleared	Cleared	Refreshed when error occurs.	
	15	FAL Error Flag (non-fatal error)	ON when a non-fatal error is generated by executing FAL. The CPU Unit will continue operating and the ERR/ALM indicator on the front of the CPU Unit will flash.  The bit in A360 to A391 that corresponds to the FAL number specified in FALS will be turned ON and the corresponding error code will be written to A400. Error codes 4101 to 42FF correspond to FAL numbers 001 to 2FF (0 to 511).  <b>Note</b> This flag will be turned OFF when the error is cleared.	ON: FAL error occurred OFF: FAL not executed	Cleared	Cleared	Refreshed when error occurs.	A360 to A391, A400
A403	00 to 08	Memory Error Location	When a memory error occurs, the Memory Error Flag (A401.15) is turned ON and one of the following flags is turned ON to indicate the memory area where the error occurred A403.00: Ladder program A403.04: PLC Setup  When a memory error occurs, the CPU Unit will continue operating and the ERR/ALM indicator on the front of the CPU Unit will flash.  <b>Note</b> The corresponding flag will be turned OFF when the error is cleared.	ON: Error OFF: No error	Cleared	Cleared	Refreshed when error occurs.	A401.15
	10	Backup Memory Error Flag	ON when the built-in EEPROM backup memory is physically destroyed.	ON: Error OFF: No error	Cleared	Cleared	Refreshed when error is detected.	
A404		I/O Bus Error Details	Contains information on I/O bus errors. The CPU Unit will stop operating and the ERR/ALM indicator on the front of the CPU Unit will light.  <b>Note</b> A401.14 (I/O Bus Error Flag) will turn ON.	0A0A hex: Expansion Unit error	Cleared	Cleared	Refreshed when error is detected.	A401.14
A407	13 to 15	Too Many I/O Points, Cause	The 3-digit binary value of these bits indicates the cause of the Too Many I/O Points Error.	010: Too many Expansion Unit and Expansion I/O Unit words	Cleared	Cleared	Refreshed when error occurs.	A401.11
A424	00 to 15	Error Option Board Flags	The bit corresponding to the option slot turns ON when an error occurs in an Option Board (A315.13 will be ON). Bit 01: Option slot 2	ON: Error OFF: No error	Cleared	Cleared		A353.13
A434	0	Open-circuit Detection for Built-in Analog Input 0	On when AD0 open-circuit is detected		Retained	Cleared	Refreshed when AD0 open-circuit is detected.	
	1	Open-circuit Detection for Built-in Analog Input 1	On when AD1 open-circuit is detected		Retained	Cleared	Refreshed when AD1 open-circuit is detected.	
	4	Built-in Analog Initial Flag	ON when the built-in analog initialization is normally finished.		Retained	Cleared	Refreshed when built-in analog initialization is normally finished.	

Address		Name	Function	Settings	Status after mode change	Status at startup	Write timing	Related flags, settings
Words	Bits							
A435	15	I/O Option Board Run State Flag	Turn ON when the I/O Option Board works normally. Turn OFF when the I/O Option Board is in initial state or abnormality state.	ON: I/O option board works normally OFF: In initial state or abnormality state		Cleared	When I/O option board state changes.	
A436	00 to 02	Expansion Unit and Expansion I/O Unit Error Flags	ON when an error occurs in a CP-series Expansion Unit or Expansion I/O Unit.  A436.00: 1st Unit A436.01: 2nd Unit A436.02: 3rd Unit A436.03: 4th Unit A436.04: 5th Unit A436.05: 6th Unit  <b>Note</b> CP1W-TS002/TS003/TS102/AD041/AD042/DA041/DA042/32ER/32ET/32ET1 are each counted as two Units.	OFF: No error ON: Error	Retained	Cleared		
A437		Number of Connected Units	Stores the number of Expansion Units and Expansion I/O Units connected as a hexadecimal number.  <b>Note</b> This information is invalid only when a Too Many I/O Points error has occurred. CP1W-TS002/TS003/TS102/AD041/AD042/DA041/DA042/32ER/32ET/32ET1 are each counted as two Units.	0000 to 0006 hex	Retained	Cleared		
A440		Max. Interrupt Task Processing Time	Contains the Maximum Interrupt Task Processing Time in units of 0.1 ms.  <b>Note</b> This value is cleared when PLC operation begins.	0000 to FFFF hex	Cleared	Cleared	Written after the interrupt task with the max. processing time is executed.	
A441		Interrupt Task with Max. Processing Time	Contains the task number of the interrupt task with the maximum processing time. Hexadecimal values 8000 to 800F correspond to task numbers 00 to 0F. Bit 15 is turned ON when an interrupt has occurred.  <b>Note</b> This value is cleared when PLC operation begins.	8000 to 800F hex	Cleared	Cleared	Written after the interrupt task with the max. processing time is executed.	
A442		Total Interrupt Task Processing Time One Cycle	Contains the Total Interrupt Task Processing Time in one cycle in units of 0.1ms. Sets when the value is bigger than the last one once a cycle by common processing.  <b>Note</b> This value is cleared when PLC operation begins. The value is unstable for CPU Unit version 1.0 or earlier.	0000 to FFFF hex	Cleared	Cleared	Each cycle	A440
A444		Pulse Output 0 Stop Error Code	If a Pulse Output Stop Error occurs for pulse output 0, the error code is written to this word.		Retained	Cleared	<ul style="list-style-type: none"> <li>Refreshed when origin search starts.</li> <li>Refreshed when a pulse output stop error occurs.</li> </ul>	
A445		Pulse Output 1 Stop Error Code	If a Pulse Output Stop Error occurs for pulse output 1, the error code is written to this word.		Retained	Cleared	<ul style="list-style-type: none"> <li>Refreshed when origin search starts.</li> <li>Refreshed when a pulse output stop error occurs.</li> </ul>	

## A-2-2 Read/Write Words

Address		Name	Function	Settings	Status after mode change	Status at startup	Write timing	Related flags, settings
Words	Bits							
A500	12	IOM Hold Bit	Turn ON this bit to preserve the status of the I/O Memory when shifting from PROGRAM to RUN or MONITOR mode or vice versa.	ON: Retained OFF: Not retained	Retained	Not retained	Refreshed when power is turned ON.	
	13	Forced Status Hold Bit	Turn ON this bit to preserve the status of bits that have been force-set or force-reset when shifting from PROGRAM to MONITOR mode or vice versa. Always use this bit together with the IOM Hold Bit (A500.12), i.e., turn them ON at the same time.	ON: Retained OFF: Not retained	Retained	Not retained	Refreshed when power is turned ON.	
	14	Error Log Reset Bit	Turn this bit ON to reset the Error Log Pointer (A300) to 00.  <b>Note 1</b> The contents of the Error Log Area itself (A100 to A199) are not cleared. <b>2</b> This bit is automatically reset to 0 after the Error Log Pointer is reset.	OFF to ON: Clear	Retained	Cleared		A100 to A199, A300
	15	Output OFF Bit	Turn this bit ON to turn OFF all outputs from the CPU Unit, CP-series Expansion Units, and CP-series Expansion I/O Units. The INH indicator on the front of the CPU Unit will light while this bit is ON.  <b>Note</b> This bit is cleared when the power supply is turned OFF.		Retained	Cleared		
A508	09	Differentiate Monitor Completed Flag	ON when the differentiate monitor condition has been established during execution of differentiation monitoring.  <b>Note</b> This flag will be cleared to 0 when differentiation monitoring starts.	ON: Monitor condition established OFF: Not yet established	Retained	Cleared		
A510 to A511 (CP1E N/NA □□(S)-type CPU Unit only)	–	Startup Time	These words contain the time at which the power was turned ON. The contents are updated every time that the power is turned ON. The data is stored in BCD.  A510.00 to A510.07: Second (00 to 59) A510.08 to A510.15: Minute (00 to 59) A511.00 to A511.07: Hour (00 to 23) A511.08 to A511.15: Day of month (01 to 31)  <b>Note 1</b> The data will be unstable if the capacitor becomes discharged. <b>2</b> In an E□□(S)-type CPU Unit, or if the clock data is not set for an N/NA□□(S)-type CPU Unit, the data will be for 1:01.01 on Sunday January 1, 2001.	See Function column.	Retained	See Function column.	Refreshed when power is turned ON.	

Address		Name	Function	Settings	Status after mode change	Status at startup	Write timing	Related flags, settings
Words	Bits							
A512 to A513 (CP1E N/NA □□(S)-type CPU Unit only)	–	Power Interruption Time	<p>These words contain the time at which the power was interrupted. The contents are updated every time that the power is interrupted. The data is stored in BCD.</p> <p>A512.00 to A512.07: Second (00 to 59)</p> <p>A512.08 to A512.15: Minute (00 to 59)</p> <p>A513.00 to A513.07: Hour (00 to 23)</p> <p>A513.08 to A513.15: Day of month (01 to 31)</p> <p><b>Note 1</b> These words are not cleared at startup.</p> <p><b>2</b> The data will be unstable if the capacitor becomes discharged.</p> <p><b>3</b> In an E□□(S)-type CPU Unit, or if the clock data is not set for an N/NA□□(S)-type CPU Unit, the data will be for 1:01.01 on Sunday January 1, 2001.</p>	See Function column.	Retained	Retained	Written at power interruption.	
A514	–	Number of Power Interruptions	<p>Contains the number of times that power has been interrupted since the power was first turned ON. The data is stored in binary. To reset this value, overwrite the current value with 0000.</p> <p><b>Note</b> The data will be unstable if the capacitor becomes discharged.</p>	0000 to FFFF hex	Retained	Retained	Refreshed when power is turned ON.	
A515 to A517 (CP1E N/NA □□(S)-type CPU Unit only)	–	Operation Start Time	<p>The time that operation started as a result of changing the operating mode to RUN or MONITOR mode is stored here in BCD.</p> <p>A515.00 to A515.07: Seconds (00 to 59)</p> <p>A515.08 to A515.15: Minutes (00 to 59)</p> <p>A516.00 to A516.07: Hour (00 to 23)</p> <p>A516.08 to A516.15: Day of month (01 to 31)</p> <p>A517.00 to A517.07: Month (01 to 12)</p> <p>A517.08 to A517.15: Year (00 to 99)</p> <p><b>Note 1</b> The previous start time is stored after turning ON the power supply until operation is started.</p> <p><b>2</b> The data will be unstable if the capacitor becomes discharged.</p> <p><b>3</b> In an E□□(S)-type CPU Unit, or if the clock data is not set for an N/NA□□(S)-type CPU Unit, the data will be for 1:01.01 on Sunday January 1, 2001.</p>	See at left.	Retained	Retained	See at left.	

Address		Name	Function	Settings	Status after mode change	Status at startup	Write timing	Related flags, settings
Words	Bits							
A518 to A520 (CP1E N/NA □□(S)-type CPU Unit only)	–	Operation End Time	<p>The time that operation stopped as a result of changing the operating mode to PROGRAM mode is stored here in BCD.</p> <p>A518.00 to A518.07: Seconds (00 to 59)                      A518.08 to A518.15: Minutes (00 to 59)                      A519.00 to A519.07: Hour (00 to 23)                      A519.08 to A519.15: Day of month (01 to 31)                      A520.00 to A520.07: Month (01 to 12)                      A520.08 to A520.15: Year (00 to 99)</p> <p><b>Note 1</b> If an error occurs in operation, the time of the error will be stored. If the operating mode is then changed to PROGRAM mode, the time that PROGRAM mode was entered will be stored.</p> <p><b>2</b> The data will be unstable if the capacitor becomes discharged.</p> <p><b>3</b> In an E□□(S)-type CPU Unit, or if the clock data is not set for an N/NA□□(S)-type CPU Unit, the data will be for 1:01.01 on Sunday January 1, 2001.</p>	See at left.	Retained	Retained	See at left.	
A525	01	Ethernet Option Board Reset Flag (Serial Option Port)	Turn ON this bit to reset the Ethernet Option Board mounted on the serial Option port.	OFF to ON: Reset	Retained	Cleared		
	09	Ethernet Option Board Restart Flag (Serial Option Port)	Turn ON this bit to restart Ethernet Option Board mounted on the serial Option port.	OFF to ON: Restart	Retained	Cleared		
A526	00	Built-in RS-232C Port Restart Bit (CP1E N/NA□□(S)-type CPU Unit only)	Turn ON this bit to restart the built-in RS-232C port. <b>Note</b> This bit is turned OFF automatically when the restart processing is completed.	OFF to ON: Restart	Retained	Cleared		
	01	Serial Option Port/ Bult-in RS-485 Port Restart Bit (CP1E N30/40/60(S□) or NA20 CPU Unit only)	Turn ON this bit to restart the serial option port or built-in RS-485 port. <b>Note</b> This bit is turned OFF automatically when the restart processing is completed.	OFF to ON: Restart port	Retained	Cleared		

Address		Name	Function	Settings	Status after mode change	Status at startup	Write timing	Related flags, settings
Words	Bits							
A528	00 to 07	Built-in RS-232C Port/ Built-in RS-485 Port Error Flags (CP1E N/NA□□(S)-type CPU Unit only)	<p>These flags indicate what kind of error has occurred at the built-in RS-232C port.</p> <ul style="list-style-type: none"> <li>They are automatically turned OFF when the built-in RS-232C port is restarted.</li> <li>Only bit 5 (timeout error) is valid in NT Link mode.</li> <li>Serial PLC Link Polling Unit: Bit 05: ON for timeout error. Serial PLC Link Polled Unit: Bit 03: ON for framing error. Bit 04: ON for overrun error. Bit 05: ON for timeout error.</li> </ul> <p>These bits can be cleared by the CX-Programmer.</p>	<p>Bits 00 and 01: Not used.</p> <p>Bit 02: ON for parity error.</p> <p>Bit 03: ON for framing error.</p> <p>Bit 04: ON for overrun error.</p> <p>Bit 05: ON for timeout error.</p> <p>Bits 06 and 07: Not used.</p>	Retained	Cleared		
	08 to 15	Serial Option Port/ Built-in RS-485 Port Error Flags (CP1E N30/40/60(S□) or NA20 CPU Unit only)	<p>These flags indicate what kind of error has occurred at the serial option port or built-in RS-485 port.</p> <ul style="list-style-type: none"> <li>They are automatically turned OFF when the serial option port or built-in RS-485 port is restarted.</li> <li>Only bit 5 (timeout error) is valid in NT Link mode.</li> <li>Serial PLC Link Polling Unit: Bit 13: ON for timeout error. Serial PLC Link Polled Unit: Bit 11: ON for framing error. Bit 12: ON for overrun error. Bit 13: ON for timeout error.</li> </ul> <p>These bits can be cleared by the CX-Programmer.</p>	<p>Bits 08 and 09: Not used.</p> <p>Bit 10: ON for parity error.</p> <p>Bit 11: ON for framing error.</p> <p>Bit 12: ON for overrun error.</p> <p>Bit 13: ON for timeout error.</p> <p>Bits 14 and 15: Not used.</p>	Retained	Cleared		
A529		FAL/FALS Number for System Error Simulation	<p>Set a dummy FAL/FALS number to use to simulate the system error using FAL or FALS.</p> <p><b>Note</b> When FAL or FALS is executed and the number in A529 is the same as the one specified in the operand of the instruction, the system error given in the operand of the instruction will be generated instead of a user-defined error.</p>	<p>0001 to 01FF hex: FAL/FALS numbers 1 to 511</p> <p>0000 or 0200 to FFFF hex: No FAL/FALS number for system error simulation. (No error will be generated.)</p>	Retained	Cleared		
A531	00	High-speed Counter 0 Reset Bit	<p>When the reset method is set to Phase-Z signal + Software reset, the corresponding high-speed counter's PV will be reset if the phase-Z signal is received while this bit is ON.</p> <p>When the reset method is set to Software reset, the corresponding high-speed counter's PV will be reset in the cycle when this bit turns ON.</p>		Retained	Cleared		
	01	High-speed Counter 1 Reset Bit						
	02	High-speed Counter 2 Reset Bit						
	03	High-speed Counter 3 Reset Bit						
	04	High-speed Counter 4 Reset Bit						
	05	High-speed Counter 5 Reset Bit (Not supported by E10 CPU Unit)						

Address		Name	Function	Settings	Status after mode change	Status at startup	Write timing	Related flags, settings
Words	Bits							
A540	00	Pulse Output 0 Reset Bit	The pulse output 0 PV (contained in A276 and A277) will be cleared when this bit is turned ON.		Retained	Cleared		A276 and A277
	08	Pulse Output 0 CW Limit Input Signal Flag	This is the CW limit input signal for pulse output 0, which is used in the origin search. To use this signal, write the input from the actual sensor as an input condition in the ladder program and output the result to this flag.		Retained	Cleared		
	09	Pulse Output 0 CCW Limit Input Signal Flag	This is the CCW limit input signal for pulse output 0, which is used in the origin search. To use this signal, write the input from the actual sensor as an input condition in the ladder program and output the result to this flag.		Retained	Cleared		
	10	Pulse Output 0 Positioning Completed Signal	This is the positioning completed input signal used in the origin search for pulse output 0. The input signal from the servo driver is output to this bit from the ladder program to enable using the signal.		Retained	Cleared		
A541	00	Pulse Output 1 Reset Bit	The pulse output 1 PV (contained in A278 and A279) will be cleared when this bit is turned ON.		Retained	Cleared		A278 and A279
	08	Pulse Output 1 CW Limit Input Signal Flag	This is the CW limit input signal for pulse output 1, which is used in the origin search. To use this signal, write the input from the actual sensor as an input condition in the ladder program and output the result to this flag.		Retained	Cleared		
	09	Pulse Output 1 CCW Limit Input Signal Flag	This is the CCW limit input signal for pulse output 1, which is used in the origin search. To use this signal, write the input from the actual sensor as an input condition in the ladder program and output the result to this flag.		Retained	Cleared		
	10	Pulse Output 1 Positioning Completed Signal	This is the positioning completed input signal used in the origin search for pulse output 1. The input signal from the servo driver is output to this bit from the ladder program to enable using the signal.		Retained	Cleared		



Address		Name	Function	Settings	Status after mode change	Status at startup	Write timing	Related flags, settings
Words	Bits							
A617	00	Built-in RS232C Port Communication Settings	Display the present communication settings of the built-in RS232C port. Reflect the PLC Setup when power is turned ON.	Parity 0: Even 1: Odd	Retained	See Function column.	Refreshed when power is turned ON.	
	01			Parity 0: Yes 1: No	Retained	See Function column.	Refreshed when power is turned ON.	
	02			Stop bit 0: 2 bits 1: 1 bit	Retained	See Function column.	Refreshed when power is turned ON.	
	03			Data length 0: 7 bits 1: 8 bits	Retained	See Function column.	Refreshed when power is turned ON.	
	04			Start bit 0: 1 bit (fixed)	Retained	See Function column.	Refreshed when power is turned ON.	
	08 to 11			Communication speed 0 hex: Default (9600) 3 hex: 1200 4 hex: 2400 5 hex: 4800 6 hex: 9600 7 hex: 19200 8 hex: 38400 9 hex: 57600 A hex: 115200	Retained	See Function column.	Refreshed when power is turned ON.	
	12 to 15			Communication mode 0 hex: Default (Host Link) 2 hex: NT link (1: N) 3 hex: Non-protocol 5 hex: Host Link 7 hex: Serial PLC Link (Slave) 8 hex: Serial PLC Link (Master) 9 hex: Modbus-RTU Easy Master	Retained	See Function column.	Refreshed when power is turned ON.	
A618	00	Serial Option Port/ Built-in RS-485 port Communication Settings	Display the present communication settings of the serial option port or built-in RS-485 port. Reflect the PLC Setup when power is turned ON.	Parity 0: Even 1: Odd	Retained	See Function column.	Refreshed when power is turned ON.	
	01			Parity 0: Yes 1: No	Retained	See Function column.	Refreshed when power is turned ON.	
	02			Stop bit 0: 2 bits 1: 1 bit	Retained	See Function column.	Refreshed when power is turned ON.	
	03			Data length 0: 7 bits 1: 8 bits	Retained	See Function column.	Refreshed when power is turned ON.	
	04			Start bit 0: 1 bit (fixed)	Retained	See Function column.	Refreshed when power is turned ON.	

Address		Name	Function	Settings	Status after mode change	Status at startup	Write timing	Related flags, settings
Words	Bits							
A618	08 to 11	Serial Option Port Communication Settings	Display the present communication settings of the serial option port. Reflect the PLC Setup when power is turned ON.	Communication speed 0 hex: Default (9600) 3 hex: 1200 4 hex: 2400 5 hex: 4800 6 hex: 9600 7 hex: 19200 8 hex: 38400 9 hex: 57600 A hex: 115200	Retained	See Function column.	Refreshed when power is turned ON.	
	12 to 15			Communication mode 0 hex: Default (Host Link) 2 hex: NT link(1: N) 3 hex: Non-protocol 5 hex: Host Link 7 hex: Serial PLC Link (Slave) 8 hex: Serial PLC Link (Master) 9 hex: Modbus-RTU Easy Master	Retained	See Function column.	Refreshed when power is turned ON.	
A640	00	Built-in RS-232C Port Modbus-RTU Easy Master Execution Bit (CP1E N/NA□□(S)-type CPU Unit only)	Turn ON this bit to send a command and receive a response for the built-in RS-232C port using the Modbus-RTU easy master function. <b>Note</b> This bit will be turned OFF automatically by the system when communications have been completed.	Turned ON: Execution started ON: Execution in progress. OFF: Not executed or execution completed.	Retained	Cleared		DM Area words for built-in RS-232C port Modbus-RTU Easy Master: D01200 to D01299
	01	Built-in RS-232C Port Modbus-RTU Easy Master Normal End Flag (CP1E N/NA-□□(S) type CPU Unit only)	ON when one command has been sent and the response received for the built-in RS-232C port using the Modbus-RTU easy master function.	ON: Execution normal. OFF: Execution error or still in progress.	Retained	Cleared		
	02	Built-in RS-232C Port Modbus-RTU Easy Master Error End Flag (CP1E N/NA□□(S)-type CPU Unit only)	ON when an error has occurred in communications for the built-in RS-232C port using the Modbus-RTU easy master function. The error code is output to D01252 in the DM fixed allocation words for Modbus-RTU Easy Master.	ON: Execution error. OFF: Execution normal or still in progress.	Retained	Cleared		
A641	00	Serial Option Port/ Built-in RS-485 Port Modbus-RTU Master Execution Bit (CP1E N30/40/60(S□) or NA20 CPU Unit only)	Turn ON this bit to send a command and receive a response for the serial option port or built-in RS-485 port using the Modbus-RTU easy master function. <b>Note</b> This bit will be turned OFF automatically by the system when communications have been completed.	Turned ON: Execution started ON: Execution in progress. OFF: Not executed or execution completed.	Retained	Cleared		DM Area words for built-in RS-232C port Modbus-RTU Easy Master: D01300 to D01399
	01	Serial Option Port/ Built-in RS-485 Port Modbus-RTU Master Execution Normal Flag (CP1E N30/40/60(S□) or NA20 CPU Unit only)	ON when one command has been sent and the response received for the serial option port or built-in RS-485 port using the Modbus-RTU easy master function.	ON: Execution normal. OFF: Execution error or still in progress.	Retained	Cleared		
	02	Serial Option Port/ Built-in RS-485 Port Modbus-RTU Master Execution Error Flag (CP1E N30/40/60(S□) or NA20 CPU Unit only)	ON when an error has occurred in communications for the serial option port or built-in RS-485 port using the Modbus-RTU easy master function. The error code is output to D01352 in the DM fixed allocation words for Modbus-RTU Easy Master.	ON: Execution error. OFF: Execution normal or still in progress.	Retained	Cleared		

Address		Name	Function	Settings	Status after mode change	Status at startup	Write timing	Related flags, settings
Words	Bits							
A642		Analog Adjustment 1 PV	Stores the value set on analog adjuster 1 as a hexadecimal value.	0000 to 00FF hex	Retained	Cleared		
A643		Analog Adjustment 2 PV	Stores the value set on analog adjuster 2 as a hexadecimal value.	0000 to 00FF hex	Retained	Cleared		
A720 to A722 (CP1E N/NA □□(S) -type CPU Unit only)		Power ON Clock Data 1	<p>These words contain the time at which the power was turned ON one time before the startup time stored in words A510 to A511.</p> <p>A720.00 to A720.07: Seconds (00 to 59) A720.08 to A720.15: Minutes (00 to 59) A721.00 to A721.07: Hour (00 to 23) A721.08 to A721.15: Day of month (01 to 31) A722.00 to A722.07: Month (01 to 12) A722.08 to A722.15: Year (00 to 99)</p> <p><b>Note 1</b> All of the clock data from A720 to A749 is cleared if the capacitor becomes discharged.</p> <p><b>2</b> In an E□□(S)-type CPU Unit, or if the clock data is not set for an N/NA□□(S)-type CPU Unit, the data will be for 1:01.01 on Sunday January 1, 2001.</p>	See at left.	Retained	Retained	Written when power is turned ON.	
A723 to A725 (CP1E N/NA □□(S) -type CPU Unit only)		Power ON Clock Data 2	<p>These words contain the time at which the power was turned ON two times before the startup time stored in words A510 to A511.</p> <p>A723.00 to A723.07: Seconds (00 to 59) A723.08 to A723.15: Minutes (00 to 59) A724.00 to A724.07: Hour (00 to 23) A724.08 to A724.15: Day of month (01 to 31) A725.00 to A725.07: Month (01 to 12) A725.08 to A725.15: Year (00 to 99)</p>	See at left.	Retained	Retained	Written when power is turned ON.	
A726 to A728 (CP1E N/NA □□(S) -type CPU Unit only)		Power ON Clock Data 3	<p>These words contain the time at which the power was turned ON three times before the startup time stored in words A510 to A511.</p> <p>A726.00 to A726.07: Seconds (00 to 59) A726.08 to A726.15: Minutes (00 to 59) A727.00 to A727.07: Hour (00 to 23) A727.08 to A727.15: Day of month (01 to 31) A728.00 to A728.07: Month (01 to 12) A728.08 to A728.15: Year (00 to 99)</p>	See at left.	Retained	Retained	Written when power is turned ON.	
A729 to A731 (CP1E N/NA □□(S) -type CPU Unit only)		Power ON Clock Data 4	<p>These words contain the time at which the power was turned ON four times before the startup time stored in words A510 to A511.</p> <p>A729.00 to A729.07: Seconds (00 to 59) A729.08 to A729.15: Minutes (00 to 59) A730.00 to A730.07: Hour (00 to 23) A730.08 to A730.15: Day of month (01 to 31) A731.00 to A731.07: Month (01 to 12) A731.08 to A731.15: Year (00 to 99)</p>	See at left.	Retained	Retained	Written when power is turned ON.	

Address		Name	Function	Settings	Status after mode change	Status at startup	Write timing	Related flags, settings
Words	Bits							
A732 to A734 (CP1E N/NA □□(S) -type CPU Unit only)		Power ON Clock Data 5	These words contain the time at which the power was turned ON five times before the startup time stored in words A510 to A511.  A732.00 to A732.07: Seconds (00 to 59) A732.08 to A732.15: Minutes (00 to 59) A733.00 to A733.07: Hour (00 to 23) A733.08 to A733.15: Day of month (01 to 31) A734.00 to A734.07: Month (01 to 12) A734.08 to A734.15: Year (00 to 99)	See at left.	Retained	Retained	Written when power is turned ON.	
A735 to A737 (CP1E N/NA □□(S) -type CPU Unit only)		Power ON Clock Data 6	These words contain the time at which the power was turned ON six times before the startup time stored in words A510 to A511.  A735.00 to A735.07: Seconds (00 to 59) A735.08 to A735.15: Minutes (00 to 59) A736.00 to A736.07: Hour (00 to 23) A736.08 to A736.15: Day of month (01 to 31) A737.00 to A737.07: Month (01 to 12) A737.08 to A737.15: Year (00 to 99)	See at left.	Retained	Retained	Written when power is turned ON.	
A738 to A740 (CP1E N/NA □□(S) -type CPU Unit only)		Power ON Clock Data 7	These words contain the time at which the power was turned ON seven times before the startup time stored in words A510 to A511.  A738.00 to A738.07: Seconds (00 to 59) A738.08 to A738.15: Minutes (00 to 59) A739.00 to A739.07: Hour (00 to 23) A739.08 to A739.15: Day of month (01 to 31) A740.00 to A740.07: Month (01 to 12) A740.08 to A740.15: Year (00 to 99)	See at left.	Retained	Retained	Written when power is turned ON.	
A741 to A743 (CP1E N/NA □□(S) -type CPU Unit only)		Power ON Clock Data 8	These words contain the time at which the power was turned ON eight times before the startup time stored in words A510 to A511.  A741.00 to A741.07: Seconds (00 to 59) A741.08 to A741.15: Minutes (00 to 59) A742.00 to A742.07: Hour (00 to 23) A742.08 to A742.15: Day of month (01 to 31) A743.00 to A743.07: Month (01 to 12) A743.08 to A743.15: Year (00 to 99)	See at left.	Retained	Retained	Written when power is turned ON.	
A744 to A746 (CP1E N/NA □□(S) -type CPU Unit only)		Power ON Clock Data 9	These words contain the time at which the power was turned ON nine times before the startup time stored in words A510 to A511.  A744.00 to A744.07: Seconds (00 to 59) A744.08 to A744.15: Minutes (00 to 59) A745.00 to A745.07: Hour (00 to 23) A745.08 to A745.15: Day of month (01 to 31) A746.00 to A746.07: Month (01 to 12) A746.08 to A746.15: Year (00 to 99)	See at left.	Retained	Retained	Written when power is turned ON.	

Address		Name	Function	Settings	Status after mode change	Status at startup	Write timing	Related flags, settings
Words	Bits							
A747 to A749 (CP1E N/NA-type CPU Unit only)		Power ON Clock Data 10	<p>These words contain the time at which the power was turned ON ten times before the startup time stored in words A510 to A511.</p> <p>A747.00 to A747.07: Seconds (00 to 59)                      A747.08 to A747.15: Minutes (00 to 59)                      A748.00 to A748.07: Hour (00 to 23)                      A748.08 to A748.15: Day of month (01 to 31)                      A749.00 to A749.07: Month (01 to 12)                      A749.08 to A749.15: Year (00 to 99)</p>	See at left.	Retained	Retained	Written when power is turned ON.	
A751.11		DM Backup Restore Failed Flag	ON when DM backup data could not be restored normally. If this flag turns ON, data will not be restored from the built-in EEPROM backup memory to RAM.		Retained	Cleared		
A751.14		DM Backup Save Flag	ON when A751.15 is turned ON to start the saving operation. This flag stays ON while data is being saved and turns OFF when finished.		Retained	Cleared		
A751.15		DM Backup Save Start Bit	<p>Saving the specified words from the DM Area in RAM to the built-in EEPROM backup memory is started when this bit is turned ON.</p> <p>This bit will not turn OFF automatically even when saving the data has been completed.</p> <p>If this bit is turned ON and OFF while the DM Backup Save Flag (A751.14) is ON, it will be ignored and the data will not be backed up again.</p> <p><b>Note</b> Select the <i>Restore D0- from backup memory</i> Check Box and set the number of DM Area words to back up in the <i>Number of CH of DM for backup</i> Box in the PLC Setup before using this bit.</p>	<p>ON: Start saving.</p> <p>OFF: Execution normal or still in progress.</p>	Retained	Cleared		

# A-3 Response Performance

## A-3-1 I/O Response Time

The I/O response time is the time it takes from when an input turns ON, the data is recognized by the CPU Unit, and the ladder programs are executed, up to the time for the result to be output to an output terminal.

The length of the I/O response time depends on the following conditions.

- Timing of Input Bit turning ON.
- The cycle time

### ● Minimum I/O Response Time

The I/O response time is shortest when data is retrieved immediately before I/O refresh of the CPU Unit.

The minimum I/O response time is calculated as follows:

$$\text{Minimum I/O response time} = \text{Input ON delay} + \text{Cycle time} + \text{Output ON delay}$$

**Note** The input and output ON delays depend on the type of terminals used on the CPU Unit or the model number of the Unit being used.

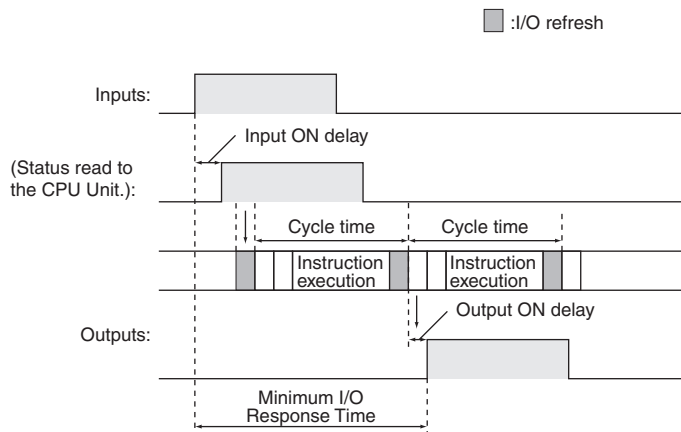

### ● Maximum I/O Response Time

The I/O response time is longest when data is retrieved immediately after I/O refresh period of the CPU Unit.

The maximum I/O response time is calculated as follows:

$$\text{Maximum I/O response time} = \text{Input ON delay} + (\text{Cycle time} \times 2) + \text{Output ON delay}$$

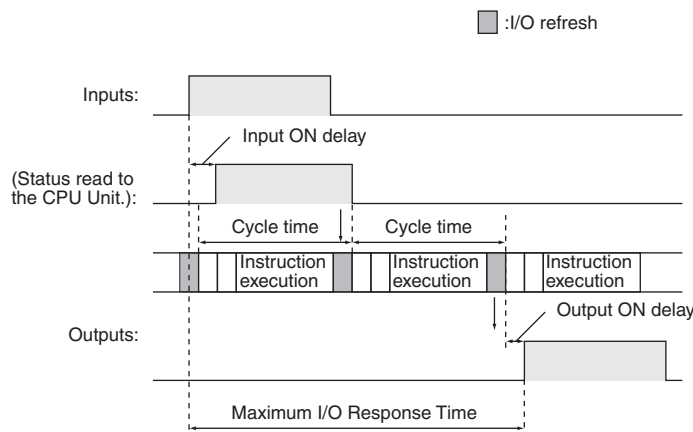

● **Calculation Example**

Conditions:

Input ON delay: 1 ms (normal input 0.08 to 0.11 with input constant set to 0 ms)

Output ON delay: 0.1 ms (transistor output)

Cycle time: 20 ms

Minimum I/O response time = 1 ms + 20 ms + 0.1 ms = 21.1 ms

Maximum I/O response time = 1 ms + (20 ms × 2) + 0.1 ms = 41.1 ms

**Input Constant Setting**

Input constant setting can be set in the PLC Setup.

Increasing the input constants slows the input response time and reduces the effects of chattering and noise. Decreasing the input constants fasters the input response time and allows reception of shorter input pulses (but the pulse width must be longer than the cycle time).

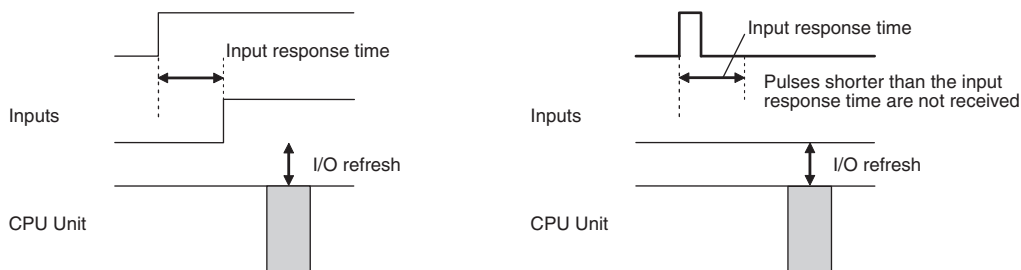

● **PLC Setup**

Name	Description	Setting	Default
Input Constant Settings	Input Constants	00 hex: 8 ms 10 hex: No filter (0 ms) 12 hex: 1 ms 13 hex: 2 ms 14 hex: 4 ms 15 hex: 8 ms 16 hex: 16 ms 17 hex: 32 ms	00 hex (8 ms)

**Note** The input constants of CP1W-40EDR/EDT/EDT1 are always 16ms regardless of the settings.

## A-3-2 Interrupt Response Time

### ● Interrupt Response Time for Input Interrupt Tasks

The interrupt response time for input interrupt tasks is the time taken from when a built-in input has turned ON (or OFF) until the input interrupt task has actually been executed.

The length of the interrupt response time for input interrupt tasks depends on the total of the hardware interrupt response time and software interrupt response time.

Item	Interrupt response time	Counter 0,1,2 interrupts	Counter 3,4,5 interrupts
Hardware interrupt response time	Upward differentiation: 50 $\mu$ s	–	–
	Downward differentiation: 50 $\mu$ s	–	–
Software interrupt response time	Minimum: 70 $\mu$ s	Minimum: 120 $\mu$ s	Minimum: 150 $\mu$ s
	Maximum: 160 $\mu$ s + Wait time*	Maximum: 230 $\mu$ s + Wait time*	Maximum: 670 $\mu$ s + Wait time*

\* The wait time occurs when there is competition with other interrupts. As a guideline, the wait time will be 0 to 3 ms.

**Note** Input interrupt tasks can be executed during execution of the user program, I/O refresh, peripheral servicing, or overseeing. (Even if an instruction is being executed, execution of the instruction will be stopped to execute the interrupt task.)

The interrupt response time is not affected by the above processing operations during which the interrupt inputs turns ON.

Input interrupts, however, are not executed during execution of other interrupt tasks even if the input interrupt conditions are satisfied. Instead, the input interrupts are executed after the current interrupt task has completed execution and the software interrupt response time has elapsed.

The interrupt response time of input interrupt tasks is calculated as follows:

Interrupt response time = Input ON delay + Software interrupt response time

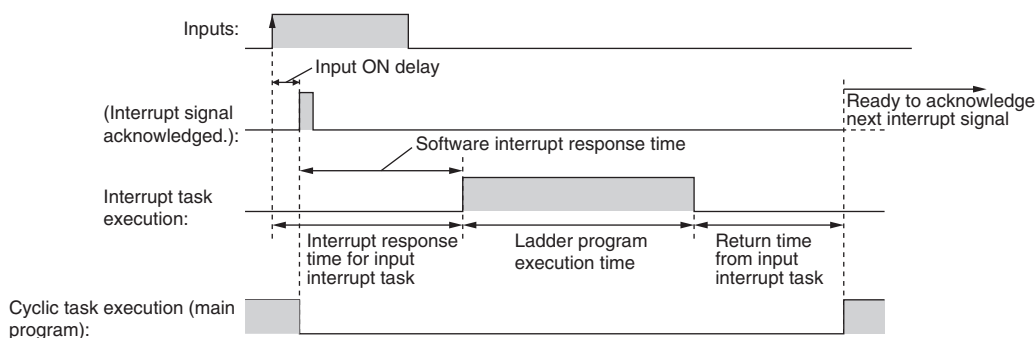

The time from when execution of the input interrupt task is completed until execution of the cyclic task is resumed is 24  $\mu$ s.



### ● Interrupt Response Time for Scheduled Interrupt Tasks

The interrupt response time for scheduled interrupt tasks is the time taken from after the scheduled time specified by the MSKS instruction has elapsed until the interrupt task has actually been executed.

The length of the interrupt response time for scheduled interrupt tasks is 0.1 ms max.

There is also an error of 10 μs in the time to the first scheduled interrupt (1.0 ms min.).

**Note** Scheduled interrupt tasks can be executed during execution of the ladder program (even while an instruction is being executed by stopping the execution of an instruction), I/O refresh, peripheral servicing, or overseeing. The processing operation in which the scheduled interrupt occurs does not affect the interrupt processing time.

Scheduled interrupts, however, are not executed during execution of other interrupt tasks even if the interrupt conditions are satisfied. Instead, the interrupts are executed in order of priority after the current interrupt task has completed execution and the software interrupt response time has elapsed. As a guideline, the wait time will be 0 to 3ms.

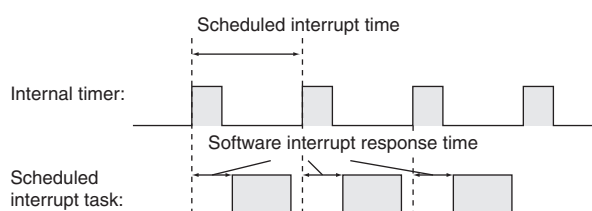

#### Precautions for Correct Use

The scheduled task will not be executed while the CPU Unit suspends operation for online editing.

## A-3-3 Serial PLC Link Response Performance

The response times for CPU Units connected via a Serial PLC Link (polling unit to polled unit or polled unit to polling unit) can be calculated as shown below.

**Note** A PT cannot be used in the Serial PLC Link.

- Maximum I/O response time (not including hardware delay) =  
Polling unit cycle time + Communications cycle time + Polled unit cycle time + 4 ms
- Minimum I/O response time (not including hardware delay) =  
Polled unit communications time + 0.8 ms

Number of participating polled unit nodes	The number of polled units to which links have been established within the maximum unit number set in the polling unit.
Number of non-participating polled unit nodes	The number of polled units not participating in the links within the maximum unit number set in the polling unit.
Communications cycle time (ms)	Polled unit communications time × Number of participating polled unit nodes + 10 × Number of non-participating polled unit nodes + 20 × Number of polled unit nodes
Polled unit communications time (ms)	<ul style="list-style-type: none"> <li>• Communications time set to <i>Standard</i>: <math>0.4 + 0.286 \times [(No. \text{ of polled units} + 1) \times No. \text{ of link words} \times 2 + 12]</math></li> <li>• Communications time set to <i>Fast</i>: <math>0.4 + 0.0955 \times [(No. \text{ of polled units} + 1) \times No. \text{ of link words} \times 2 + 12]</math></li> </ul>

### A-3-4 Pulse Output Start Time

The pulse output start time is the time required from executing a pulse output instruction until pulses are output externally.

This time depends on the pulse output instruction that is used and operation that is performed.

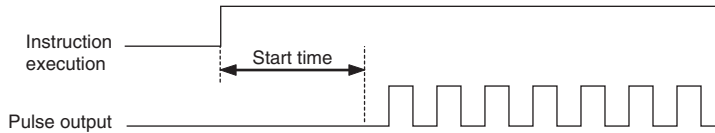

Pulse output instruction	Start time
SPED: continuous	Minimum: 500μs + Wait time*
SPED: independent	
ACC: continuous	
ACC: independent, trapezoidal	
ACC: independent, triangular	
PLS2: trapezoidal	
PLS2: triangular	

\* The wait time occurs when there is competition with other interrupts. As a guideline, the wait time will be 0 to 3 ms.

### A-3-5 Pulse Output Change Response Time

The pulse output change response time is the time for any change made by executing an instruction during pulse output to actually affect the pulse output operation.

Pulse output instruction	Change response time
INI: immediate stop	Minimum: 100μs + Wait time <sup>*1</sup> + 1 pulse output time
SPED: immediate stop	
ACC: deceleration stop	1 control cycle (4 ms) minimum, 2 control cycles (8 ms) maximum <sup>*2</sup>
PLS2: deceleration stop	
SPED: speed change	
ACC: speed change	
PLS2: target position change in reverse direction	
PLS2: target position change in same direction at same speed	
PLS2: target position change in same direction at different speed	

\*1 The wait time occurs when there is competition with other interrupts. As a guideline, the wait time will be 0 to 3 ms.

\*2 When the frequency of pulse output is lower than 250Hz, 1 control cycle will be equal to the time of pulse output.

Example: The change response time of 100Hz pulse output is above 1 control cycle (10ms) and below 2 control cycles (20ms).

# A-4 PLC Operation for Power Interruptions

## Overview of Operation for Power Interruptions

### ● Power Supply Voltage Drop

If the power supply voltage falls below the specified value (85% of rated voltage) while the CPU Unit is in RUN or MONITOR mode, operation will be stopped and all outputs will be turned OFF.

### ● Detection of Momentary Power Interruptions

The system will continue to run if the momentary power interruption lasts less than 10 ms (2ms for DC power supply). If power is interrupted for longer than 10 ms (2ms for DC power supply), a momentary power interruption will be detected or undetected. If the momentary power interruption is detected, the CPU Unit will be stopped and outputs will be turned OFF.

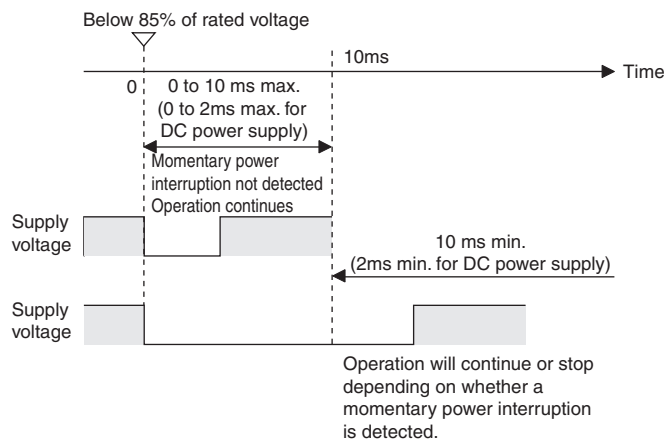

### ● Automatic Recovery

Operation is automatically restarted when the power supply voltage is restored.

## Power OFF Timing Chart

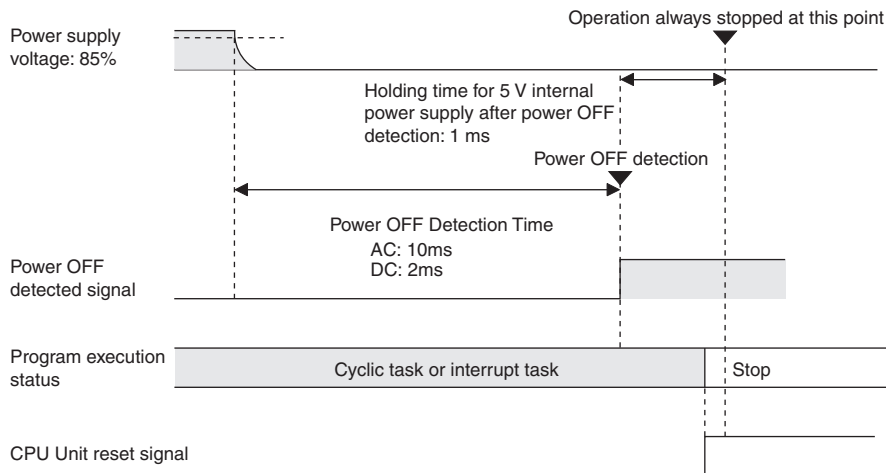

**Power OFF Detection Time:** The time from when the power supply voltage drops to 85% or less the rated voltage until the power interruption is detected.

**Power Holding Time:** The maximum amount of time (fixed at 1 ms) that 5 V will be held internally after power shuts OFF.

### ● Description of Operation

The power interruption will be detected if the 100 to 240 VAC power supply falls below 85% of the minimum rated voltage for the power OFF detection time (10 ms minimum for AC power supply and 2ms minimum for DC power supply, not fixed).

The CPU reset signal will turn ON and the CPU Unit will be reset immediately.

## Instruction Execution for Power Interruptions

The power OFF detection time of CP1E CPU Units is 10 ms minimum for AC power supply and 2ms minimum for DC power supply. If the power interruption is detected when operating in RUN or MONITOR mode, the instruction currently being executed will be stopped and then the CPU Unit will be reset.

## Malfunction Countermeasures

If only a couple of Expansion I/O Units or Expansion Units are connected to the CPU Unit resulting in a light power supply circuit load and a small current consumption, the time required by the CPU Unit to detect a power interruption will be longer. For this reason, inputs may be incorrectly identified as being OFF if external power supply used for an input turns OFF before the power interruption is detected. If an external NC contact input is used or the ladder program counts the number of ON to OFF transitions, a malfunction may occur if the external power supply turns OFF.

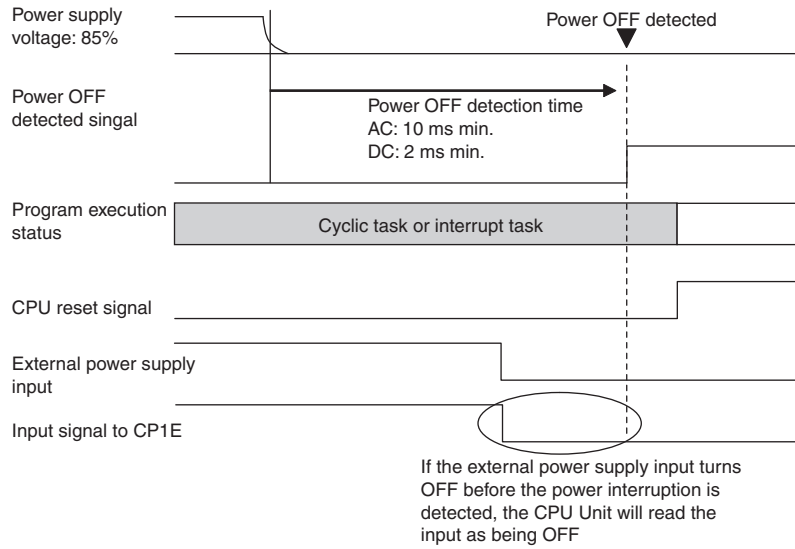

The following diagram shows an example countermeasure for this situation.

- Wiring

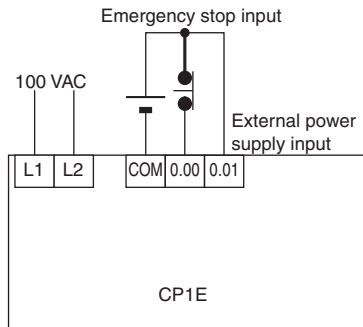

- Ladder Program

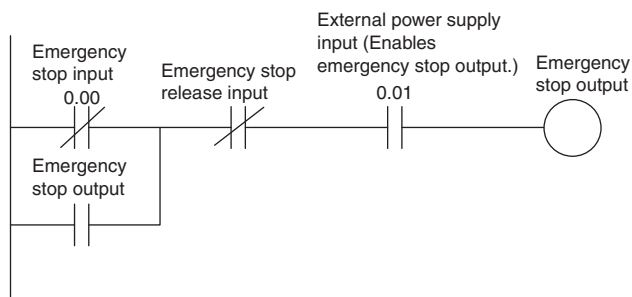



# Index

## Symbols

- \*D(Specifying indirect addresses in BCD Mode).....4-13, 5-12
- @D(Specifying indirect addresses in Binary Mode).....4-13, 5-12

## Numerics

- 1:N NT Links .....14-3, 14-5

## A

- Absolute coordinates .....12-13
- Absolute positioning.....12-13
- ACC instruction.....12-11, 12-17
- Access Error Flag(P\_AER) .....5-19
- Allocated words
  - CPU Unit .....6-3
  - Expansion I/O Unit .....6-4
- Allocating functions to built-in input terminals.....8-6
- Allocating functions to built-in output terminals.....8-8
- Allocations for Expansion I/O Units.....6-4
- Allocations for Expansion Units .....6-6
- Always OFF Flag(P\_Off).....5-19
- Always ON Flag(P\_On).....5-19
- Analog I/O Option Board.....18-15
- Analog Input Option Board.....18-7
- Analog Output Option Board.....18-11
- Automatic I/O comment creation.....19-14
- Automatic symbol name creation.....19-14
- Auxiliary Area.....5-4, 5-17

## B

- Backing up memory .....3-5
- Backup .....5-12
  - Backup area .....3-5
  - I/O memory backup time .....3-7
- Backup memory .....3-6, 16-8
- Backup time .....1-2
- Bit addresses .....5-5
- Built-in EEPROM .....2-2, 2-3, 3-6, 5-12, 16-8
- Built-in RAM.....1-5, 2-2, 2-3
- Built-in RS-232C Port.....7-5

## C

- C Mode command.....14-4, 14-31
- Carry Flag(P\_CY) .....5-19
- CIO Area .....5-2, 5-7
  - Allocation.....6-2
- Circular (Ring) mode(high-speed counter).....11-11
- Clock function .....16-7
- Clock Pulses .....5-4, 5-21
- Communications settings.....7-5, 7-8
- Condition Flags.....5-4, 5-19
- Connecting the Servo Drive and external sensors.....12-6
- Constants .....4-16
- Counter Area.....5-4
  - Resetting or maintaining .....5-16
  - Types .....5-15
- Counter Completion Flags .....5-4
- Counter PVs.....5-4
- Counting ranges.....11-10

## CPU Unit

- I/O allocation .....6-3
- Internal memory .....2-2
- Memory areas and stored data .....2-3
- Operating modes.....3-3
- Operation.....3-2
- CTBL instruction .....11-21
- CX-Programmer
  - Help.....19-7
- Cycle time .....3-2
  - I/O response time.....A-80
  - Interrupt response time .....A-82
- Cycle time response performance .....A-80
- Cyclic refreshing .....4-15

## D

- Data formats .....4-13
- Data Memory Area.....5-3, 5-11
- Data refresh method .....14-23
- Defining origin position.....12-20
  - Operating mode.....12-25
  - Operation pattern .....12-30
  - Origin return .....12-32
  - Origin search operation setting .....12-29
  - PLC Setup .....12-21
- Differential phase input (4x).....11-8
- DM Area capacity.....1-2
- DM backup function .....16-8

## E

- End code(No-protocol communications).....14-8
- Equals Flag(P\_EQ) .....5-19
- Error Flag(P\_ER) .....5-19
- E-type CPU Unit.....1-2
- Execute process settings .....7-3

## F

- FINS command .....14-4, 14-31
- Forced set/reset .....18-11, 18-15, 19-26
- Functions allocation
  - Selecting functions in the PLC Setup .....8-4
  - Specifying method.....8-4

## G

- Global symbols .....4-6
- Greater Than Flag(P\_GT).....5-19
- Greater Than or Equals Flag(P\_GE) .....5-20

## H

- High-speed counter interrupts.....11-2, 11-14
  - Application example .....11-27
  - Functions allocation.....11-4
  - PLC Setup .....11-3, 11-16
  - Related Auxiliary Area.....11-26
  - Specifications .....11-7
  - Writing the ladder program.....11-6, 11-16
- High-speed counter settings .....7-11
- High-speed counters
  - Counting ranges .....11-10
  - Frequency measurement .....11-13

Pulse input methods .....	11-8
Reading the present value.....	11-12
Reset method .....	11-11
Holding Area.....	5-3, 5-9
Host Link .....	14-4, 14-31
Host Link command.....	14-4, 14-31

## I

I/O allocation .....	6-2
CPU Unit.....	6-3
Expansion I/O Unit.....	6-4
Expansion Unit .....	6-6
I/O memory.....	3-3, 5-2
Backup time.....	3-7
I/O memory Areas .....	5-6
Initializing method .....	3-8
I/O refresh .....	3-2
I/O refresh timing.....	4-15
I/O response time.....	A-80
Immediate refresh .....	4-15
Increment pulse input.....	11-8
Indirect addressing.....	5-12
INI instruction .....	11-22, 12-11, 13-3
Input constant.....	7-4
Input constant setting .....	A-81
Input interrupts .....	10-5
Functions allocation .....	10-5
PLC Setup .....	10-4
Writing the ladder program .....	10-5
Input-differentiated instructions .....	4-11
instruction functions.....	A-2
Instructions	
Basic understanding .....	4-8
Execution conditions.....	4-10
Operands.....	4-9
Specifying addresses .....	4-12
Variations.....	4-10
Internal memory .....	2-2
Interrupt input settings.....	7-12
Interrupt response time .....	A-82
Interrupt task .....	10-11
Interrupt task priority and order of execution.....	10-13
Interrupt task with maximum processing time (A441CH).....	10-13
Interrupts	
Input interrupts.....	10-3
Precautions.....	10-13
Scheduled interrupts.....	10-10
Types.....	10-2
Interrupts functions	
Interrupt response time.....	A-82
IORF instruction(I/O refresh).....	4-15

## J

Jogging.....	12-17
Application example .....	12-17

## L

Ladder program	
Editing.....	19-16
Input.....	19-8
Saving and reading.....	19-15
Transferring .....	19-19
Writing .....	19-8
Less Than Flag(P_LT).....	5-20

Less than or Equals Flag(P_LE) .....	5-20
Linear mode(high-speed counter) .....	11-10
Local symbols.....	4-6

## M

Maximum interrupt task processing time(A440CH) ...	10-13
Memory areas and stored data .....	2-3
Modbus-RTU Easy Master.....	14-3
DM fixed allocation words.....	5-12, 14-12
Error codes .....	14-13
Programming examples.....	14-14
Related Auxiliary Area .....	14-13
Monitor mode .....	3-3
Monitoring and debugging.....	19-24
Forced set/reset.....	19-26
Monitoring status .....	19-24
Online editing.....	19-27
MSKS instruction.....	10-6, 10-11

## N

N/NA-type CPU Unit.....	1-2
Negative Flag(P_N).....	5-20
Non-differentiated instructions.....	4-10
No-protocol communications.....	14-3, 14-8
PLC Setup .....	14-9
Related Auxiliary Area .....	14-10
Not Equal Flag(P_NE).....	5-20
Number of connected Units.....	6-3

## O

Online editing .....	18-8, 19-27
Operands.....	4-9
Operating mode at startup.....	7-3
Operating modes	
Changing method .....	3-3
Operating modes and operation .....	3-4
The retaining of I/O memory when changing.....	3-4
Operation for power interruptions.....	A-85
Timing Chart .....	A-86
ORG instruction.....	12-11, 12-24, 12-32
Origin return settings .....	7-14, 7-16
Origin search settings.....	7-13, 7-15
OUT instruction .....	12-11, 12-24
Output interrupts.....	10-2
Overflow Flag(P_OF) .....	5-20

## P

P_AER(Access Error Flag).....	5-19
P_CY(Carry Flag).....	5-19
P_EQ(Equals Flag) .....	5-19
P_ER(Error Flag).....	5-19
P_GE(Greater Than or Equals Flag).....	5-20
P_GT(Greater Than Flag) .....	5-19
P_LE(Less than or Equals Flag) .....	5-20
P_LT(Less Than Flag).....	5-20
P_N(Negative Flag).....	5-20
P_NE(Not Equal Flag).....	5-20
P_OF(Overflow Flag) .....	5-20
P_Off(Always OFF Flag) .....	5-19
P_On(Always ON Flag) .....	5-19
P_UF(Underflow Flag).....	5-20
Peripheral servicing.....	3-2
Phase-Z signal + software reset.....	11-11
PID temperature control .....	16-2
PIDAT instruction .....	16-3



PLC Setup	7-2
Base Settings	7-13, 7-14
Communications settings	7-5, 7-8
Execute process settings	7-3
High-speed counter settings	7-11
Input constant	7-4
Interrupt input settings	7-12
Origin return settings	7-16
Origin search settings	7-13, 7-14, 7-15
Settings	7-3
Startup data read setting	7-3
Startup mode setting	7-3
Timing and interrupt settings	7-3
PLS2 instruction	12-11, 12-13
Positioning control	12-13
Positioning control (independent mode)	12-52
Precautions	
Ladder programming precautions	4-22
Precautions for using interrupts	10-13
Special program sections	4-22
Program capacity	1-2, 4-3
Program mode	3-3
Program-free communications with PTs	14-5
PLC Setup and PT system settings	14-6
Programmer device	19-4
Programming	4-2
PRV instruction	11-12, 12-11, 12-34
Pulse + Direction input	11-9
Pulse input methods	11-8
Pulse output change response time	A-84
Pulse output Start Time	A-84
Pulse outputs	12-2
Application example	12-36
Changing the present value of the pulse output	12-33
Defining origin position	12-20
Functions allocation	12-3, 12-5
Jogging	12-17
Output pattern	12-50
PLC Setup	12-4
Positioning control	12-13
Positioning control (independent mode)	12-52
Precautions when using pulse outputs	12-45
Reading the pulse output present value	12-34
Related Auxiliary Area	12-35
Specifications	12-12
Speed control (continuous mode)	12-50
Triangular control	12-53
Writing the ladder program	12-11
PWM instruction	13-3
PWM outputs	13-2

## Q

Quick-response inputs	9-2
Functions allocation	9-4
PLC Setup	9-3
Writing the ladder program	9-4

## R

Range comparison	11-14, 11-20
Read protection	16-12
Relative coordinates	12-13
Relative positioning	12-13
Run mode	3-3

## S

Scheduled interrupts	10-10
Writing the ladder program	10-11
Sections	4-2, 4-6
Security function	16-12
Self-diagnosis	3-2
Serial communications	
Connecting the host computer	14-31
Modbus-RTU Easy Master	14-10, 14-11
No-protocol communications	
with general components	14-8
Program-free communications with PTs	14-5
Serial PLC Links	14-20
Types of communication	14-3
Serial Option Port	7-8
Serial PLC Link response performance	A-83
Serial PLC Links	14-3, 14-20
Allocated words	14-26
Data refresh method	14-23
Example application	14-29
PLC Setup	14-21
Related Auxiliary Area	14-27
Software reset	11-12
Specifying addresses	4-12
Specifying offsets for addresses	4-19
SPED instruction	12-11, 12-17
Speed control (continuous mode)	12-50
Startup data read setting	7-3
Step ladder program sections	4-23
Subroutines	4-2, 4-22
Switching from speed control (continuous mode)	
to positioning (independent mode)	12-57
Symbols	
Global symbols	4-6
Local symbols	4-6

## T

Target value comparison	11-14, 11-17
Tasks	4-2, 4-6
Timer Area	5-3
PV refresh method	5-14
Resetting or maintaining	5-14
Types	5-13
Timing and interrupt settings	7-3
Triangular control	12-53

## U

Underflow Flag(P_UF)	5-20
Up/Down pulse input	11-8

## V

Variable-duty-factor pulse outputs(PWM outputs)	13-2
Variations	4-10

## W

Word address	5-5
Work Area	5-3, 5-8



# Revision History

---

A manual revision code appears as a suffix to the catalog number on the front cover of the manual.

Cat. No. W480-E1-09

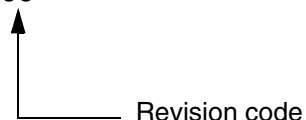

Revision code	Date	Revised content
01	March 2009	Original production
02	June 2009	<ul style="list-style-type: none"><li>Information added on pulse outputs and PWM outputs.</li><li>Information added on CX-Programmer Micro PLC Edition version 8.2 upgrading to version 9.0.</li></ul>
03	January 2010	Information added on E10/14, N14/60 and NA20 CPU Units.
04	June 2010	<ul style="list-style-type: none"><li>CP1W-DA021 added for CP-series Expansion Units.</li><li>Information added on CP1W-CIF41 Ethernet Option Board.</li></ul>
05	November 2012	Information added on N□□S(1)-type and E□□S-type CPU Units.
06	June 2014	Information added on CP1W-ADB21/DAB21V/MAB221 Analog Option Board.
07	November 2014	CP1W-AD042 Analog Input Units, CP1W-DA042 Analog Output Units, CP1W-MAD42/MAD44 Analog I/O Units and CP1W-TS003/TS004 Temperature Sensor Units added for CP-series Expansion Units.
08	January 2016	<ul style="list-style-type: none"><li>Added CP1E CPU Units with unit version 1.3.</li><li>Errors were corrected.</li></ul>
09	September 2022	Revisions for adding safety precautions regarding security.





**OMRON Corporation Industrial Automation Company**

**Kyoto, JAPAN**

**Contact : [www.ia.omron.com](http://www.ia.omron.com)**

**Regional Headquarters**

**OMRON EUROPE B.V.**

Wegalaan 67-69, 2132 JD Hoofddorp  
The Netherlands  
Tel: (31) 2356-81-300 Fax: (31) 2356-81-388

**OMRON ASIA PACIFIC PTE. LTD.**

438B Alexandra Road, #08-01/02 Alexandra  
Technopark, Singapore 119968  
Tel: (65) 6835-3011 Fax: (65) 6835-2711

**OMRON ELECTRONICS LLC**

2895 Greenspoint Parkway, Suite 200  
Hoffman Estates, IL 60169 U.S.A.  
Tel: (1) 847-843-7900 Fax: (1) 847-843-7787

**OMRON (CHINA) CO., LTD.**

Room 2211, Bank of China Tower,  
200 Yin Cheng Zhong Road,  
PuDong New Area, Shanghai, 200120, China  
Tel: (86) 21-5037-2222 Fax: (86) 21-5037-2200

**Authorized Distributor:**

©OMRON Corporation 2009-2022 All Rights Reserved.  
In the interest of product improvement,  
specifications are subject to change without notice.

**Cat. No. W480-E1-09 0922**